



# **Agilent 7697A Headspace Sampler**

## **Maintenance**

# Notices

© Agilent Technologies, Inc. 2012

No part of this manual may be reproduced in any form or by any means (including electronic storage and retrieval or translation into a foreign language) without prior agreement and written consent from Agilent Technologies, Inc. as governed by United States and international copyright laws.

## Manual Part Number

G4556-90017

## Edition

Third edition, February 2012  
Second edition, November 2011  
First edition, February, 2011

Printed in USA

Agilent Technologies, Inc.  
2850 Centerville Road  
Wilmington, DE 19808-1610 USA

安捷伦科技（上海）有限公司  
上海市浦东新区外高桥保税区  
英伦路 412 号  
联系电话：（800）820 3278

## Warranty

**The material contained in this document is provided “as is,” and is subject to being changed, without notice, in future editions. Further, to the maximum extent permitted by applicable law, Agilent disclaims all warranties, either express or implied, with regard to this manual and any information contained herein, including but not limited to the implied warranties of merchantability and fitness for a particular purpose. Agilent shall not be liable for errors or for incidental or consequential damages in connection with the furnishing, use, or performance of this document or of any information contained herein. Should Agilent and the user have a separate written agreement with warranty terms covering the material in this document that conflict with these terms, the warranty terms in the separate agreement shall control.**

## Safety Notices

### CAUTION

A CAUTION notice denotes a hazard. It calls attention to an operating procedure, practice, or the like that, if not correctly performed or adhered to, could result in damage to the product or loss of important data. Do not proceed beyond a CAUTION notice until the indicated conditions are fully understood and met.

### WARNING

A WARNING notice denotes a hazard. It calls attention to an operating procedure, practice, or the like that, if not correctly performed or adhered to, could result in personal injury or death. Do not proceed beyond a WARNING notice until the indicated conditions are fully understood and met.

# Contents

## 1 About Maintaining the Headspace Sampler

- Overview of Maintenance 6
  - Where to find a procedure 6
  - Early Maintenance Feedback feature 6
- Tools and Materials Required for Maintenance 7
- Safety 8

## 2 Removing Covers and Components

- To Remove the Pneumatics Front Cover 10
- To Remove the Valve Thermal Enclosure 11
- To Install the Valve Thermal Enclosure 12
- To Remove the Pneumatics Assembly 13
- To Remove the Valve Cover 17
- To Remove the Loop Cover 18
- To Remove the Valve/Loop Cover 19
- To Remove the Tray Assembly (111-Vial Model) 20
- To Remove the Rotating Top Cover (12-Vial Model) 22

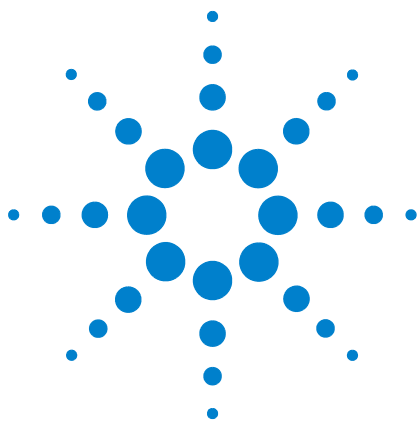
## 3 Maintenance

- To Clean the Sample Tray (12-Vial Model) 24
- To Replace the Sample Tray Seals (12-Vial Model) 26
- To Clean the Sample Tray Assembly (111-Vial Model) 27
- To Clean the Oven (111-Vial Model) 29
- To Replace the Sample Probe 34
- To Replace the Sample Loop 37
- To Replace the Sample Loop Adapters 42
- To Replace the 6 Port Valve 45
- To Replace the 6 Port Valve Rotor 46
- To Clean the 6 Port Valve and Rotor 49
- To Attach the Transfer Line to a Split Splitless or Multimode Inlet 50
- To Attach the Transfer Line to a Volatiles Interface 52
- To Attach the Transfer Line to a Purged Packed Inlet 55

To Attach the Transfer Line to a Cool On-Column Inlet	57
To Remove the Fused Silica Column from the Transfer Line	59
To Install a Fused Silica Column into the Transfer Line	61
To Use ProSteel Tubing	66

#### **4 Consumables and Parts**

Consumables and Parts for the Agilent 7697A Headspace Sampler	68
---	----



# 1 About Maintaining the Headspace Sampler

Overview of Maintenance 6

Tools and Materials Required for Maintenance 7

Safety 8

This section provides an overview of the maintenance procedures included in this document. It also lists the tools needed for routine maintenance and the safety information one should be aware of before performing a maintenance task.



## Overview of Maintenance

This manual details the routine tasks needed to maintain the 7697A Headspace Sampler (Headspace). The procedures assume a basic knowledge of tool use and of Headspace operation. Readers are, for example, expected to know how to:

- Safely turn devices on and off
- Prepare and run samples
- Enter and develop methods
- Make typical pneumatic connections using Swagelok and other standard fittings

### Where to find a procedure

Included in this manual are sections on maintaining the following Headspace components:

- Fused silica column
- Transfer line
- Sample needle
- Sample loop
- 6 port valve
- Oven
- Vial racks

### Early Maintenance Feedback feature

Both the Headspace and Agilent Instrument Utilities include the capability to alert users of upcoming maintenance needs. This feature, called Early Maintenance Feedback, notifies users when a counter (such as a gripper pad counter, valve loop counter, or probe cycle counter) has reached the specified maintenance point. After performing the required maintenance, reset the applicable counter. Refer to the *Operation manual* for details about this feature.

## Tools and Materials Required for Maintenance

Table 1 lists the tools needed for most Headspace maintenance procedures. The specific tools required to perform a maintenance procedure are listed in step 1 of the procedure.

**Table 1** Required Tools

<b>Tool</b>	<b>Description</b>
T- 20 Torx Driver	
T- 20 Torx Key	(for working in limited space)
Long T- 20 Torx Driver	
T- 10 Torx Driver	
T- 10 Torx Key	(for working in limited space)
Small cross head screwdriver	
Large cross head screwdriver	
Needle nose pliers	

## **Safety**

Before performing a maintenance task, read the important safety and regulatory information found in the *7697A Headspace Sampler Safety* manual.





## 2 Removing Covers and Components

To Remove the Pneumatics Front Cover	10
To Remove the Valve Thermal Enclosure	11
To Install the Valve Thermal Enclosure	12
To Remove the Pneumatics Assembly	13
To Remove the Valve Cover	17
To Remove the Loop Cover	18
To Remove the Valve/Loop Cover	19
To Remove the Tray Assembly (111-Vial Model)	20
To Remove the Rotating Top Cover (12-Vial Model)	22

This section describes how to remove covers and components as needed for routine maintenance.

Only the covers and components listed in this chapter should be removed. Removing other Headspace covers can compromise the safety features of the instrument, leading to personal injury or damage to the instrument.



## To Remove the Pneumatics Front Cover

The pneumatics front cover protects the valve thermal enclosure and transfer line. To remove the pneumatics front cover:

- 1 Press [Tray Park/Carousel Advance] to “park” the tray (if available).
- 2 Remove the T-20 screw that secures the cover in place (Figure 1).



**Figure 1** Remove the T-20 Torx screw from the pneumatics front cover

- 3 Slide the cover out, then lift to remove.  
Reinstallation is the reverse of these steps.

## To Remove the Valve Thermal Enclosure

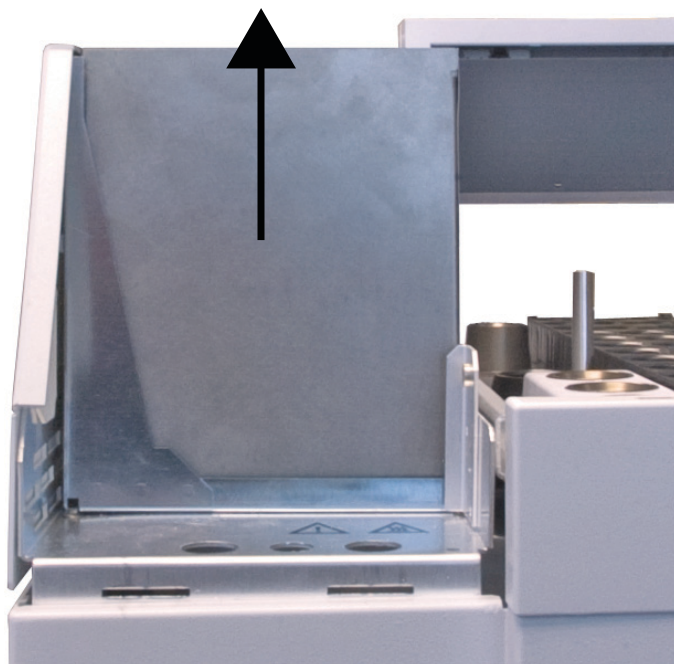
The valve thermal enclosure protects the 6 port valve and sample loop. To remove the valve thermal enclosure:

- 1 Remove the pneumatics front cover. See [“To Remove the Pneumatics Front Cover”](#).

**WARNING**

The valve thermal enclosure and its contents may be hot enough to cause burns.

- 2 Cool down the sample loop and sample probe to a safe handling temperature. If you will disconnect the transfer line from the Headspace, cool down the transfer line and GC column oven as needed.
- 3 Carefully lift the valve thermal enclosure straight up and off of the headspace sampler ([Figure 2](#)).

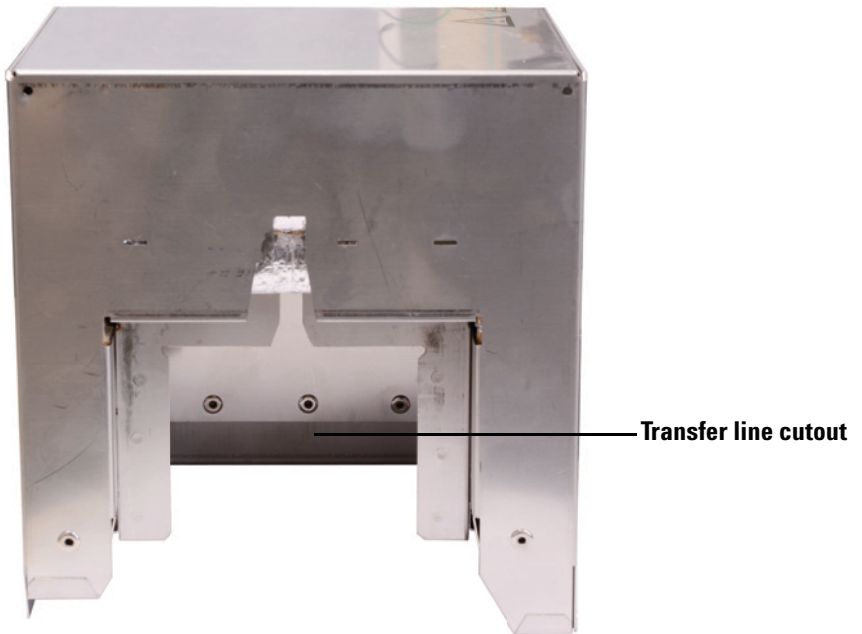


**Figure 2** Lift the valve thermal enclosure straight up

## To Install the Valve Thermal Enclosure

To install the valve thermal enclosure:

- 1 Locate the valve thermal enclosure's transfer line cutout, and align it with the transfer line (Figure 3).



**Figure 3** The valve thermal enclosure's transfer line cutout

- 2 Carefully lower the valve thermal enclosure over the valve and loop areas with the transfer line cutout facing the left side of the Headspace.

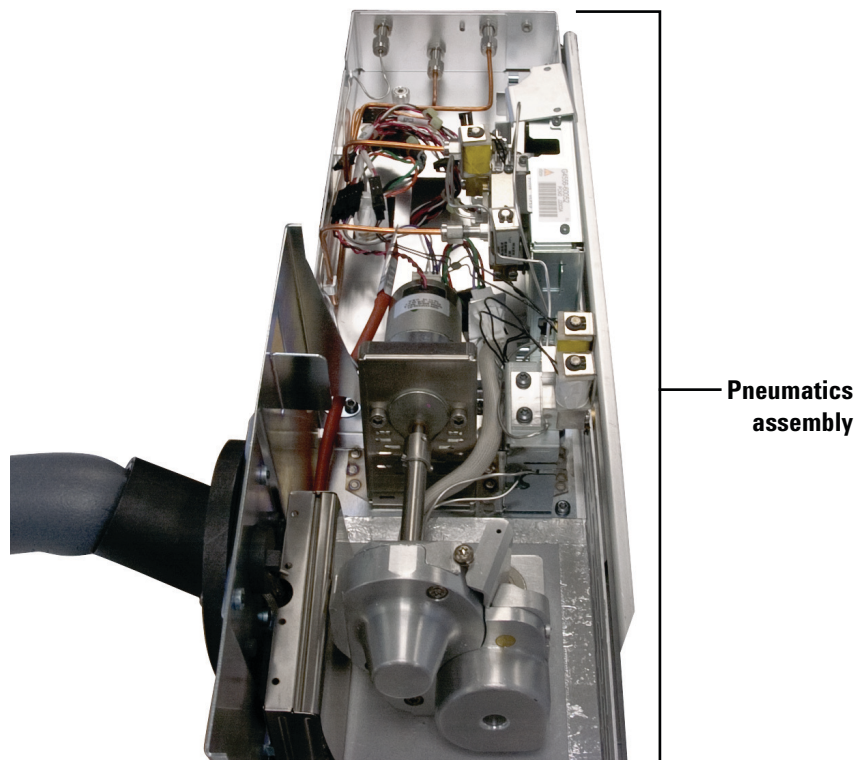
**CAUTION**

Be sure to not damage the transfer line and other nearby cables when lowering the valve thermal enclosure.

---

## To Remove the Pneumatics Assembly

Remove the pneumatics assembly (Figure 4) to access the oven components.



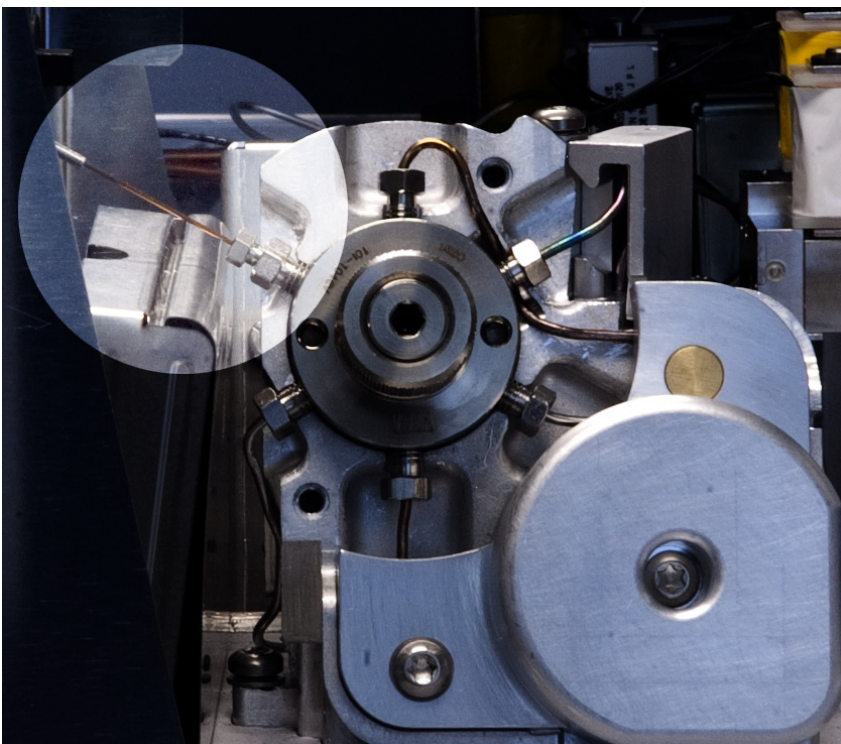
**Figure 4** Pneumatics assembly without covers

To remove the pneumatics assembly:

- 1 Set your GC oven, Headspace oven, and transfer line to ambient temperatures and wait for them to cool.
- 2 Once the GC oven, Headspace oven, and transfer line have cooled to ambient temperature, turn the Headspace off and unplug the power cord.
- 3 Turn all gas flows off at their sources, and if necessary, disconnect the gas lines at the pneumatics assembly back panel.
- 4 Remove the pneumatics assembly front cover. See [“To Remove the Pneumatics Front Cover”](#).

## 2 Removing Covers and Components

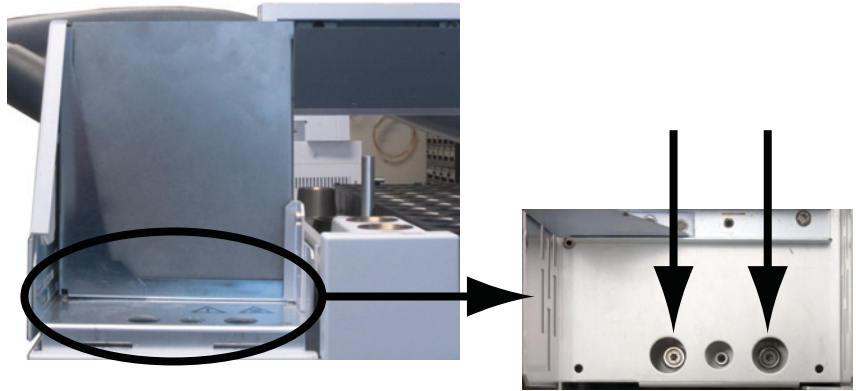
- 5 If necessary, disconnect the transfer line from the pneumatics assembly or GC.
  - a Remove the valve thermal enclosure. See “[To Remove the Valve Thermal Enclosure](#)”.
  - b Depending on your hardware configuration, remove the valve cover, or the valve/loop cover. See “[To Remove the Valve Cover](#)” or “[To Remove the Valve/Loop Cover](#)”.
  - c Loosen the 3/16-inch nut in the internal reducer ([Figure 5](#)).



**Figure 5** 3/16-inch internal reducer with valve cover removed and loop cover shown (the valve/loop cover is similar)

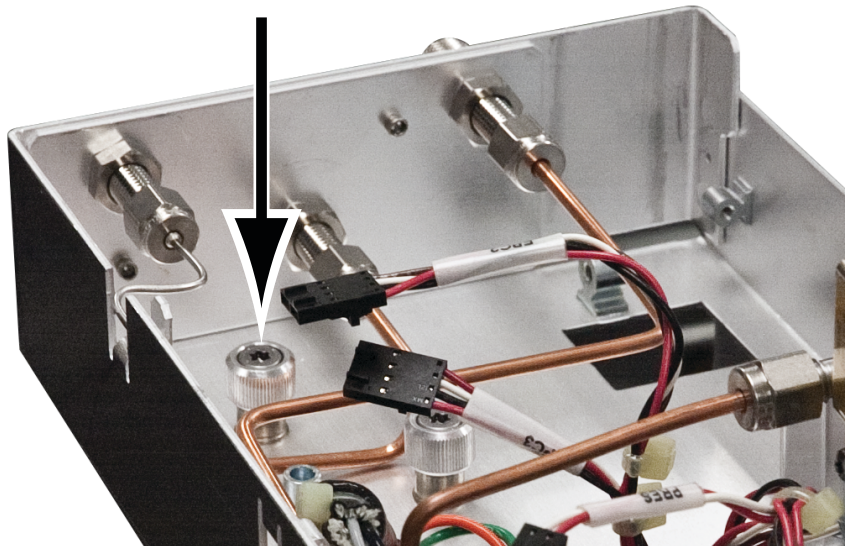
- d Remove the fused silica column from the internal reducer.
      - e Hold the transfer line by the mounting bracket, and carefully slide the transfer line out of the Headspace and set it aside.

- 6 Completely loosen the two T-20 Torx captive thumbscrews that are inset at the front of the pneumatics assembly (Figure 6).



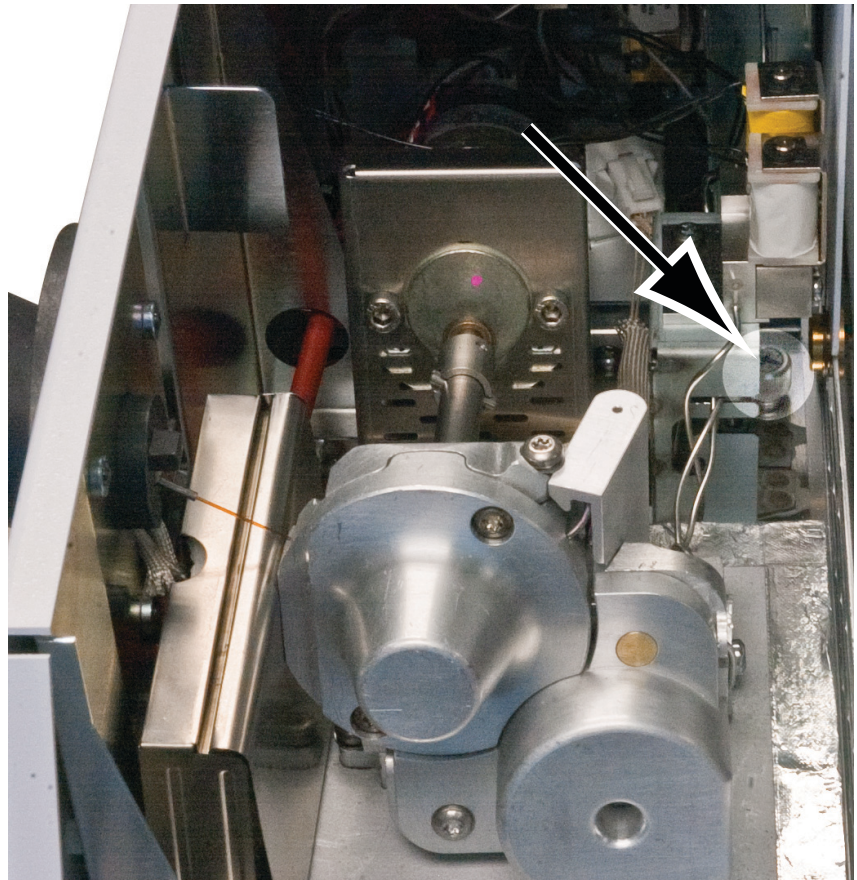
**Figure 6** Locate and loosen the two front thumbscrews

- 7 Completely loosen the T-20 Torx captive thumbscrew at the back of the pneumatics assembly (Figure 7).



**Figure 7** Overhead view of the back thumbscrew securing the pneumatics assembly

- 8 Completely loosen the T-20 Torx captive thumbscrew at the middle of the pneumatics assembly near the two proportional valves (Figure 8).



**Figure 8** Overhead view of the middle thumbscrew securing the pneumatics assembly

### CAUTION

Do not remove the pneumatics assembly completely. Be careful to not damage any attached cables and gas lines when moving the pneumatics assembly.

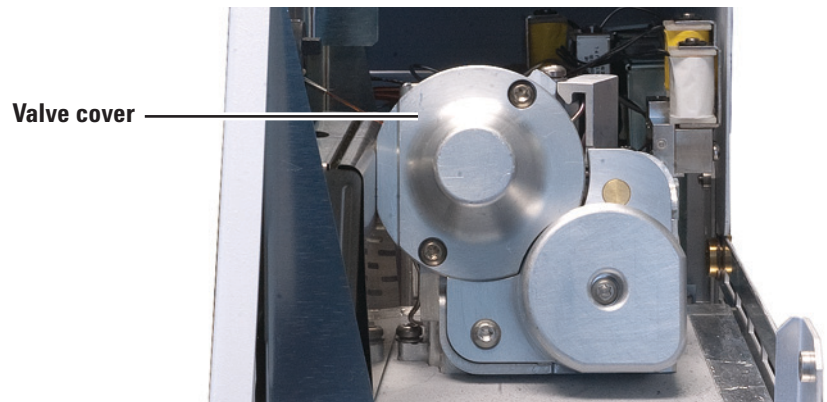
- 9 Lift the pneumatics assembly straight up, rotate the assembly about 90-degrees counterclockwise, and lay it across the back of the Headspace.

Reinstallation is the reverse of these steps.



## To Remove the Valve Cover

- 1 Gather the following:
  - T-20 Torx driver
- 2 Remove the pneumatics front cover. See [“To Remove the Pneumatics Front Cover”](#).
- 3 Remove the valve thermal enclosure. See [“To Remove the Valve Thermal Enclosure”](#).
- 4 Completely loosen the two T-20 Torx captive screws on the valve cover ([Figure 9](#)).



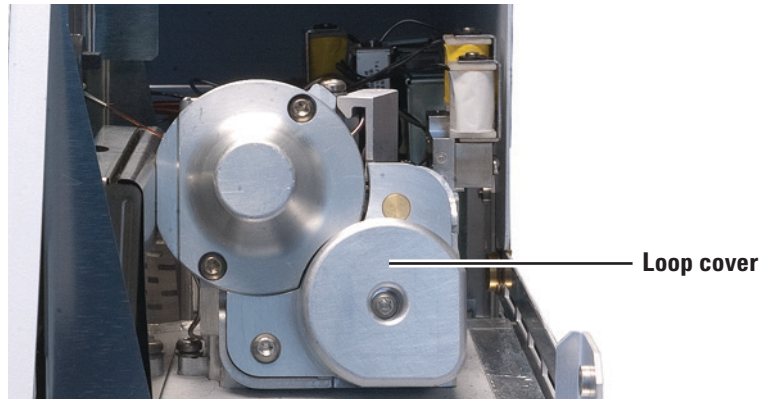
**Figure 9** Valve cover

- 5 Remove the valve cover.

Reinstallation is the reverse of these steps.

## To Remove the Loop Cover

- 1 Gather the following:
  - T-20 Torx driver
- 2 Remove the pneumatics front cover. See “[To Remove the Pneumatics Front Cover](#)”.
- 3 Remove the valve thermal enclosure. See “[To Remove the Valve Thermal Enclosure](#)”.
- 4 Completely loosen the T-20 Torx captive screw on the loop cover ([Figure 10](#)).



**Figure 10** Loop cover

- 5 Remove the loop cover.

Reinstallation is the reverse of these steps.

## To Remove the Valve/Loop Cover

- 1 Gather the following:
  - T-20 Torx driver
- 2 Remove the pneumatics front cover. See [“To Remove the Pneumatics Front Cover”](#).
- 3 Remove the valve thermal enclosure. See [“To Remove the Valve Thermal Enclosure”](#).
- 4 Completely loosen the three T-20 Torx captive screws on the valve/loop cover ([Figure 11](#)).



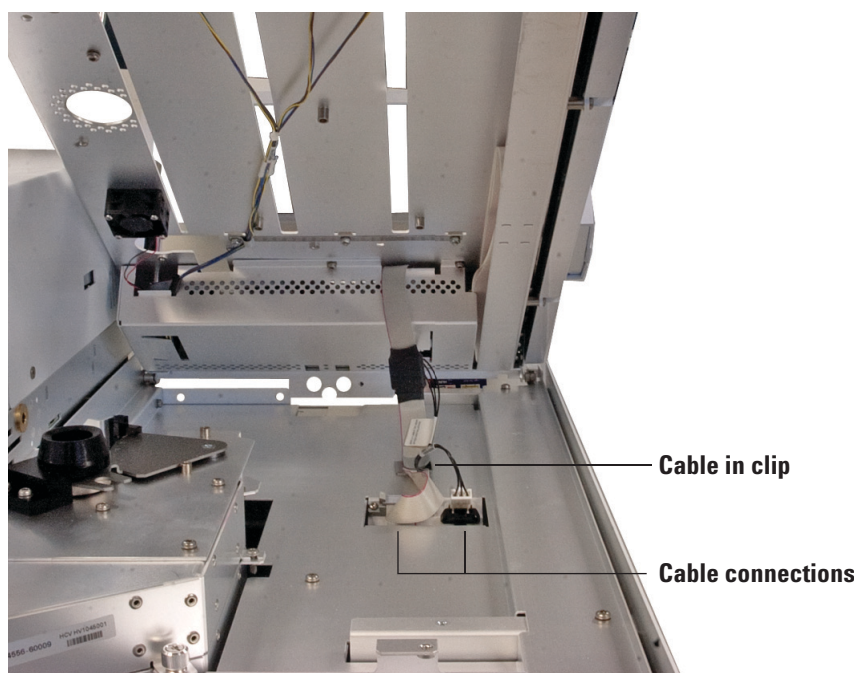
**Figure 11** Valve/loop cover

- 5 Remove the valve/loop cover.

Reinstallation is the reverse of these steps.

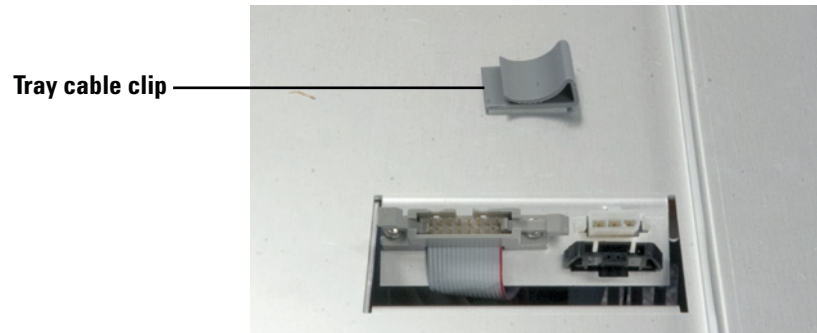
## To Remove the Tray Assembly (111-Vial Model)

- 1 Gather the following:
  - Lint-free gloves
- 2 Set your GC oven, Headspace oven, and transfer line to ambient temperatures and wait for them to cool.
- 3 Once the GC oven, Headspace oven, and transfer line have cooled to ambient temperature, turn the Headspace off and unplug the power cord.
- 4 Turn all gas flows off at their sources.
- 5 Remove all sample vials and vial racks.
- 6 Lift the front of the tray assembly up and disconnect the two cable connections underneath the tray (Figure 12).



**Figure 12** Tray cable connections

- 7 Slide the cables out of the tray cable clip (Figure 13).



**Figure 13** Tray cable clip

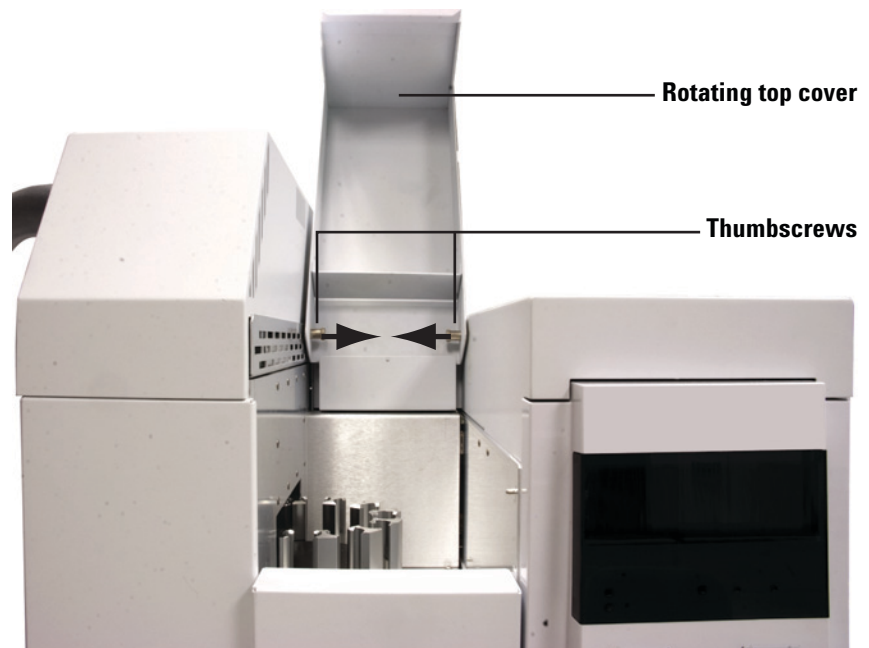
- 8 Lift the tray assembly off of the Headspace and place it on a flat surface.

Reinstallation is the reverse of these steps.

## To Remove the Rotating Top Cover (12-Vial Model)

The rotating top cover protects the carousel on the 12-vial model Headspace sampler. To remove the rotating top cover:

- 1 Power off the Headspace and disconnect the power cord.
- 2 Lift the rotating top cover from the front so that the two thumbscrews are accessible underneath.
- 3 Unhinge and remove the rotating top cover by pulling one of the two thumbscrews inward while lifting the cover off of the chassis (Figure 14). Once the thumbscrew disconnects, repeat the same action for the second thumbscrew.



**Figure 14** Removing the rotating top cover (12-vial model)

- 4 Remove the rotating top cover.

Reinstallation is the reverse of these steps.



## 3 Maintenance

- To Clean the Sample Tray (12-Vial Model) 24
- To Replace the Sample Tray Seals (12-Vial Model) 26
- To Clean the Sample Tray Assembly (111-Vial Model) 27
- To Clean the Oven (111-Vial Model) 29
- To Replace the Sample Probe 34
- To Replace the Sample Loop 37
- To Replace the Sample Loop Adapters 42
- To Replace the 6 Port Valve 45
- To Replace the 6 Port Valve Rotor 46
- To Clean the 6 Port Valve and Rotor 49
- To Attach the Transfer Line to a Split Splitless or Multimode Inlet 50
- To Attach the Transfer Line to a Volatiles Interface 52
- To Attach the Transfer Line to a Purged Packed Inlet 55
- To Attach the Transfer Line to a Cool On-Column Inlet 57
- To Remove the Fused Silica Column from the Transfer Line 59
- To Install a Fused Silica Column into the Transfer Line 61
- To Use ProSteel Tubing 66

This section provides the basic maintenance procedures for the Agilent 7697A Headspace Sampler.



## To Clean the Sample Tray (12-Vial Model)

**CAUTION**

Wear clean, lint-free gloves to prevent contamination of parts with dirt and skin oils.

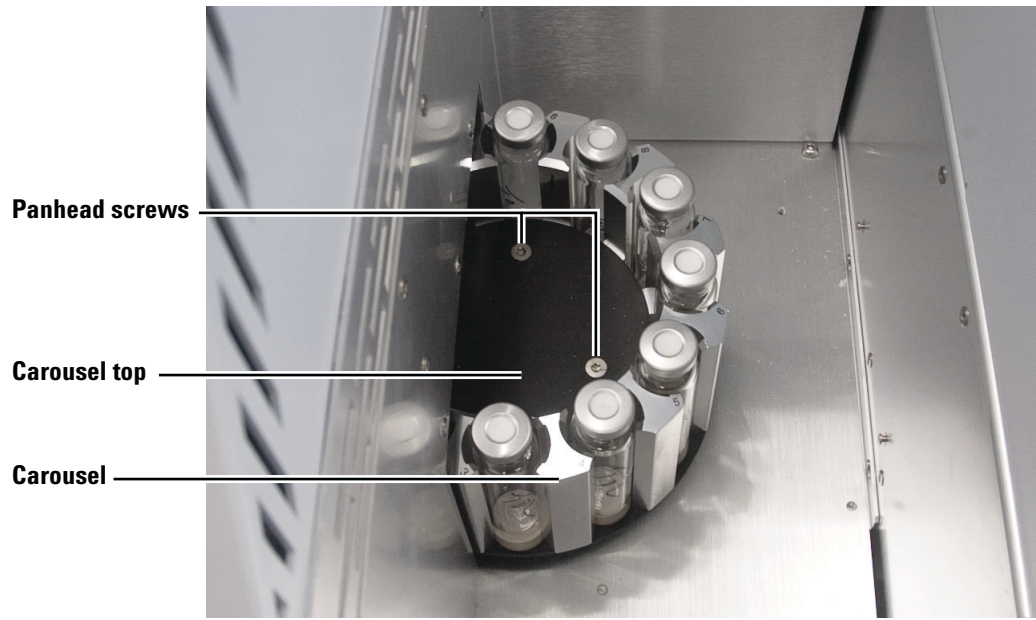
---

The following instructions describe how to clean the 12-vial model sample tray (carousel).

- 1 Gather the following:
  - Lint-free gloves
  - T-20 Torx driver
  - Lint-free cloth
  - Vacuum cleaner
- 2 Remove the rotating top cover. See [“To Remove the Rotating Top Cover \(12-Vial Model\)”](#).
- 3 Carefully remove any vials from the carousel.



- 4 Remove the carousel assembly.
  - a Remove the three T-20 Torx screws on the carousel top, and remove the carousel top (Figure 15).



**Figure 15** Oven area and carousel

- b Remove the three T-20 Torx panhead screws and washers on the carousel base that secure the carousel to the carousel hub (Figure 15).
    - c Carefully remove the carousel from the carousel hub.
- 5 Clean the vial area.
  - a Carefully remove any broken glass from the carousel and vial tray area using a vacuum cleaner.
  - b Wipe away any spills from the carousel and vial tray area using a lint-free cloth.

Reassembly is the reverse of these steps.

## To Replace the Sample Tray Seals (12-Vial Model)

The sample tray seals normally do not require replacement. However, they may need to be cleaned or replaced after cleaning up spills or other maintenance.

**WARNING**

**Vials may be hot. Before handling, allow time for vials to cool as needed. Wear heat resistant gloves as needed.**

---

- 1 Gather the following:
  - Replacement vial tray seals
- 2 Lift the rotating top cover.



- 3 Remove all vials from the carousel.
- 4 If needed, remove the old vial tray seals.
- 5 If needed, clean the tray assembly. See [“To Clean the Sample Tray \(12-Vial Model\)”](#).
- 6 Place the new sample tray seals into the vial slots in the tray.

## To Clean the Sample Tray Assembly (111-Vial Model)

**CAUTION**

Wear clean, lint-free gloves to prevent contamination of parts with dirt and skin oils.

The following describes how to clean the 111-vial model sample tray assembly.

- 1 Gather the following.
  - Lint-free gloves
  - Lint-free cloth
  - Vacuum cleaner
- 2 Clean the vial racks.
  - a Remove the vial racks from the tray assembly (Figure 16).
  - b Carefully remove all vials from the vial racks and set them aside.
  - c Remove any broken glass from the vial racks using a vacuum cleaner.
  - d Wipe away any spills from the vial racks using a lint-free cloth.



**Figure 16** Removing vial racks from the tray assembly (111-Vial Model)

- 3 Remove the tray assembly from the Headspace. See [“To Remove the Tray Assembly \(111-Vial Model\)”](#).
- 4 Clean the tray assembly using a lint-free cloth.
  - a Wipe away any spills on the surfaces of the tray assembly.
  - b Clean the priority sample area.
  - c Clean inside the vial cooling position.
  - d Clean inside the bar code reader position if applicable.
  - e Wipe away any residue on the gantry and gripper fingers.
- 5 Clean the Headspace tray surface of any spills or broken glass that may have fallen through the tray assembly base.
  - a Clean any broken glass on the Headspace tray surface using a vacuum cleaner.
  - b Wipe away any spills from the tray surface using a lint-free cloth.

Reassembly is the reverse of these steps.

## To Clean the Oven (111-Vial Model)

- 1 Gather the following:
  - Lint-free gloves
  - Lint-free wipes
  - T-20 Torx driver
  - L-shaped 3-mm Hex wrench
  - Needle nose pliers
  - Shop vacuum
- 2 Set your GC oven, Headspace oven, and transfer line to ambient temperatures and wait for them to cool.
- 3 Once the GC oven, Headspace oven, and transfer line have cooled to ambient temperature, turn the Headspace off and unplug the power cord.
- 4 Turn all gas flows off at their sources.
- 5 Remove the tray assembly. See [“To Remove the Tray Assembly \(111-Vial Model\)”](#).

**WARNING**

**Be careful! Certain parts may be hot enough to cause burns. If hot, wear heat-resistant gloves to protect your hands.**

---

- 6 Remove the pneumatics assembly. See [“To Remove the Pneumatics Assembly”](#).

7 Remove the oven top assembly.

- a Disconnect the shutter motor cable from the connector board (Figure 17).

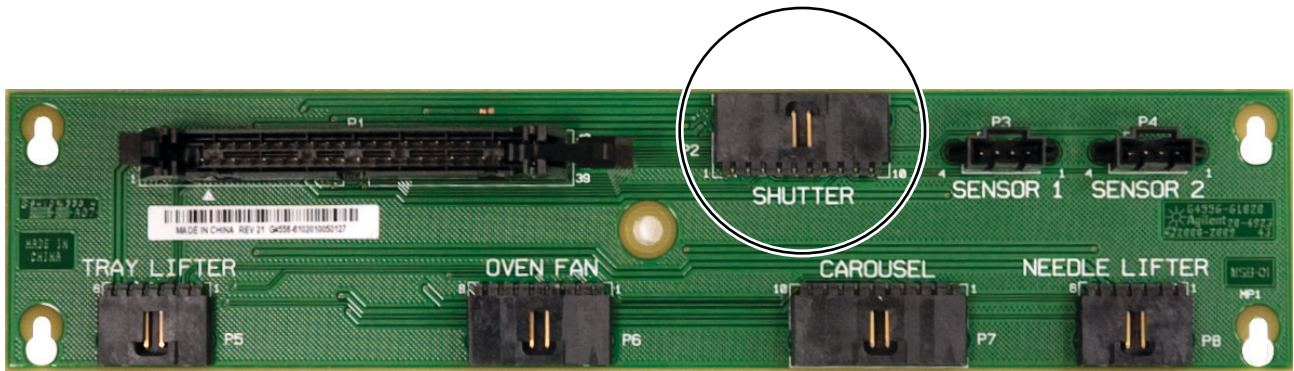


Figure 17 The connector board

- b Remove four T-20 Torx screws from the oven top assembly (Figure 18).

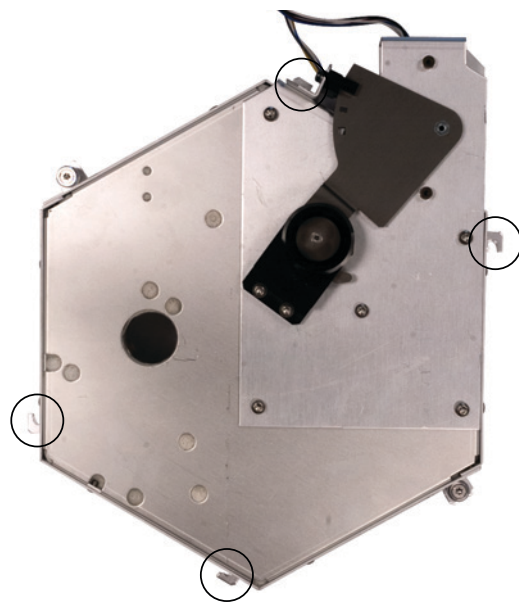
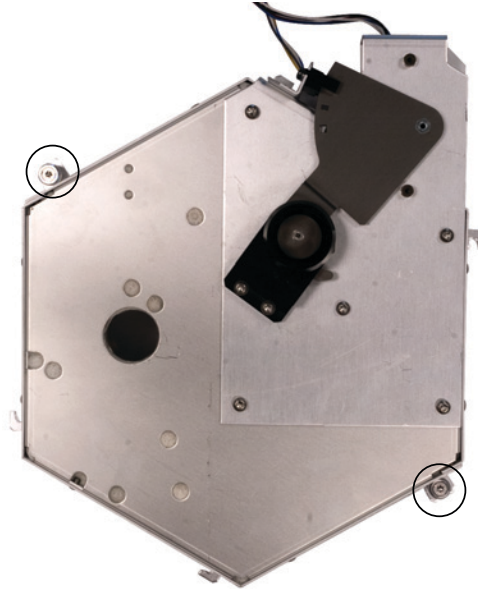


Figure 18 Remove T-20 screws from the oven top assembly

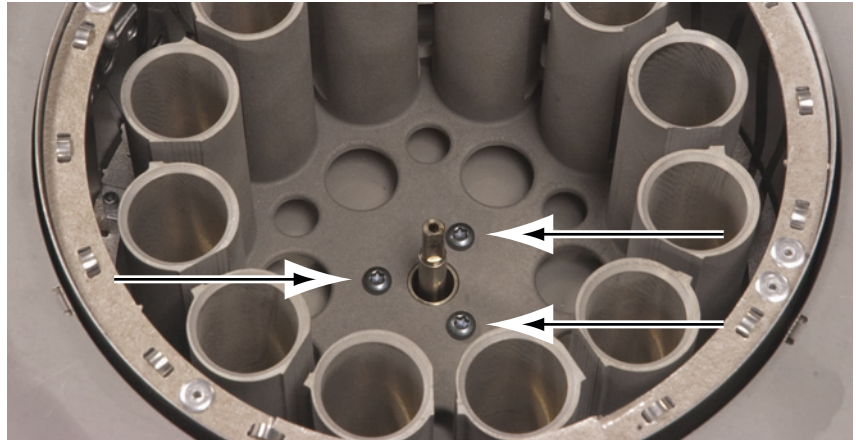
- c Completely loosen the two T-20 Torx captive thumbscrews (Figure 19).



**Figure 19** Loosen the thumbscrews on the oven top assembly

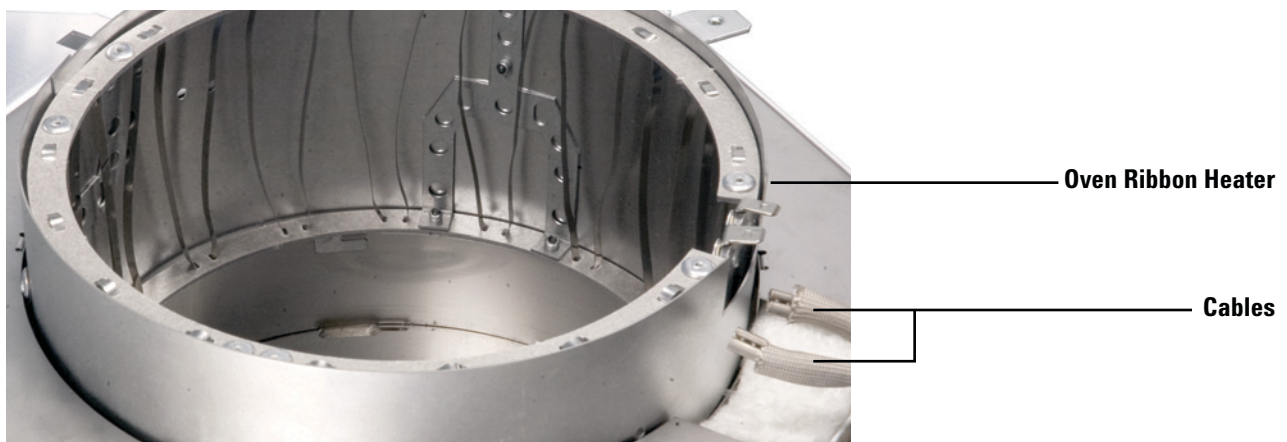
- d Lift the oven top assembly off of the oven and set it aside.

- 8 Remove the carousel assembly.
  - a Remove three T-20 Torx screws from the center of the carousel (Figure 20).



**Figure 20** Removing the carousel

- b Carefully lift the carousel out of the oven assembly.
  - c Wipe away any spills and vacuum any broken glass from the carousel assembly.
- 9 Remove the oven ribbon heater.
  - a Carefully remove the two cables attached to the oven ribbon heater using needle nose pliers (Figure 21).



**Figure 21** Removing the oven ribbon heater cables



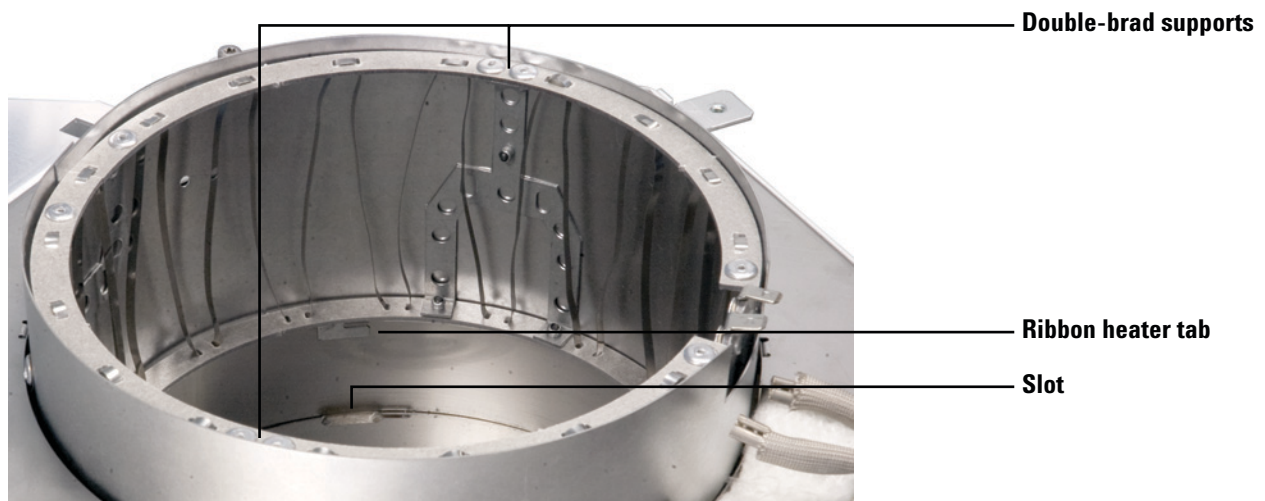
**CAUTION**

The ribbon heater edges are sharp. Wear protective gloves to avoid personal injury.

**CAUTION**

Parts of the ribbon heater are very fragile. Be careful when handling to avoid accidental damage.

- b Using both hands, hold the oven ribbon heater on the double-brad supports as shown in [Figure 22](#).



**Figure 22** Removing the oven ribbon heater

- c Rotate the oven ribbon heater in a counterclockwise direction until the feet come out of the slots, then rotate the oven ribbon heater back and forth while pulling up until the oven ribbon heater pops out.
  - d Wipe away any spills and vacuum any broken glass from the oven ribbon heater.
- 10** Wipe away any spills and vacuum any broken glass from the oven area. Be sure to check underneath the carousel hub for debris.

Reassembly is the reverse of these steps.

## To Replace the Sample Probe

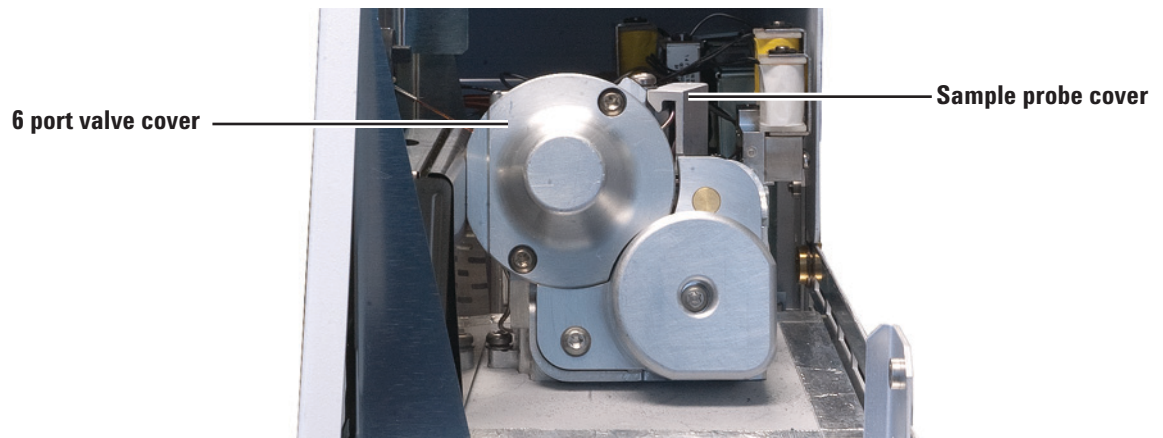
**CAUTION**

Wear clean, lint-free gloves to prevent contamination of parts with dirt and skin oils.

---

- 1 Gather the following:
  - Lint-free gloves
  - T-20 Torx driver
  - 1/4-inch wrench
- 2 Set your GC oven, Headspace oven, and transfer line to ambient temperatures and wait for them to cool.
- 3 Once the GC oven, Headspace oven, and transfer line have cooled to ambient temperature, turn the Headspace off and unplug the power cord.
- 4 Turn all gas flows off at their sources.
- 5 Access the pneumatics area:
  - a Remove the pneumatics front cover. See [“To Remove the Pneumatics Front Cover”](#).
  - b Remove the valve thermal enclosure. See [“To Remove the Valve Thermal Enclosure”](#).

- 6 Depending on your hardware configuration, do one of the following:
- Remove the loop cover and valve cover (Figure 23). See “To Remove the Loop Cover” and “To Remove the Valve Cover”.
  - Remove the valve/loop cover (Figure 24). See “To Remove the Valve/Loop Cover”.



**Figure 23** The valve and sample probe covers



**Figure 24** The valve/loop cover

- 7 Remove the sample probe cover:
- a Remove the T-20 Torx screw that secures the sample probe cover.
  - b Lift the sample probe cover from the probe (Figure 23).

- 8 Using a 1/4-inch wrench, loosen the sample probe connection on the 6 port valve and remove the sample probe fitting from the valve.
- 9 Remove the sample probe.
- 10 Check that the nut at the end of the new sample probe spins freely.
- 11 Place the new sample probe into the probe opening and gently shape the service loop until it fits into the space.
- 12 Rotate the other end of the sample probe (with nut) so that the end is near position 5 on the 6 port valve.
- 13 Finger tighten the nut onto the 6 port valve. Once the nut is well-engaged, loosen it by one rotation.
- 14 Gently push the sample probe further into position.
- 15 Tighten the nut attached to the 6 port valve using a 1/4-inch wrench.
- 16 Replace all covers, restore all gas flows, and plug in the Headspace power cord.

## To Replace the Sample Loop

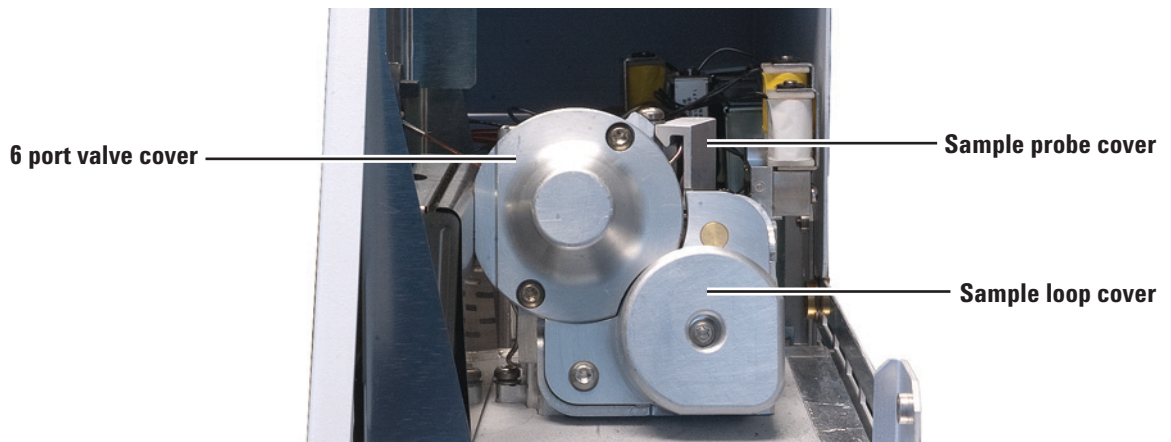
**CAUTION**

Wear clean, lint-free gloves to prevent contamination of parts with dirt and skin oils.

---

- 1 Gather the following:
  - Lint-free gloves
  - Sample loop (see [Table 7](#))
  - Sample loop adapters, as needed (see [Table 2](#))
  - T-20 Torx driver
  - 1/4-inch wrench
  - Needle nose pliers
- 2 Set your GC oven, Headspace oven, and transfer line to ambient temperatures and wait for them to cool.
- 3 Once the GC oven, Headspace oven, and transfer line have cooled to ambient temperature, turn the Headspace off and unplug the power cord.
- 4 Turn all gas flows off at their sources.
- 5 Access the pneumatics area:
  - a Remove the pneumatics front cover. See [“To Remove the Pneumatics Front Cover”](#).
  - b Remove the valve thermal enclosure. See [“To Remove the Valve Thermal Enclosure”](#).

- 6 Depending on your hardware configuration, do one of the following:
- Remove the loop cover and valve cover (Figure 25). See “To Remove the Loop Cover” and “To Remove the Valve Cover”.
  - Remove the valve/loop cover (Figure 26). See “To Remove the Valve/Loop Cover”.



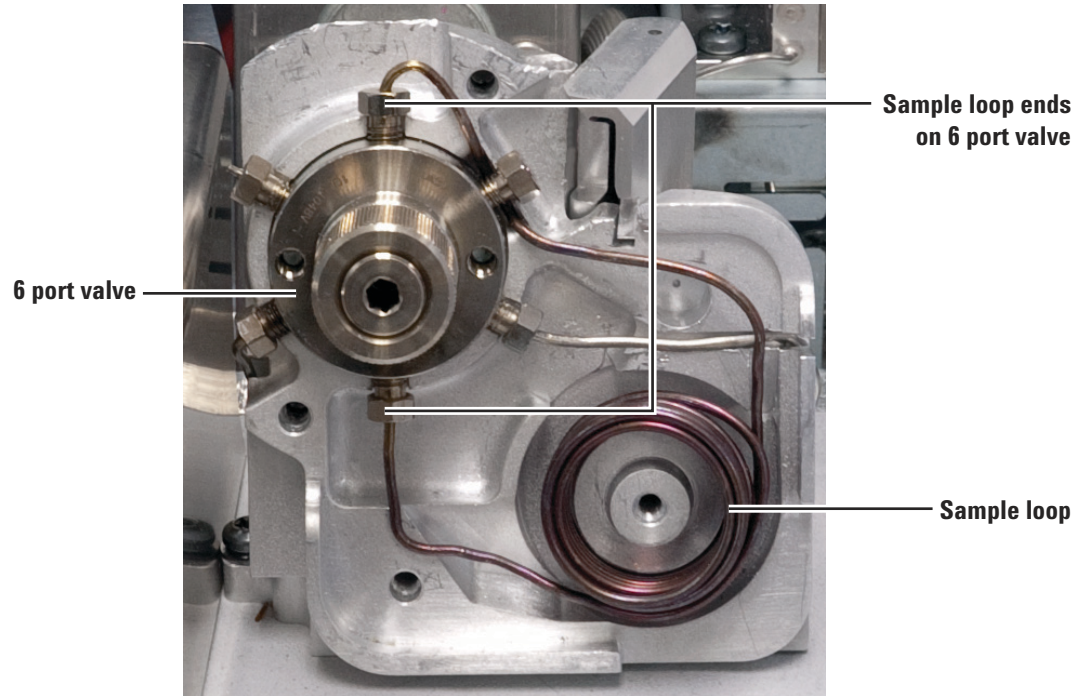
**Figure 25** The valve and loop covers



**Figure 26** The valve/loop cover

- 7 Remove the sample probe cover:
- a Remove the T-20 Torx screw that secures the sample probe cover.
  - b Lift the sample probe cover from the probe (Figure 25).

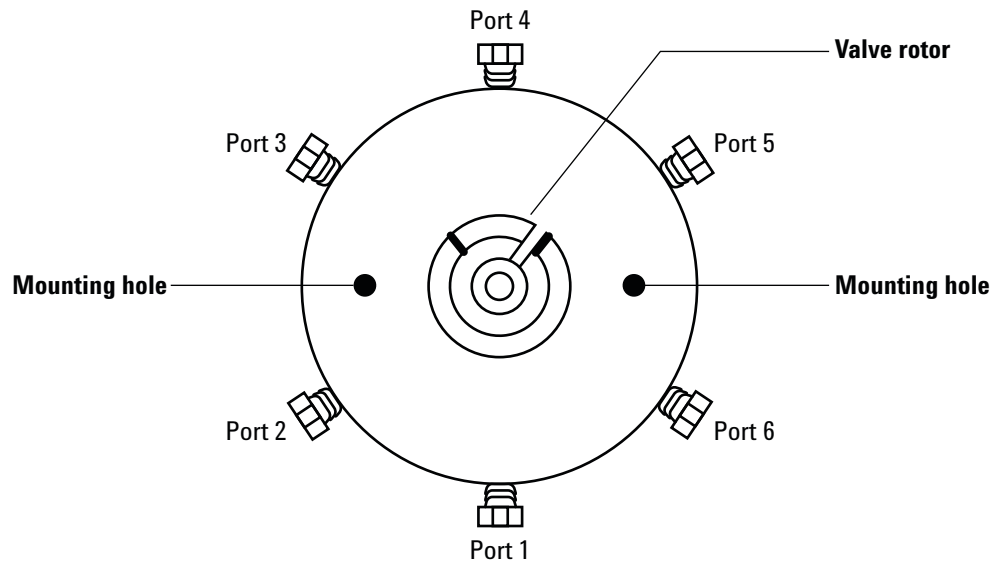
- 8 Using a 1/4-inch wrench, loosen the sample probe connection on the 6 port valve and remove the sample probe fitting from the valve.
- 9 Remove the sample probe.
- 10 Using a 1/4-inch wrench, disconnect the two sample loop ends from the 6 port valve (Figure 27).



**Figure 27** Disconnect the sample loop from the 6 port valve

- 11 Remove the sample loop (Figure 27).
- 12 If necessary, replace the sample loop adapters in the sample loop block and loop cover. See [“To Replace the Sample Loop Adapters”](#) for more information.
- 13 On the new sample loop, check that the nuts on both ends spin freely before installing.

- 14 With the sample loop in front of the 6 port valve, connect both ends of the new sample loop to positions 1 and 4 as shown in Figure 29.

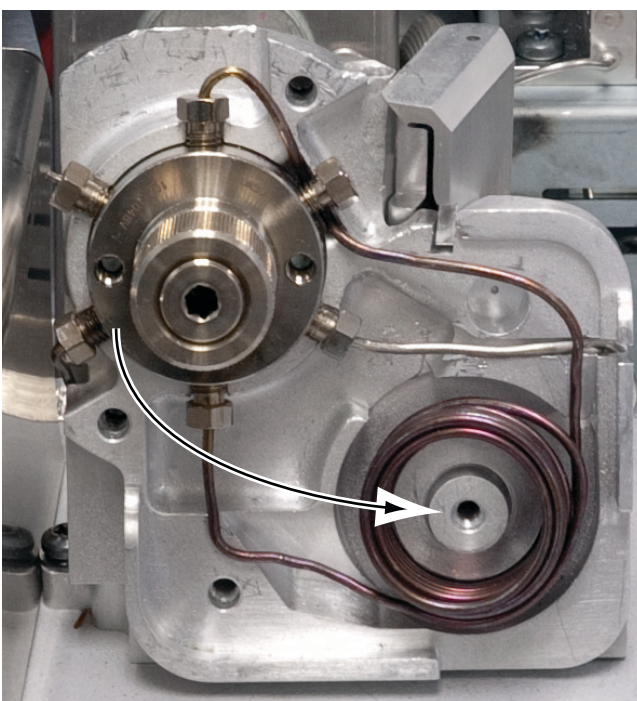


**Figure 28** 6 port valve position numbers

- 15 Finger tighten the nuts. Once both nuts are well-engaged, loosen them by one rotation.



- 16 Rotate the sample loop towards the sample loop block (to the right). Fit the upper end of the sample loop over and behind connection 5 on the valve. Continue rotating the sample loop until it fits into the recessed fitting in the sample loop block as shown in [Figure 29](#).



**Figure 29** Rotate the sample loop into place

- 17 Tighten both nuts securing the sample loop to the 6 port valve about 1/4-turn past finger tight.
- 18 Reinstall the sample probe (see [“To Replace the Sample Probe”](#)), replace all covers, restore all gas flows, and plug in the Headspace power cord.

## To Replace the Sample Loop Adapters

Normally, only change or replace the sample loop adapters when changing sample loop size. A full set of adapters shipped with the Headspace.

### CAUTION

Wear clean, lint-free gloves to prevent contamination of parts with dirt and skin oils.

---

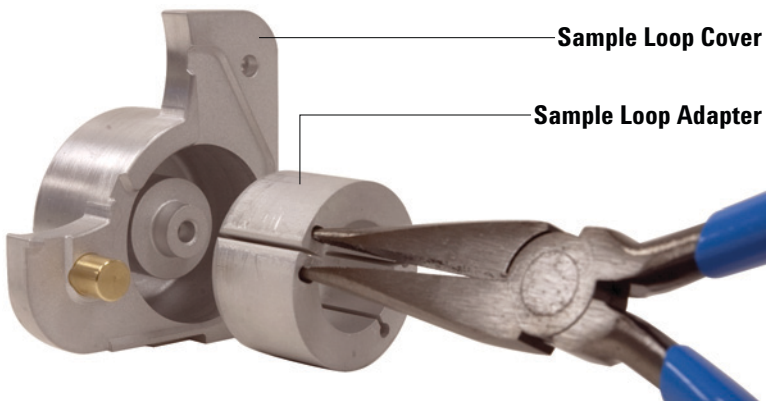
### NOTE

The loop cover is used as an example in this procedure. Steps for the valve/loop cover are similar.

---

- 1 Gather the following:
  - Lint-free gloves
  - Sample loop (see [Table 7](#))
  - Sample loop adapters, as needed (see [Table 2](#))
  - Needle nose pliers
- 2 Depending on your hardware configuration, remove the loop cover or the valve/loop cover, then remove the sample loop. Follow the steps in [“To Replace the Sample Loop”](#).

- 3 Remove any sample loop adapters from the sample loop block and cover.
  - a Grip the sample loop adapter using needle nose pliers in the locations shown in [Figure 30](#).
  - b Squeeze the needle nose pliers together and gently pull the sample loop adapter from the block or cover as shown in [Figure 30](#).



**Figure 30** Removing a sample loop adapter (G4556-20178 shown) from the loop cover (loop cover shown, the valve/loop cover is similar)

- c Repeat as necessary until all sample loop adapters have been removed from both the sample loop block and cover.

- 4 Use [Table 2](#) to select the appropriate adapters for your sample loop size.

**Table 2** Sample loop adapters

Sample loop size	Adapter p/n	Quantity	Installation location
0.025 mL	G4556-20177	1	Sample loop block
	G4556-20178	1	Loop cover
0.050 mL	G4556-20177	1	Sample loop block
	G4556-20178	1	Loop cover
0.10 mL	G4556-20177	1	Sample loop block
	G4556-20178	1	Loop cover
0.50 mL	G4556-20177	2	Loop cover, as needed
1.0 mL	G4556-20177	2	Loop cover, as needed

- 5 Use [Table 2](#) to determine the installation location for each selected adapter (sample loop block or loop cover), and install the adapters. Be sure that the curved side of the adapters face inward on both the sample loop block and cover so that the flat sides are against the sample loop once assembled.
- 6 Install the sample loop and loop cover. Follow the steps in [“To Replace the Sample Loop”](#).

Reassembly is the reverse of these steps.

## To Replace the 6 Port Valve

**CAUTION**

Wear clean, lint-free gloves to prevent contamination of parts with dirt and skin oils.

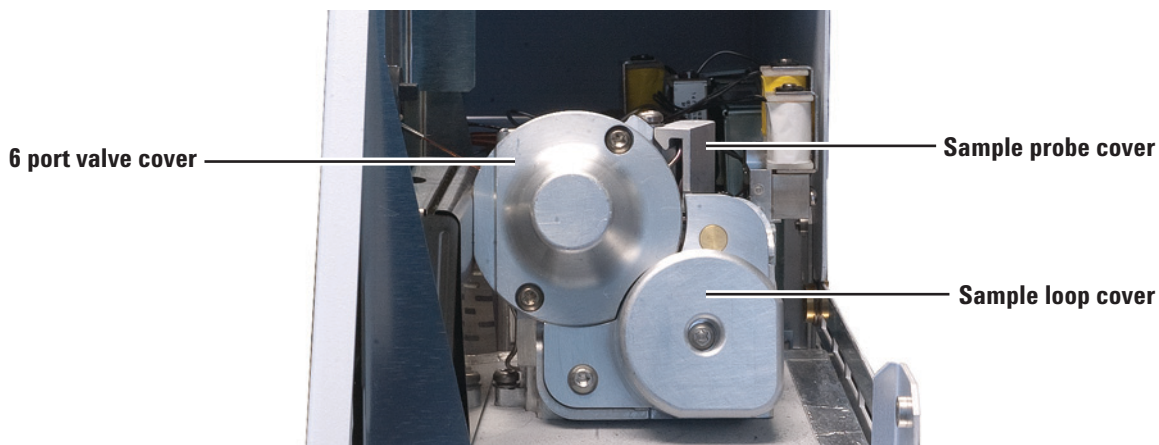
---

- 1 Gather the following:
  - Lint-free gloves
  - 1/4-inch wrench
- 2 Cool your GC oven to ambient temperature.
- 3 Turn the Headspace off and unplug the power cord.
- 4 Wait for the Headspace oven and transfer line to cool before continuing.
- 5 Turn off all gas flows.
- 6 Access the pneumatics area:
  - a Remove the front pneumatics cover. See [“To Remove the Pneumatics Front Cover”](#).
  - b Remove the valve thermal enclosure. See [“To Remove the Valve Thermal Enclosure”](#).
- 7 Depending on your hardware configuration, do one of the following:
  - Remove the loop cover and valve cover. See [“To Remove the Loop Cover”](#) and [“To Remove the Valve Cover”](#).
  - Remove the valve/loop cover. See [“To Remove the Valve/Loop Cover”](#).
- 8 Using a 1/4-inch wrench, remove all connections from the 6 port valve.
- 9 Remove the two T-20 Torx screws on the back of the valve block.
- 10 Lift the 6 port valve out of the pneumatics area.

Reassembly is the reverse of these steps.

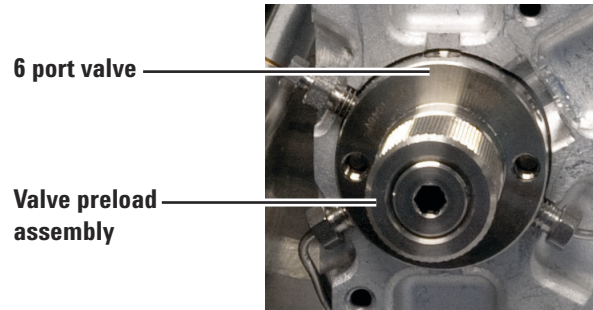
## To Replace the 6 Port Valve Rotor

- 1 Gather the following:
  - Lint-free gloves
  - 1/4-inch wrench
  - Pencil magnet
- 2 Set your GC oven, Headspace oven, and transfer line to ambient temperatures and wait for them to cool.
- 3 Once the GC oven, Headspace oven, and transfer line have cooled to ambient temperature, turn the Headspace off and unplug the power cord.
- 4 Turn all gas flows off at their sources.
- 5 Access the pneumatics area:
  - a Remove the pneumatics front cover. See [“To Remove the Pneumatics Front Cover”](#).
  - b Remove the valve thermal enclosure. See [“To Remove the Valve Thermal Enclosure”](#).
- 6 Depending on your hardware configuration, do one of the following:
  - Remove the loop cover and valve cover ([Figure 31](#)). See [“To Remove the Loop Cover”](#) and [“To Remove the Valve Cover”](#).
  - Remove the valve/loop cover. See [“To Remove the Valve/Loop Cover”](#).



**Figure 31** The valve and loop covers

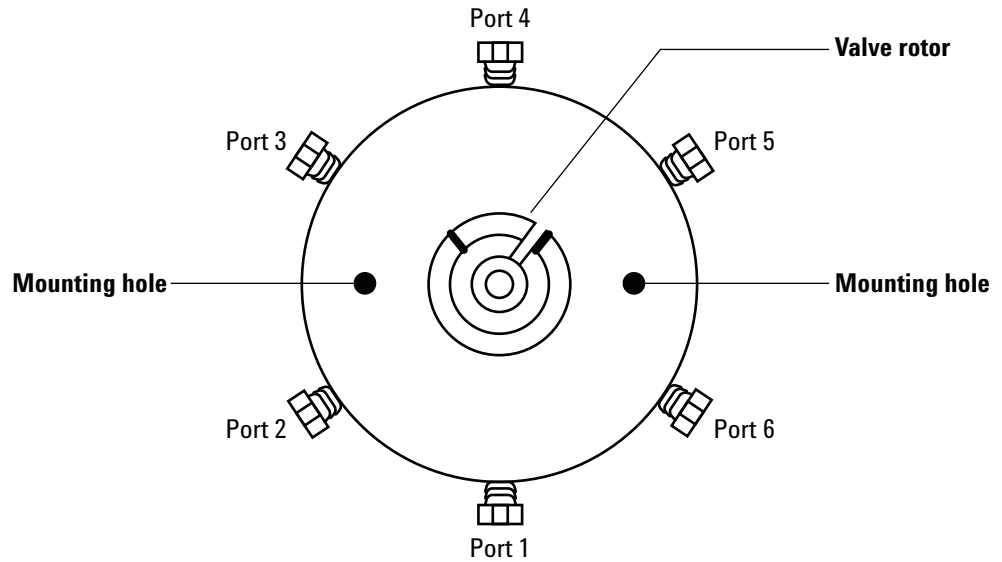
- 7 Unscrew the preload assembly on the front of the valve (Figure 32).



**Figure 32** Valve preload assembly

- 8 Rotate the valve one cycle to break the seal between the rotor and the valve body.
- 9 Carefully remove the rotor from the valve body using a small pencil magnet.

- Using a small pencil magnet, set the new rotor in place on the 6 port valve with the rotor ID letter facing port 4 (Figure 33).



**Figure 33** The 6 port valve and valve rotor

- Completely insert the rotor into the valve body. Make sure the rotor tab does not touch the interior of the valve body.
- Using a small, narrow object such as a pencil, hold the rotor in place while pulling the pencil magnet from the rotor.
- Replace the preload assembly on the front of the valve. Finger-tighten it one turn beyond the point where it first touches the rotor. Cycle the valve 10 times to seat the seal.

Reassemble.



## To Clean the 6 Port Valve and Rotor

**CAUTION**

Wear clean, lint-free gloves to prevent contamination of parts with dirt and skin oils.

---

**CAUTION**

Be careful to not damage the rotor and valve in any way. The rotor must be replaced if any damage is found.

---

- 1 Gather the following:
  - Lint-free gloves
  - Compressed gas
  - Cotton swabs
  - Solvent
  - Needle nose pliers
  - Clean lab tissues
- 2 Remove the rotor from the 6 port valve. Follow the instructions in [“To Replace the 6 Port Valve Rotor”](#) until the rotor is removed.
- 3 Once the rotor is removed, wet a cotton swab with solvent and polish the inside of the valve. Be sure to wipe away any loose residue.
- 4 Use compressed gas to remove any remaining residue.
- 5 Using needle nose pliers, carefully dip the rotor into solvent.
- 6 Wipe the rotor with a clean lab tissue.
- 7 Use compressed gas to blow away any remaining residue.
- 8 Make sure there are no scratches or dents in the interior of the 6 port valve and rotor.
- 9 Reinstall the rotor into the 6 port valve. Follow the instructions in [“To Replace the 6 Port Valve Rotor”](#), starting at [step 10](#).

## To Attach the Transfer Line to a Split Splitless or Multimode Inlet

**CAUTION**

Wear clean, lint-free gloves to prevent contamination of parts with dirt and skin oils.

---

- 1 Gather the following:
  - Lint-free gloves
  - Two 7-mm wrenches
  - Capillary column cutter (5181-8836)
  - Inlet septum, green (5183-4759)

**WARNING**

**Be careful! The oven and/or inlet may be hot enough to cause burns. If either is hot, wear heat-resistant gloves to protect your hands.**

---

- 2 Cool the GC inlet to a safe handling temperature.
- 3 Cool the GC oven to room temperature to prevent column damage. Then turn off the carrier gas.
- 4 Install the transfer line to the 6 port valve. See [“To Install a Fused Silica Column into the Transfer Line”](#).
- 5 Slide the one-piece septum nut and strain relief coupling onto the tubing until the inner metal sleeve of the transfer line bottoms-out on the strain relief.
- 6 Slide the septum onto the tubing until the septum is against the bottom of the one-piece septum nut and strain relief coupling.
- 7 Trim the tubing 35 mm past the end of the septum.
- 8 Install the inlet liner (with o-ring) that is appropriate for your application.
- 9 Insert the tip of the transfer line into the inlet.
- 10 Finger-tighten the strain relief coupling.

- 11 With the transfer line installed, attach the transfer line support bracket.
- 12 Make sure the carrier gas is connected to the GC-MS system in the appropriate configuration. Begin supplying carrier gas to the system. Refer to the [Installation and First Startup](#) manual for more information.
- 13 Heat the split splitless or multimode inlet to operating temperature.
- 14 Retighten the fittings, if necessary.
- 15 Refer to the documentation supplied with your split splitless or multimode inlet for more information.

## To Attach the Transfer Line to a Volatiles Interface

### CAUTION

Wear clean, lint-free gloves to prevent contamination of parts with dirt and skin oils.

#### 1 Gather the following:

- Lint-free gloves
- One 7/16-inch wrench
- Two 5/16-inch wrenches
- Capillary column cutter (5181-8836)
- Appropriate sized SilTite ferrule (for 250-, 320-, or 530- $\mu$ m transfer line diameters)
- Capillary Column Pre-Swaging Tool (G4556-67018)

### WARNING

**Be careful! The oven and/or inlet may be hot enough to cause burns. If either is hot, wear heat-resistant gloves to protect your hands.**

- 2 Cool the GC inlet to a safe handling temperature.
- 3 Cool the GC oven to room temperature to prevent column damage. Then turn off the carrier gas.
- 4 Install the transfer line to the 6 port valve. See [“To Install a Fused Silica Column into the Transfer Line”](#).
- 5 Slide the transfer line nut (G2319-20210) onto the tubing.
- 6 Install a SilTite ferrule and make a SilTite connection as described below. Refer to [Table 3](#) and use the SilTite ferrule appropriate for your transfer line.

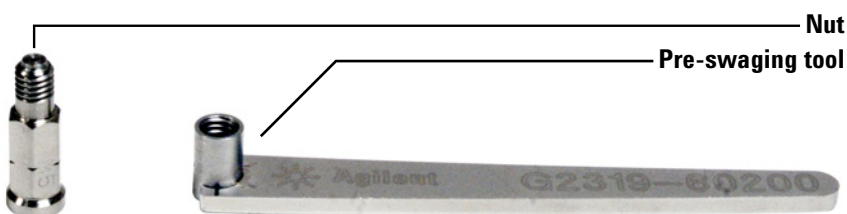
**Table 3** SilTite ferrules

Transfer line id	Use SilTite ferrule part number:
0.25 mm	5188-5361
0.32 mm	5188-5362
0.53 mm	5188-5363

**CAUTION**

The SilTite ferrules are delicate. Follow the instructions in the next steps very carefully to avoid overtightening.

- a Pass the transfer line tubing end through the SilTite ferrule leaving approximately 1 cm of tubing protruding beyond the ferrule. Thread the pre-swaging tool onto the nut (Figure 34) with the tubing protruding through the tool.
- b Using a wrench and ferrule pre-swaging tool tighten the nut a little at a time, occasionally checking to see if the ferrule is gripping the tube. When the ferrule just starts to grip, notice position of the nut and then tighten by turning 45 to 60 degrees of rotation, but no more than 60 degrees (one flat). If you can pull the transfer line tubing free, it is not tight enough.



**Figure 34** Volatiles interface nut and pre-swaging tool (G4556-67018)

- c Remove the pre-swaging tool.
- d Using a ceramic column cutter, trim the tubing at the small end of the ferrule leaving approximately 0.3 mm of tubing extending beyond the ferrule.

It is important that the tube end does not extend beyond 0.5 mm from the end of the ferrule.

- e Check the end of the tube with a magnifier. The end of the tube need not be perfectly square, but should not have cracks which extend under the ferrule.
- 7 Screw the nut onto the volatiles interface.
  - 8 Establish a flow of carrier gas through the transfer line and check for leaks. If the transfer line nut leaks, tighten an additional 1/8 turn with the supplied wrench. Purge as recommended by the column manufacturer.
  - 9 Heat the volatiles interface to operating temperature.
  - 10 Retighten the fittings, if necessary.

- 11** Refer to the documentation supplied with your volatiles interface for more information.

## To Attach the Transfer Line to a Purged Packed Inlet

**CAUTION**

Wear clean, lint-free gloves to prevent contamination of parts with dirt and skin oils.

---

- 1 Gather the following:
  - Two 7-mm wrenches
  - Lint-free gloves
  - Capillary column cutter (5181-8836)
  - Inlet septum, green (5183-4759)

**WARNING**

**Be careful! The oven and/or inlet may be hot enough to cause burns. If either is hot, wear heat-resistant gloves to protect your hands.**

---

- 2 Cool the GC inlet to a safe handling temperature.
- 3 Cool the GC oven to room temperature to prevent column damage. Then turn off the carrier gas.
- 4 Install the transfer line to the 6 port valve. See [“To Install a Fused Silica Column into the Transfer Line”](#).
- 5 Slide the one-piece septum nut and strain relief coupling onto the tubing until the inner metal sleeve of the transfer line bottoms-out on the strain relief.
- 6 Slide the septum onto the tubing until the septum is against the bottom of the one-piece septum nut and strain relief coupling.
- 7 Trim the tubing 2 mm past the end of the septum.
- 8 Install the inlet liner (with o-ring) that is appropriate for your application.
- 9 Insert the tip of the transfer line into the inlet.
- 10 Finger-tighten the strain relief coupling.
- 11 With the transfer line installed, attach the transfer line support bracket.
- 12 Configure the Headspace additive carrier gas flow using the optional G4562A Carrier Gas EPC Module.
- 13 Heat the purged packed inlet to operating temperature.
- 14 Retighten the fittings, if necessary.

- 15** Refer to the documentation supplied with your purged packed inlet for more information.



## To Attach the Transfer Line to a Cool On-Column Inlet

Make sure your column dimensions are correct in relation to the size of your fused silica. Your column id can not be greater than 530 um. Refer to your cool on-column inlet documentation for more information.

### CAUTION

Wear clean, lint-free gloves to prevent contamination of parts with dirt and skin oils.

---

1 Gather the following:

- Lint-free gloves
- Capillary column cutter (5181-8836)

### WARNING

**Be careful! The oven and/or inlet may be hot enough to cause burns. If either is hot, wear heat-resistant gloves to protect your hands.**

---

- 2 Cool the GC inlet to a safe handling temperature.
- 3 Cool the GC oven to room temperature to prevent column damage. Then turn off the carrier gas.
- 4 Install the transfer line to the 6 port valve. See [“To Install a Fused Silica Column into the Transfer Line”](#).
- 5 Trim the fused silica so that it extends 42 mm out of the inner metal sleeve on the transfer line.
- 6 Slide the fused silica through the retaining nut on the cool on-column inlet.
- 7 Finger-tighten the retaining nut. Pull the transfer line gently to be sure the PTFE ferrule has formed a tight seal with the transfer line. Tighten the retaining nut further, if necessary.

- 8 With the transfer line installed, attach the transfer line support bracket.
- 9 Make sure the carrier gas is connected to the GC-MS system in the appropriate configuration. Begin supplying carrier gas to the system. Refer to the [Installation and First Startup](#) manual for more information.
- 10 Heat the cool on-column inlet to operating temperature.
- 11 Retighten the fittings, if necessary.
- 12 Refer to the documentation supplied with your cool on-column inlet for more information.

## To Remove the Fused Silica Column from the Transfer Line

**CAUTION**

Wear clean, lint-free gloves to prevent contamination of parts with dirt and skin oils.

---

- 1 Gather the following:
  - 3/16-inch open end wrench (provided in ship kit)
  - 1/4-inch open end wrench
- 2 Cool down the transfer line and 6 port valve (sample loop) in the headspace sampler.

**CAUTION**

Disconnecting the transfer line may interrupt GC carrier gas flow. Cool the GC column oven and inlet as needed to prevent column damage.

---

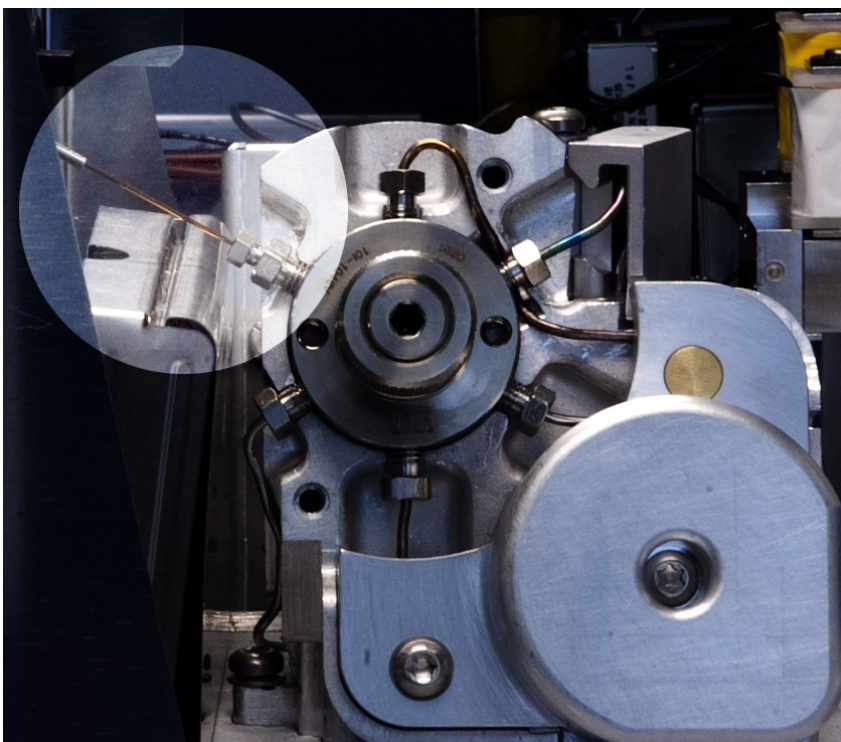
**WARNING**

**Be careful! The oven and/or inlet may be hot enough to cause burns. If either is hot, wear heat-resistant gloves to protect your hands.**

---

- 3 Cool the GC inlet to a safe handling temperature.
- 4 If using GC carrier gas control, or if the Headspace provides the carrier gas flow for the GC, also cool the GC oven to ambient temperature to prevent column damage.
- 5 Remove the pneumatics front cover. See [“To Remove the Pneumatics Front Cover”](#).

- 6** Remove the valve thermal enclosure. See “[To Remove the Valve Thermal Enclosure](#)”.
- 7** Unclamp the transfer line from the support bracket on the GC.
- 8** Remove the GC inlet septum retainer nut. (See the GC maintenance manual for instructions.) Lift the transfer line from the GC.
- 9** Slide the septum retainer nut off of the fused silica column. Gently set aside the transfer line.
- 10** Loosen the 3/16-inch nut in the internal reducer.



- 11** Remove the fused silica column from the internal reducer.
- 12** Carefully straighten the transfer line so there are no sharp curves. This will help from damaging the fused silica and make for easy removal.
- 13** Gently grasp the fused silica tubing at the Headspace end and pull the tubing out of the transfer line.

Save the 3/16-inch nut for future use, if desired.

## To Install a Fused Silica Column into the Transfer Line

**CAUTION**

Wear clean, lint-free gloves to prevent contamination of parts with dirt and skin oils.

---

**CAUTION**

Transfer line bends with a bend radius of less than 75 mm are not recommended. However, if a sharp bend is necessary to route the transfer line, be sure the bend radius is at least 35 mm.

---

- 1 Gather the following:
  - 3/16-inch open end wrench
  - Column cutting wafer
  - 1/4-inch open end wrench
  - Wrench, angled, septum nut (GC inlet wrench)
  - Polyimide ferrule sized for this column (or, use a new 1/16-inch internal reducer union)
  - 530  $\mu\text{m}$ , 250  $\mu\text{m}$ , or 320  $\mu\text{m}$  fused silica column (at least 1.2 m length)
  - 11-mm septum for GC inlet
  - Septum nut adapter (G3452-60835)
  - Isopropanol
  - Lab tissue
  - Lint-free gloves

- 2 Remove the existing fused silica from the transfer line. See [“To Remove the Fused Silica Column from the Transfer Line”](#).

If no fused silica is currently installed, cool the transfer line, 6 port valve (sample loop), and GC inlet and oven to safe handling temperatures.

- 3 Remove the pneumatics front cover. See [“To Remove the Pneumatics Front Cover”](#).

- 4 Remove the valve thermal enclosure. See “To Remove the Valve Thermal Enclosure”.
- 5 The transfer line will install in valve port 3 (at the 10 O’clock position), as shown in Figure 35.

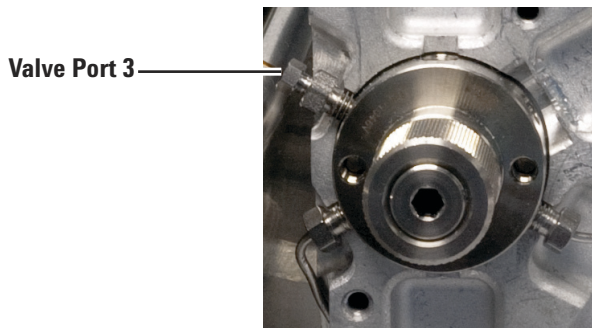


Figure 35 Valve Port 3

The transfer line installs using a 1/16-inch internal reducer, as shown in Figure 36. If possible, leave the existing 1/4-inch nut and ferrule in place and install the new fused silica into it using a new ferrule and the existing 3/16-inch nut.

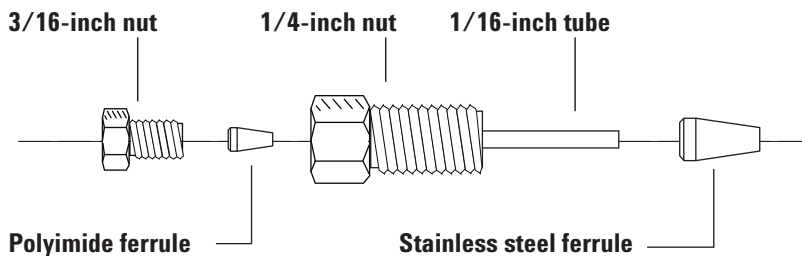


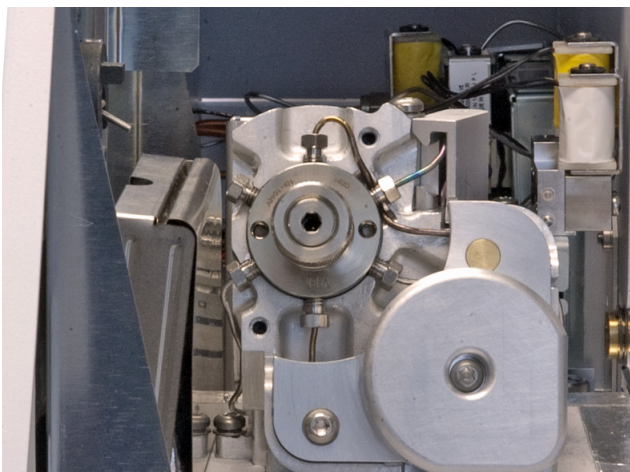
Figure 36 Internal reducer parts

**WARNING**

**Wear safety glasses to protect your eyes from flying particles while handling, cutting, or installing glass or fused silica capillary columns. Use care in handling these columns to prevent puncture wounds.**

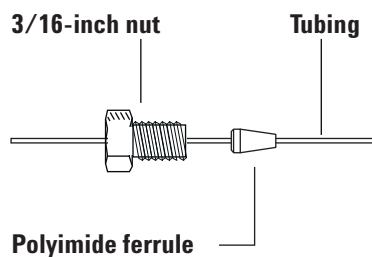
- 6 If using the installed 1/4-inch nut, skip this step.

Slide the stainless steel ferrule over the 1/16-inch tube end of the reducer, then install into the open valve port. Finger-tighten, then tighten 1/4-turn more (Figure 37).

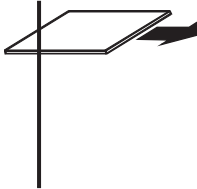


**Figure 37** Installing into the open valve port

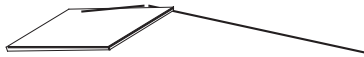
- 7 Uncoil about 1 m of the fused silica tubing. Working from the open end that will connect to the GC (not the end near the 6 port valve), gently slide the tubing through the transfer line until it comes out the end near the 6 port valve.
- 8 Gently grasp the fused silica tubing at the Headspace end and gently push and pull the tubing to verify that it is unbroken in the transfer line. The fused silica should move back and forth.
- 9 Assemble the 3/16-inch nut and polyimide ferrule onto the fused silica tubing as shown below.



- 10** Use a column cutter to trim approximately 1 cm from the leading edge of the fused silica.
- a** Score the column using a glass scribing tool. The score must be square to ensure a clean break.



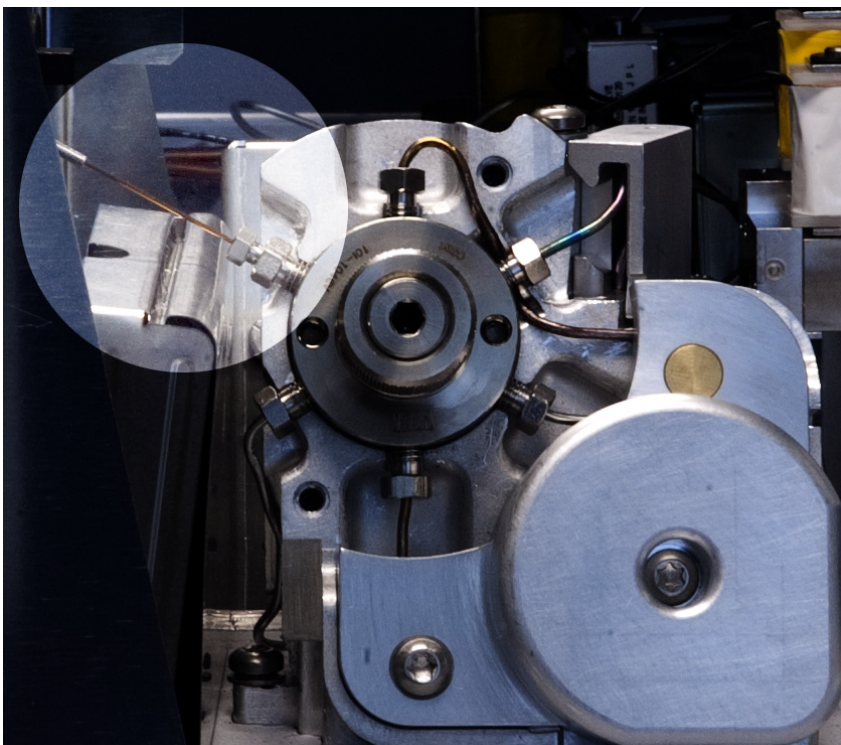
- b** Break off the column end by supporting it against the column cutter opposite the scribe. Inspect the end with a magnifying loupe to make certain there are no burrs or jagged edges.



- c** Wipe the column walls with a tissue dampened with isopropanol to remove fingerprints and dust.
- 11** Loosely install the 3/16-inch nut inside the internal reducer. Do not tighten yet.



- 12 Gently slide the fused silica tubing into the internal reducer until it bottoms. Tighten the 3/16-inch nut finger tight, then an additional 1/4-turn. Test the connection by gently pulling on the transfer line. The transfer line should not slide out of the newly-made fittings. See [Figure 38](#).



**Figure 38** Transfer line installed into 6 port valve

- 13 Attach the other end of the transfer line to the GC inlet.
- To attach the transfer line to a split splitless or multimode inlet, see [“To Attach the Transfer Line to a Split Splitless or Multimode Inlet”](#).
  - To attach the transfer line to a volatiles interface, see [“To Attach the Transfer Line to a Volatiles Interface”](#).
  - To attach the transfer line to a purged packed inlet, see [“To Attach the Transfer Line to a Purged Packed Inlet”](#).
  - To attach the transfer line to a cool on-column inlet, see [“To Attach the Transfer Line to a Cool On-Column Inlet”](#).

## To Use ProSteel Tubing

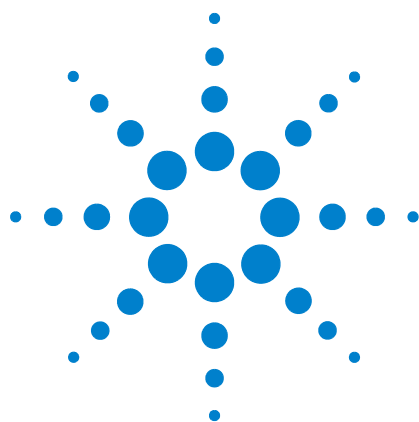
If you wish to use ProSteel tubing in place of fused silica in the transfer line, the installation and removal procedures for ProSteel tubing are similar to the fused silica procedures except for the following steps:

- 1 Cut a ProSteel metal capillary (0.53 mm ID with maximum OD of 0.67 mm) to approximately 1 m in length using a precision tubing cutter.
- 2 If you intend to operate at temperatures 200 °C and higher, you must use the ProSteel protective sleeve with ProSteel tubing. Without the ProSteel protective sleeve, the ProSteel tubing can permanently bind to the heated conduit tube.

To install the ProSteel protective sleeve:

- a Trim the ProSteel protective sleeve to match the length of the transfer line (approximately 1 m), plus or minus a few millimeters.
  - b Straighten the ProSteel tubing and protective sleeve.
  - c Slide the ProSteel tubing into the protective sleeve.
- 3 Follow the procedure for installing the fused silica into the transfer line. See [“To Install a Fused Silica Column into the Transfer Line”](#).
    - Make sure the ProSteel protective sleeve protrudes a few millimeters from both ends of the transfer line for easy removal.
    - Be sure to use the appropriate ferrule and nut supplied with your ProSteel metal capillary.

See [“To Remove the Fused Silica Column from the Transfer Line”](#) for removal instructions.



## 4 Consumables and Parts

Consumables and Parts for the Agilent 7697A Headspace Sampler 68

This section lists the consumables and parts for the Agilent 7697A Headspace Sampler.

## Consumables and Parts for the Agilent 7697A Headspace Sampler

See the Agilent catalog for consumables and supplies for a more complete listing, or visit the Agilent Web site for the latest information ([www.agilent.com/chem/supplies](http://www.agilent.com/chem/supplies)).

**Table 4** Headspace sampler parts and standards

Description	Part number
Leak test kit. Includes:	G4556-67010
• No hole ferrule	5181-7458
• 11 mm low bleed septa, 5/pk	5182-3413
• Headspace (blue) leak test vial	G4556-20600
• 1/8-in. nylon tube fitting plug	0100-2414
• 1/16-in. stainless steel ZDV plug (6 port valve cap)	G6600-80039
Tray vial rack set, 7697A (3 racks)	G4564A
Tray vial rack	G4556-60019
Tray vial rack labels	G4556-90500
Universal/external split vent trap with 3 cartridges, 1/8-inch Swagelok fitting	RDT-1020
Column cutting wafer, ceramic	5181-8836
Sample probe, deactivated SN1030	G4556-60690
Sample probe, deactivated SN2000	G4556-60125
6-port valve, replacement rotor, WT series, 300 psi, 350 °C	1535-4952
Sample loop adapter:	G4556-20177
1 ea. used with 0.025, 0.05, and 0.10 mL sample loops	
2 ea. used with 0.5 and 1.0 mL sample loops	
Sample loop adapter:	G4556-20178
1 ea. used with 0.025, 0.05, and 0.10 mL sample loops	
<b>Standards</b>	
GC headspace evaluation standard, 1 x 1 mL	8500-4328
Headspace OQ/PV sample	5182-9733

**Table 5** Headspace vials and caps

Description	Part number
<b>Certified flat bottom vials</b>	
Certified flat bottom headspace vials, 20 mL, 100/pk	5182-0837

**Table 5** Headspace vials and caps (continued)

Description	Part number
Certified flat bottom headspace vials, 10 mL, 100/pk	5182-0838
<b>20 mm Headspace caps, with septa</b>	
Certified headspace Al crimp cap, PTFE/Si septum, 20 mm, 100/pk	5183-4477
<b>Headspace vial kits</b>	
Vial kit 20 mL Headspace crimp top, flat bottom vials, silver aluminum one-piece crimp caps with safety feature, PTFE/white silicone septa, 100/pk	5182-0840
<b>Cappers and decappers</b>	
Electronic crimper for 20 mm cap vials	5062-0208
Electronic decapper, for 20 mm crimp caps	5062-0210
Ergonomic manual crimper for 20 mm caps	5040-4669
Ergonomic manual decapper for 20 mm caps	5040-4671

**Table 6** Headspace sampler transfer line parts

Description	Part number
<b>Transfer line components</b>	
Ferrule, polyimide Valcon, 5/pk	
0.53 mm, 1/32 in. for tubing OD $0.50 \leq 0.80$ mm	0100-2595
0.25, 0.32 mm, 1/32 in. for tubing OD $0.25 \leq 0.40$ mm	5190-1437
Septum nut, transfer line, for split/splitless and multimode inlets	G3452-60835
Blanking nut, 1/16-inch stainless steel	01080-83202
Nut and reducing union for 6 port valve and transfer line connection	0100-2594
<b>Transfer lines</b>	
Deactivated fused silica, 250 $\mu$ m x 5 m	160-2255-5
Deactivated fused silica, 320 $\mu$ m x 5 m	160-2325-5
Deactivated fused silica, 450 $\mu$ m x 5 m	160-2455-5
Deactivated fused silica, 530 $\mu$ m x 5 m	160-2535-5

**Table 6** Headspace sampler transfer line parts (continued)

Description	Part number
ProSteel deactivated stainless steel, 5 m length	160-4535-5
ProSteel sleeve for ProSteel, 5 m length	4177-0607

**Table 7** Headspace sampler sample loops

Description	Part number
<b>Sample loops, SN 2000</b>	
0.025 mL	G4556-80101
0.05 mL	G4556-80102
0.1 mL	G4556-80103
0.5 mL	G4556-80105
1.0 mL	G4556-80106
1.0 mL, Certified	G4556-80126
3.0 mL	G4556-80108
3.0 mL, Certified	G4556-80128
5.0 mL	G4556-80109
<b>Sample loops, SN 1030</b>	
0.025 mL	G4556-80111
0.05 mL	G4556-80112
0.1 mL	G4556-80113
0.5 mL	G4556-80115
1 mL	G4556-80116
3 mL	G4556-80118
5 mL	G4556-80119
<b>Adapters for sample loops</b>	
Sample loop adapter: 1 ea. used with 0.025, 0.05, and 0.10 mL sample loops 2 ea. used with 0.5 and 1.0 mL sample loops	G4556-20177
Sample loop adapter: 1 ea. used with 0.025, 0.05, and 0.10 mL sample loops	G4556-20178



