



Agilent 7890B Gas Chromatograph

**RESOLVE
YOUR SEARCH
FOR RELIABILITY**

The Measure of Confidence



Agilent Technologies

Resolve your search for the next evolution in gas chromatography

The NEW Agilent 7890B GC

Building the world's most trusted GC system is an ongoing process. With every step, we increase speed, improve functionality, and incorporate new analytical capabilities – all while never losing sight of the most important objective: *results*.

Now, Agilent has achieved a new level of GC performance and GC/MSD system integration

Agilent's flagship 7890B GC system has everything you need to boost productivity, protect our environment through better resource management, and generate data with confidence. In addition, its seamless communication with the Agilent 5977A Series GC/MSD provides faster vent times and system protections when using hydrogen carrier gas.



The Agilent 7890B GC adds integrated "smart" functionality and improved performance to the industry-leading GC platform.

Leading-edge technologies increase analytical capabilities and reliability

Proven reliability meets improved performance

Agilent's 5th-generation electronic pneumatics control (EPC) and digital electronics are now complemented by improved detector specifications, making the 7890B Agilent's most dependable – and highest-performing GC – ever.

Higher sample throughput

Fast oven cool-down, new backflush capabilities, and advanced automation features help you get more done in less time, at the lowest possible cost per sample. All can easily be incorporated into your existing method.

NEW integrated intelligence

Early maintenance feedback lets you replace parts quickly, and address small problems *before* they lead to costly downtime. Built-in calculators and method translator are also integrated into the data system software to simplify method setup and system operation.

What's more, the improved GC↔MSD communication cuts venting time by up to 40%, and protects the system from damage by stopping the flow of carrier gas during shutdown events.

Expanded chromatographic capabilities

A flexible EPC design enables sophisticated analyses, while an optional 3rd detector (TCD or ECD) lets you run multiple analyses on a single GC.



Eco-friendly operation

Sleep mode reduces power and gas consumption during periods of inactivity, while **Wake mode** readies the system for high-throughput operation. You can also switch to lower-cost gases while in standby mode. **Page 12**



Faster, more intuitive software

New Agilent OpenLAB CDS is 40 times faster. Tools and wizards have also been added to help you turn results into answers, faster. **Page 10**



End-to-end protection for active compounds

Agilent now applies our proprietary deactivation technologies to our new Split/Splitless inlet option, Ultra Inert liners, gold seals, columns, and improved detectors. So you can be sure you're getting an inert flow path from injection to detection. **Page 9**



Enhanced inlet and detector modules

Numerous module enhancements let you customize your GC system in minutes to suit your changing application needs. **Page 8**



New integrated system maintenance and Parts Finder tools

Reduce downtime and operating costs with simplified maintenance and status monitoring. Find consumables and replacement parts faster with a 3D graphical tool. **Page 12**



Enhanced Capillary Flow Technology (CFT)

CFT modules enable leak-free, in-oven connections while improving throughput and reliability. An easy setup wizard gets you up and running quickly. **Page 6**



Wide choice of system components

Configure and automate your system to increase efficiency and productivity – and expand your analytical capabilities. **Page 14, 21**



Reduce dependency on helium

Integrated calculators help you convert helium methods to more available – and less expensive – gases like hydrogen or nitrogen. **Page 12**

Advanced capabilities help you get the job done, faster



Agilent's 7890B GC builds on a 45-year tradition of leadership and innovation, providing everything you need to take your lab to the next level of GC and GC/MS productivity, performance, and resource management.

The heart of performance

Precise pneumatics and oven temperature control, combined with Agilent J&W Ultra Inert GC columns, give you outstanding resolution and retention time repeatability – the basis for all chromatographic measurement.

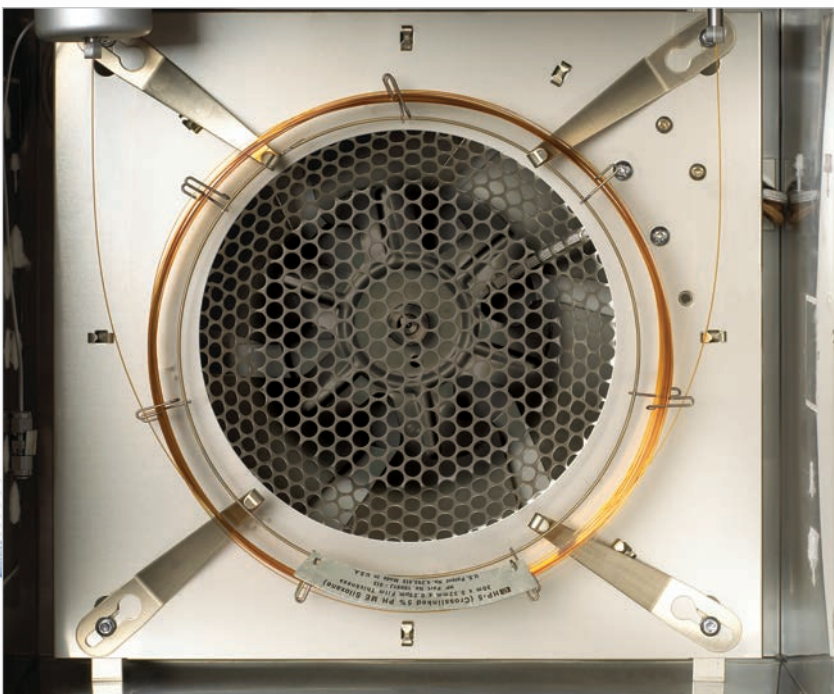

The heart of reliability

No other manufacturer has Agilent's depth of experience in electronic flow control. Our pneumatics manifold reduces the need for parts and seals, improving gas flow precision and stability. Integrated electronics and advanced mechanical design further enhance dependability and versatility.



Precise Retention Time Locking (RTL) software

RTL reproduces retention times from one Agilent GC system to another – regardless of inlet, detector, operator, or location. So you can confidently transfer methods worldwide.

Agilent's 5th generation EPC and digital electronics further improve RTL precision for low-pressure applications (to 0.001 psi actual).

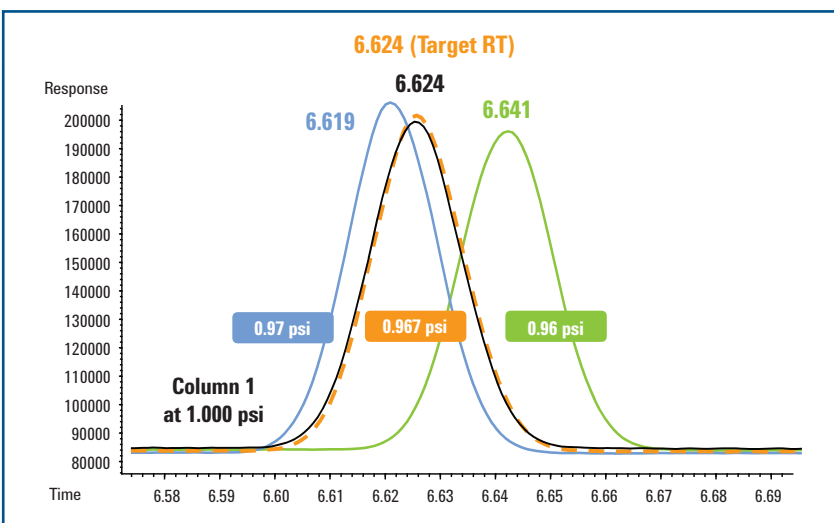

5989-8366EN: Low Pressure Retention Time Locking with the 7890 GC

Unsurpassed retention time reproducibility

5th-generation electronic pneumatics control (EPC) makes it easy to set pressure and flow – and to *keep* these setpoints consistent from run to run for retention time repeatability.

| Run | Peak 1* | Peak 2* |
|--------------------|------------|-------------|
| 1 | 9.0839 min | 11.8492 min |
| 2 | 9.0835 | 11.8492 |
| 3 | 9.0841 | 11.8494 |
| 4 | 9.0846 | 11.8496 |
| 5 | 9.0851 | 11.8507 |
| 6 | 9.0849 | 11.8502 |
| 7 | 9.0845 | 11.8504 |
| 8 | 9.0849 | 11.8500 |
| 9 | 9.0847 | 11.8504 |
| 10 | 9.0853 | 11.8502 |
| 11 | 9.0852 | 11.8502 |
| 12 | 9.0851 | 11.8508 |
| 13 | 9.0847 | 11.8503 |
| 14 | 9.0848 | 11.8507 |
| 15 | 9.0853 | 11.8506 |
| Average | 9.0847 min | 11.8501 min |
| Standard Deviation | 0.000527 | 0.000535 |

*Heart-cut from column 1.

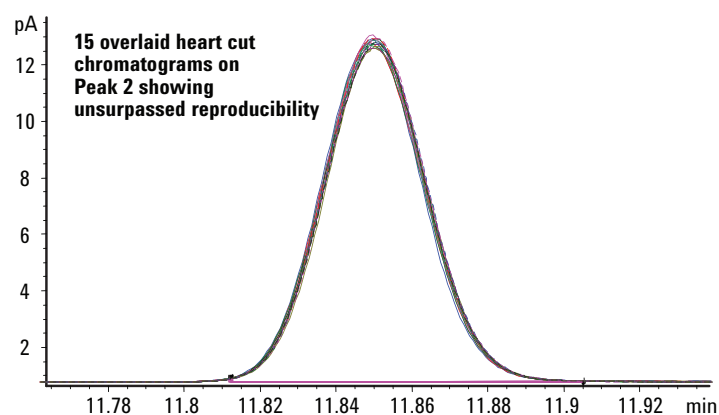

Achieve unsurpassed retention time reproducibility in standard applications – even with multi-dimensional applications, such as the heart-cutting example shown here.

To learn more about the Agilent 7890B GC, visit www.agilent.com/chem/7890B

Add dimension to your chromatography with Capillary Flow Technology

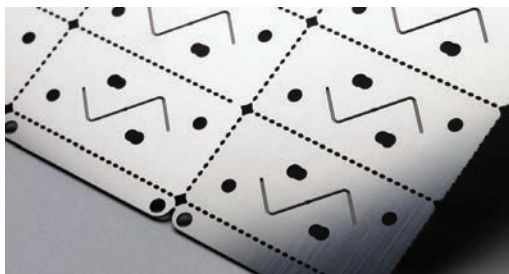

Agilent's proprietary Capillary Flow Technology (CFT) solves a problem chromatographers have been wrestling with for decades: creating leak-free capillary connections that can withstand the temperature extremes of a modern GC oven.

CFT devices are inert, with low mass and low dead volume to help you make secure connections and precisely divert your gas flow

pneumatically. This opens the door to techniques that can expand analytical capabilities, improve your results, and conserve both time and resources.

CFT backflush saves you time with every run

Backflushing works by reversing the column flow immediately after the last compound of interest has eluted, thereby sweeping material backwards through the column and out the split vent.

This simple technique extends column life and eliminates long bake-out times for highly retained sample components. It also prevents problems such as carryover, retention time shifts, and MSD source contamination.

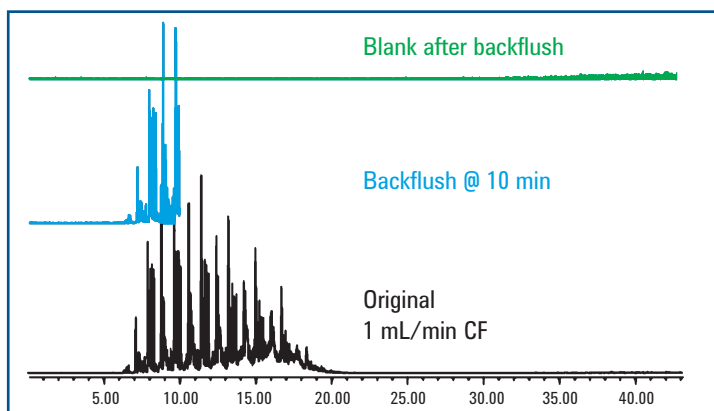

5989-9804EN: Capillary Flow Technology: Backflush – Reduce Run Time and Increase Laboratory Throughput

Backflush Assistant Software Wizard guides you to greater productivity

The Backflush Assistant Software Wizard first collects information about your method and CFT device, then provides a step-by-step procedure for configuring the backflush hardware and column plumbing. Once the backflush-enabled method and timing are determined, a validation protocol confirms that the method performs properly and robustly.

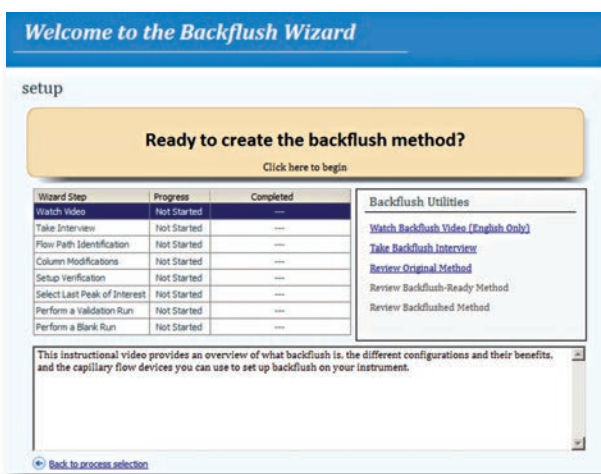

5991-1114EN: Capillary Flow Technology: Purged Ultimate Union – Reduce Downtime and Increase Your Lab's Productivity

Expert training: just a phone call away

Backflush and Backflush Assistant Software Wizard training from Agilent Workflow Services can help you set up your CFT Backflush method quickly and efficiently.

Capillary Flow Technology Deans Switch and flow splitters enhance chromatographic capabilities

Valve components have been used for decades to perform GC heart cutting between two columns. However, a Capillary Flow Technology (CFT) Deans Switch, using fluidic switching, allows precise, 2-dimensional GC heart-cutting analysis of trace compounds in complex matrices.

How a Deans Switch improves selectivity for trace compounds in complex matrices

Peaks of interest from one column are "cut" onto a second column with a different stationary phase. Compounds that might co-elute with analyte on the first column are separated from analyte on the second column. In this way, selectivity is improved for trace compounds in complex matrices.

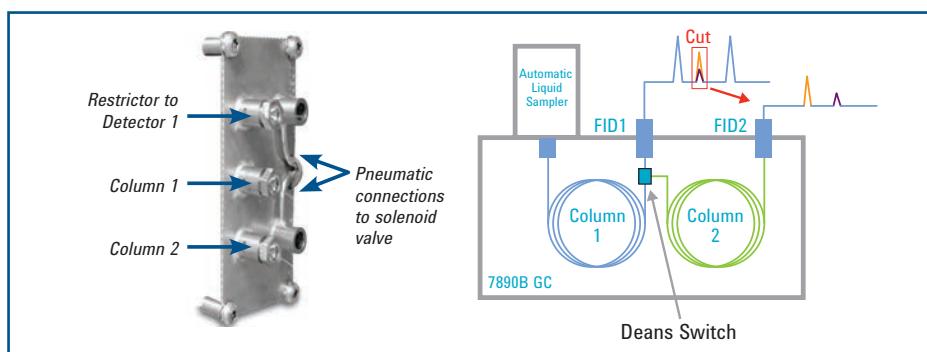

In this example, the Capillary Flow Deans Switch enabled unresolved trace components to be heart-cut onto a second column with a different stationary phase.

5989-9384EN: Capillary Flow Technology: Deans Switch – Increase the Resolving Power of Your GC

Flow splitting can help you pull the most data from your samples

Flow splitting – sending the sample to multiple detectors – maximizes the data collected in a single run, and is especially valuable for analyzing compounds in complex matrices. This technique can also help you identify peaks of interest more quickly, improve peak integration, and identify unknowns with greater confidence.

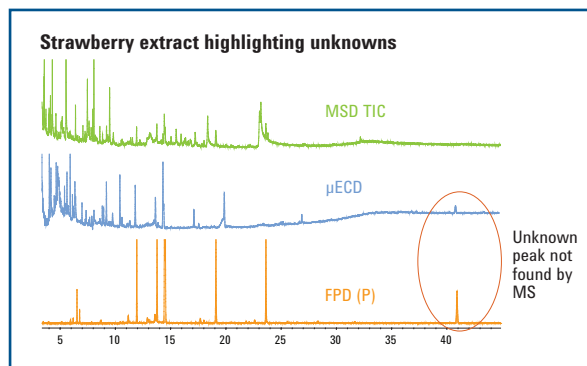

TIP: Agilent UltiMetal Plus Flexible Metal ferrules improve the reliability of your GC column connections. Learn more at www.agilent.com/chem/flexiferrule

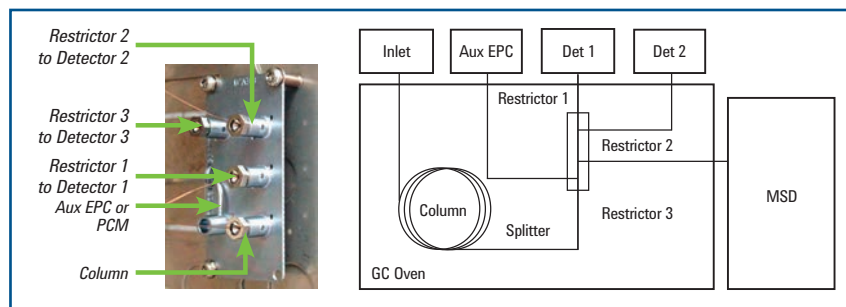

Agilent CFT devices provide easy-to-make, low-volume, connections for better chromatography.

5989-9667EN: Capillary Flow Technology: Splitters – Get More Information in Less Time

To learn more about the Agilent 7890B GC, visit www.agilent.com/chem/7890B

Keep your lab running at peak performance — now, and in the future

The modular Agilent 7890B GC system lets you choose from the industry's widest selection of inlets, detectors, columns, and automated sample introduction techniques. Entire injector and detector modules can be changed in minutes, while injector and detector components can be swapped independently of pneumatics and electronics — saving your lab money.

Versatile Multimode Inlet (MMI)

Agilent's MMI combines spit/splitless operation (cold, hot, and pulsed), temperature programming, and large-volume injection with a solvent vent mode. Benefits include higher system sensitivity, robust handling of dirty samples, and the ability to analyze thermally labile compounds.

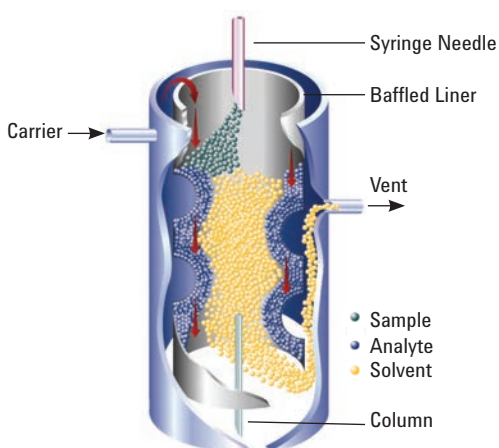

5990-3954EN: Agilent Multimode Inlet for Gas Chromatography

Full dynamic range FID

Our state-of-the-art digital electrometer delivers a linear dynamic range of 10^7 , seamlessly integrated into a single run.

Sensitive and selective element detection

Agilent offers several element-selective detectors, including our new Flame Photometric Detector (FPD) with improved sensitivity and a temperature range up to 400 °C. For demanding applications, Sulfur Chemiluminescence Detectors (SCD) and Nitrogen Chemiluminescence Detectors (NCD) provide the highest sensitivity and selectivity.

5990-3237EN: Dual Channel Simulated Distillation of Carbon and Sulfur with the Agilent 7890A GC and 355 Sulfur Chemiluminescence Detector

Low Thermal Mass (LTM) technology for faster cycle times

LTM technology for GC and GC/MS promotes direct, rapid heating and cooling for faster GC analyses and higher sample throughput. With its independent temperature control of up to four column modules, LTM technology also enables multidimensional GC and integration with Capillary Flow Technology for reduced column maintenance.

Note, too, that LTM systems consume far less power than a conventional GC platform. To simplify method transfer, most Agilent J&W GC columns are available for LTM modules.

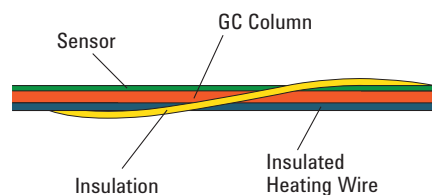

The key to LTM technology: weaving direct heating and temperature-sensing components around a standard fused-silica capillary column (up to 30 meters) for rapid heating and cooling.

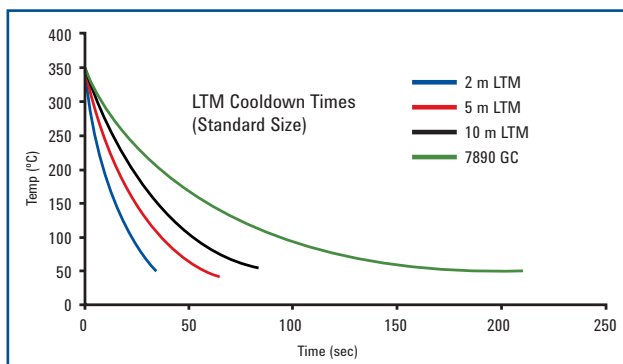

Typical cooling times for standard (5-inch) LTM column modules are significantly faster than a conventional GC oven.

5990-7688EN: Agilent Low Thermal Mass (LTM) Series II System for Gas Chromatography

Ensuring an inert flow path has never been more critical



As samples become smaller, increasingly active, and more complex, you simply cannot afford losses caused by flow path activity.

For starters, having to repeat or verify suspect analyses wastes valuable resources, hinders productivity, and hurts your bottom line. And with trace amounts of active analytes, you might not even get a second chance, because there may be no more sample left to analyze.

Agilent's Inert Flow Path Split/Splitless inlet option ensures the inertness of flow path surfaces, allowing analytes to safely pass from injector to detector.

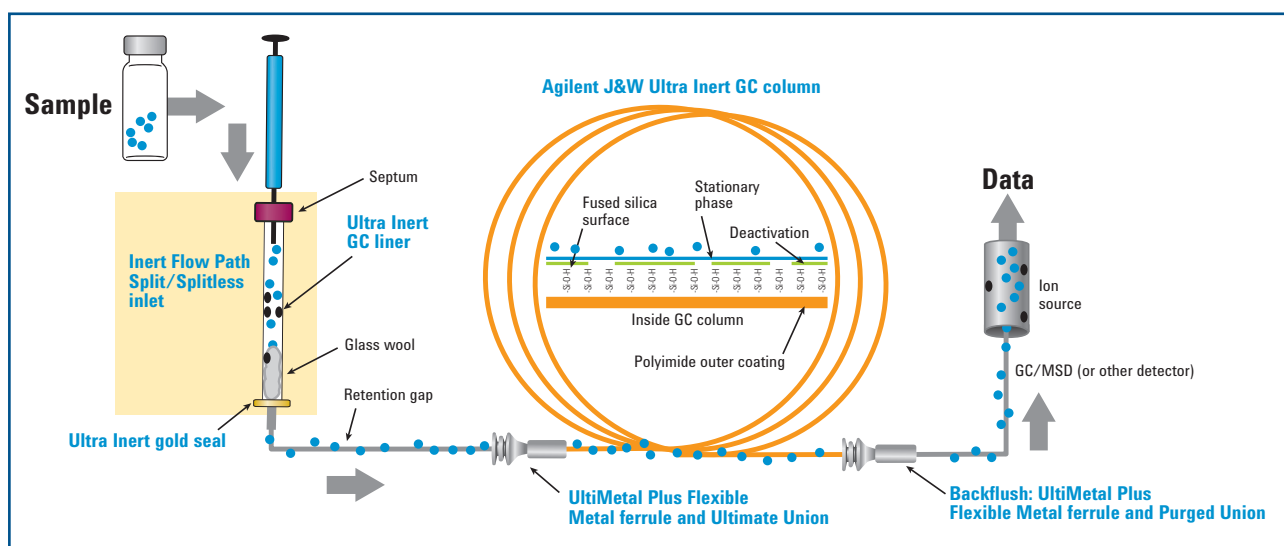

An integrated approach to inertness: The Agilent advantage

As the GC industry's premier measurement company, Agilent is uniquely positioned to help ensure the inertness of every surface that touches your sample, so you can achieve the parts-per-billion – or parts-per trillion – detection levels that today's analyses demand.

- **Agilent J&W Ultra Inert GC columns** are tested with the industry's toughest test probe mixture to ensure consistent column inertness and exceptionally low column bleed.
- **Ultra Inert liners** deliver a robust, reproducible and reliable inert flow path – with or without glass wool.
- **Inert Flow Path Split/Splitless inlet option** provides an extra measure of inertness to the sample pathway.
- **Ultra Inert gold seals** feature deactivation chemistry applied *on top* of their gold plating for the most inert surface and highest-quality seal.
- **UltiMetal Plus Flexible Metal ferrules** are compatible with Capillary Flow Technology fittings, promoting a leak-free seal that requires less torque – and reduces the risk of column breakage.
- **Gas Clean filter systems** deliver the cleanest possible gas, reducing column damage, sensitivity loss, and downtime.
- **GC detectors** allow the selectivity or sensitivity that your application requires – and the ability to handle your data with a unified platform.

For more information about creating an inert GC flow path, visit www.agilent.com/chem/inert

Intuitive software tools simplify operations and boost productivity for every user

Integrated method development tools and calculators take the guesswork out of tasks such as changing carrier gas, selecting the right liner, or changing to a column of different dimensions.

Interactive graphical consumables and parts identification tool quickly locates key parts on the GC system, and provides part numbers and descriptions for easy ordering.

Consumables database simplifies method development by minimizing tracking errors and automatically populating analytical methods with key configuration information.

Resource conservation tools, such as automatic sleep and wake modes, reduce gas and power consumption, while making sure the system is ready to run when you need it.

GC/MS MassHunter with MSD ChemStation Data Analysis: Agilent's newest platform designed to resolve your search for data



Quickly and confidently find the answers you seek for routine quantitation and more challenging discovery applications.

Choose either MassHunter or MSD ChemStation Data Analysis – the traditional choice for GC/MS analysis.

Common instrument control for Agilent GC/MS systems simplify your laboratory operation.



Agilent's Barcode Printing Bundle (G9201AA) has everything you need to print labels for the 7693 ALS and 7697A Headspace Samplers.



OpenLAB

CAPTURE • ANALYZE • SHARE

OpenLAB CDS resolves your search for speed with updated data analysis and reporting

OpenLAB CDS is available in **ChemStation** and **EZChrom Editions**. Both retain their familiar look and feel, but with significant improvements that will make your work routine more efficient. These include:

- Easy, intuitive custom reporting with new OpenLAB Intelligent Reporting – featuring graphical “drag and drop” capability
- Powerful data analysis speeds up results review and enables you to process large data sets faster
- Optimized control, data acquisition, and data processing for your Agilent 7890B GC
- Better management of user privileges and password protection

Centralized data storage is also available through Agilent OpenLAB Data Store and OpenLAB ECM software.

Flexible architecture expands from a single instrument to lab-wide implementation.

Advanced data analysis and reporting drives greater throughput and productivity.

A trusted upgrade path preserves your investment in workflows, data, and methods.

Networked OpenLAB CDS allows you to get your work done from anywhere in the lab – and simplifies the administration of methods, user roles, and permissions.



To learn more about the Agilent 7890B GC, visit www.agilent.com/chem/7890B

Resolve your search for integration

Smart features take supportability, performance, and safety to new heights

Integrated GC ↔ MSD communication and safety controls

Direct communication between the 7890B GC and 5977A Series GC/MSD enhances and protects your investment:

- ▶ If the MSD vents... the system increases the flow of carrier gas, shortening vent times by up to 40%
- ▶ If the pump fails... the system shuts off the carrier gas, saving expensive helium or avoiding hydrogen build-up
- ▶ If communications are lost... the system shuts down the GC thermal zones

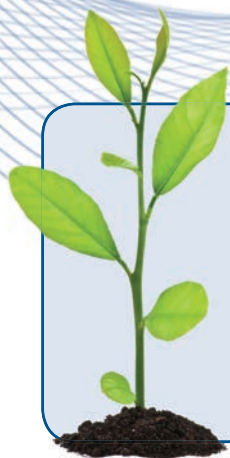

Eco-friendly

- ▶ Can also be used with hydrogen or nitrogen carrier gas to reduce operating costs
- ▶ Sleep/wake modes reduce gas and energy consumption

Parts information at your fingertips

- ▶ Easily locate part numbers for consumables and supplies with Parts Finder, an interactive 3D graphical tool
- ▶ Instantly see parts and consumables specific to *your* instrument configuration. You can then print or email purchase orders, or import directly into your Agilent.com cart
- ▶ Keep track of columns and supplies with an optional barcode reader, and auto-import accurate configuration information into your GC and analytical method
- ▶ Parts ID tool quickly identifies parts and part numbers for easy re-ordering



Optimize productivity

- ▶ Early-maintenance feedback allows you to plan routine maintenance tasks and reduce unnecessary downtime
- ▶ Agilent Data Systems easily develop and optimize methods through:
 - Integrated GC Calculators, including method translator and vapor volume calculator
 - Auto transfer of calculated values to the method editor
 - Setup and status of maintenance tracking counters

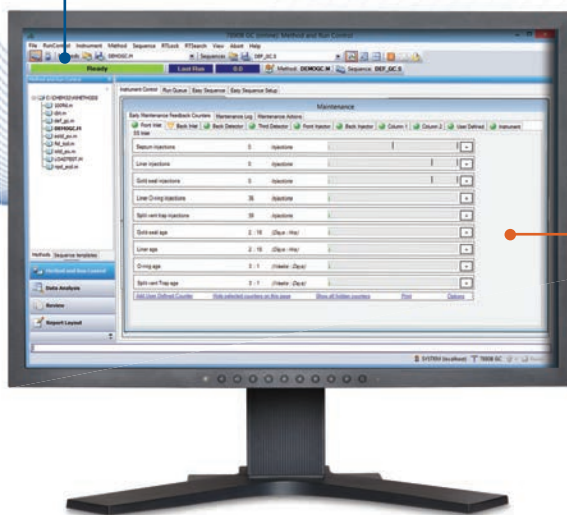

To learn more about the Agilent 7890B GC, visit www.agilent.com/chem/7890B

Agilent autosamplers: the perfect partners for your 7890B GC



With its 16-vial capacity and dual simultaneous injection, the Agilent 7693 Series Automatic Liquid Sampler (ALS) delivers the fastest injection times of any GC autosampler. For large-capacity labs, the 7693A platform offers a 16- or 150-vial capacity. Enhanced capabilities – such as automated dilution, internal standard addition, heating, mixing, and solvent addition – help eliminate variability and rework.

If your lab processes fewer than 50 samples per day, the Agilent 7650A ALS is a robust, lower-cost option for optimizing workflows and maximizing sample throughput.

Boost your lab's output with advanced sample preparation capabilities

The Agilent PAL Autosampler is ideal for liquid injection, headspace, and solid-phase microextraction (SPME) applications. Although this versatile platform can be configured solely for liquid injection, it also offers many capabilities – including large-volume injection (LVI), multiple vial sizes, and extended sample vial capacity.



Automatically introduce volatile compounds from virtually any sample matrix

Agilent's 7697A Headspace Sampler ensures an inert sample pathway for superior GC system performance without analyte degradation or loss. Electronic Pneumatics Control (EPC), a 111-vial capacity, and three exchangeable 36-vial racks make the 7697A an ideal choice for high-throughput labs. In addition, the Agilent 7697A Headspace Sampler is the industry's only dedicated headspace unit that supports the use of hydrogen as a carrier gas.



Protect your instrument – and the integrity of your samples – with Agilent's industry-leading vials, caps, and syringes

✓ Optimize your productivity ✓ Extend the life of your system ✓ Maximize your uptime



View the Agilent Sample Introduction brochure at www.agilent.com/chem/library and search for 5991-1287EN.

Confidently detect impurities at very low levels

Gas chromatography, coupled with static headspace sampling, is an easy-to-use, high-throughput tool for determining residual solvent impurities in pharmaceutical products. Sample preparation is relatively simple, and the method is easily validated. In addition, headspace sampling allows you to avoid large-water injections that can cause column degradation and coelution.

Residual solvent analysis using an Agilent 7890B GC system with an Agilent 7697A Headspace Sampler

Excellent chromatographic performance was achieved for residual solvents at USP <467> specified limits, as shown in this example for Procedure A - Class 1 Solvents.

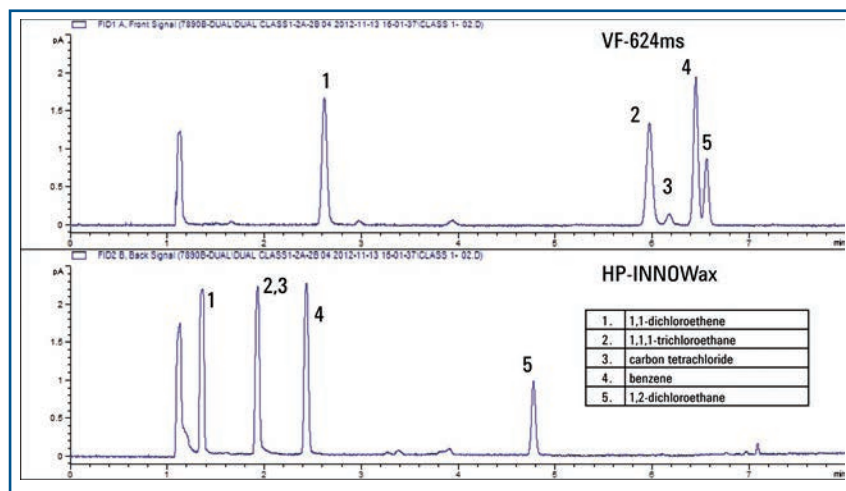

Agilent 7890A GC methods and equivalent results will transfer directly to the 7890B GC. 5991-1834EN: "Analysis of USP <467> Residual Solvents using the 7697A Headspace Sampler with the 7890B Gas Chromatograph"

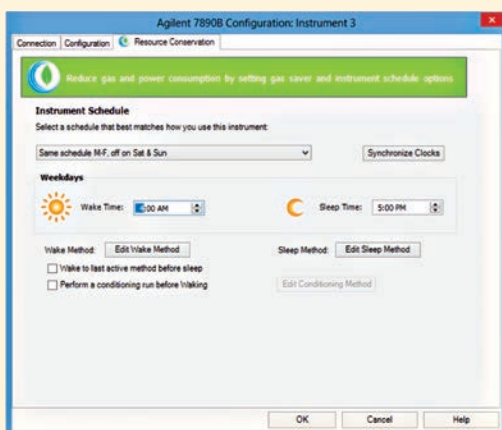

Save energy and conserve valuable resources. Sleep/wake mode lets you put your system to sleep when not in use, and have it awoken exactly when you need it.

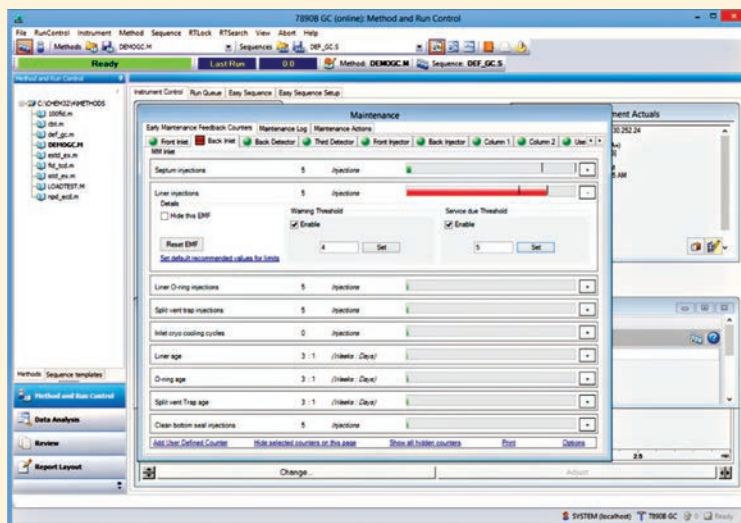

Early maintenance feedback (EMF) keeps track of injections and consumable usage, so you can establish maintenance SOPs.

Take your lab to a higher level of reliability and productivity

If your lab still uses an “old workhorse” GC just because it gives you “acceptable results,” perhaps it’s time to consider the transformative advantages of Agilent’s 7890B GC. It goes beyond “acceptable results” to give you increased productivity, safety, cost effectiveness, and environmental friendliness – all with greater precision and reliability than instruments past their prime.

Technology innovations expand your range of analyses:

- LTM technology that reduces cycle time for Simulated Distillation.
- An isothermal oven that enables rapid RGA with H₂S and O₂ separation.
- Pre-configured hardware and method-specific separation tools that let you focus on calibration and validation per your lab’s SOPs.

Factory-configured analyzers let you start your analysis immediately after installation

Our extensive portfolio of pre-tested, pre-configured GC and GC/MS analyzers let you focus on calibration and validation per your lab’s SOPs. They are designed specifically for energy and chemical applications such as refinery gas, natural gas, TOGA, standard, and alternative fuels.

Fast Simulated Distillation using Low Thermal Mass Module (LTM)

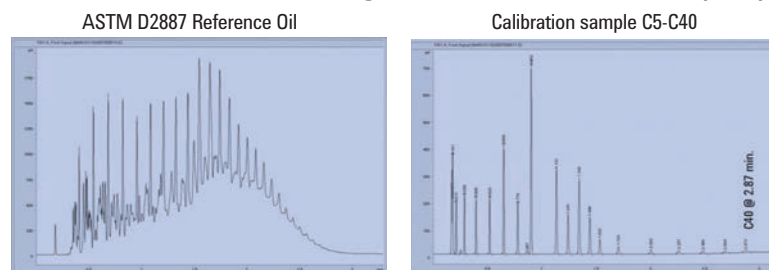

The simulated distillation results for ASTM D2887 RGO agree with the RGO specification of ASTM D2887, with RSDs of 0.12 to 0.47 percent across the reported percent off range.

5990-3174EN: Fast Hydrocarbon and Sulfur Simulated Distillation Using the Agilent Low Thermal Mass (LTM) System on the 7890 GC and 355 Sulfur Chemiluminescence Detector

Fast RGA Analysis

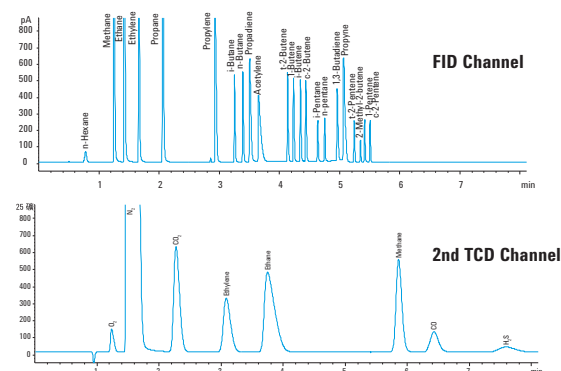

Oxygenates in finished gasoline per ASTM D4815

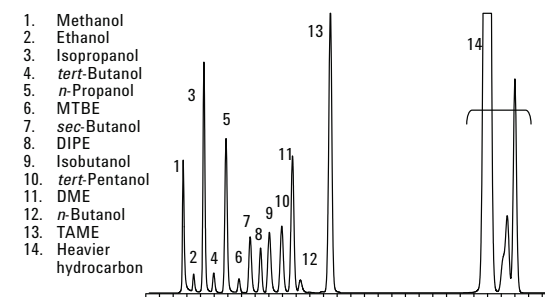

5991-1561EN: Analyzer Solution Guide for Energy & Chemicals Industry

Conform to industry requirements for sulfur levels

Sulfur distribution in feedstocks is critical to the refining industry as it adjusts to meet clean fuel requirements. Agilent's new Flame Photometric Detector, with its high temperature capability and improved sensitivity, is an ideal tool for determining sulfur in blending stocks, such as light cycle oil (LCO). Profiling dibenzothiophenes is particularly important for achieving the lowest sulfur levels in the final products.

For optimal results, the FPD must be operated at temperatures above 300 °C.

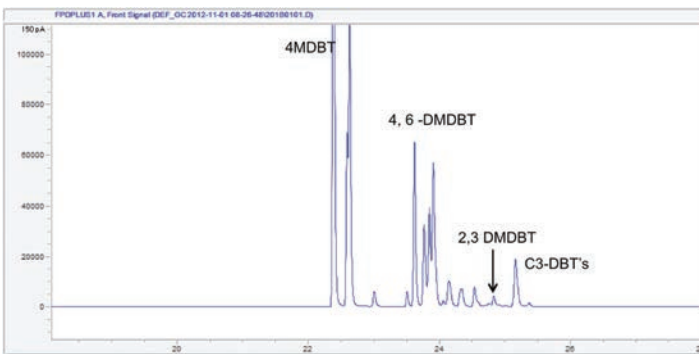

Analysis of substituted dibenzothiophenes in light cycle oil (LCO) using a CFT Deans Switch system with an Agilent 7890B FPD. This enhanced separation reduces the possibility for quenching caused by co-elution with hydrocarbons.

5991-1752EN: An Improved Flame Photometric Detector For the Analysis of Alkylidibenzothiophenes in Light Cycle Oil, and Gas Oil Feedstocks using the 7890B



Reliable trace sulfur analysis. Excellent reproducibility was achieved by coupling the Agilent 7890B GC with our sensitive, high-temperature FPD.

Comprehensive GC flow modulation

The Agilent 7890B GC uses Capillary Flow Technology to enable flow modulation without the need for complicated – and costly – cryo-focusing techniques. This analysis of diesel fuel shows the normal boiling point distribution in the first dimension, and functional group clusters in the second dimension.

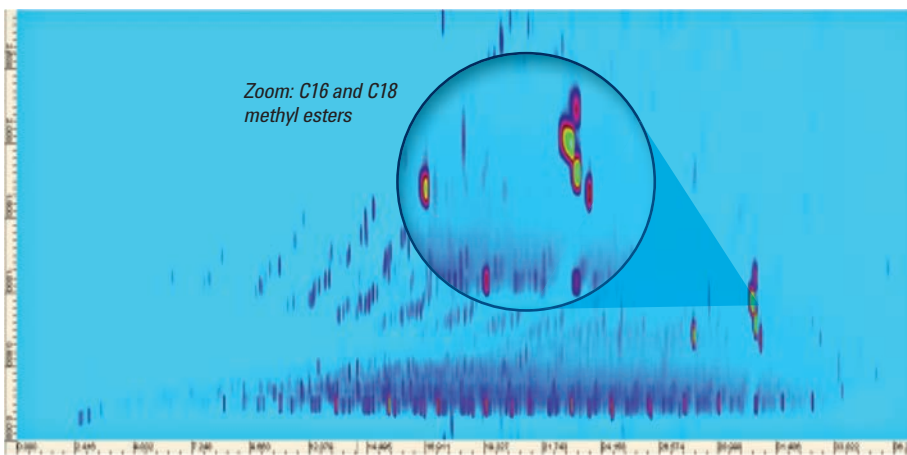

GC x GC of a B20 Biodiesel showing separation of the C16 and C18 methyl esters. Column 1: 20 m x 0.18 mm x 0.18 µm DB1, Column 2: 4 m x 0.24 mm x 0.25 µm HP-INNOWax. Modulation period: 2.800 seconds.

5989-9889EN: Capillary Flow Technology: GC x GC Flow Modulator: Get a Second Dimension of Information on Complex Mixtures

To learn more about the Agilent 7890B GC, visit www.agilent.com/chem/7890B

Simplify and accelerate complex screening methods

US EPA Method 8270 is widely used to determine the concentration of semi-volatile organic compounds in environmental matrices – many of which contain a mix of acids, bases, and neutrals. This method can be challenging, due to interactions between analytes and flow path surfaces.

Semi-volatiles analysis

Here, a 5 ppm EPA 8270 standard run was spiked into 5000 ppm of heavy oil to simulate interference from hazardous waste.

During the first run, peaks of interest eluted in less than 16 minutes, but a 24-minute bake-out at 320 °C was required to elute heavy components. The sample was rerun with a 4-minute backflush, which cut the cycle time by 20 minutes per run – a 50% total cycle time savings. ALS overlap and faster cool down saved an additional 4 minutes per cycle.

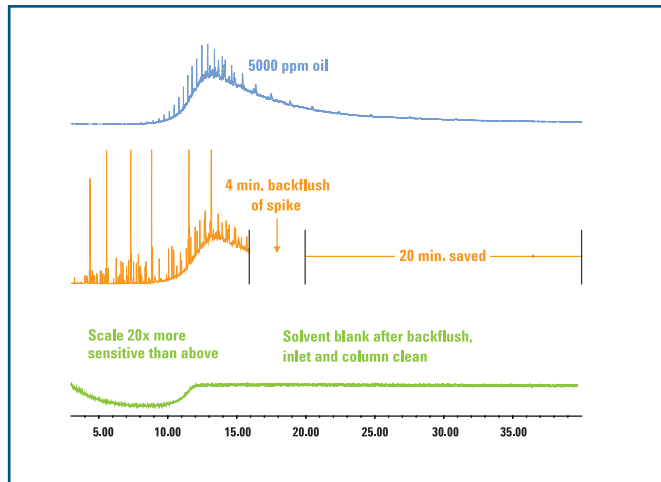

5989-6026EN: Significant Cycle Time Reduction Using the Agilent 7890/5975 GC/MSD for EPA Method 8270

Analysis of TPH (Mineral Oil)

Fast oven temperature programming using a low-thermal-mass system reduces cycle time and increases sensitivity for GC-FID analysis of mineral oil in environmental samples.

This technique meets regulated method requirements for analyzing the C10-C40 hydrocarbon fraction in soil and water extracts using splitless injection. The total analytical cycle time was *less than five minutes*.

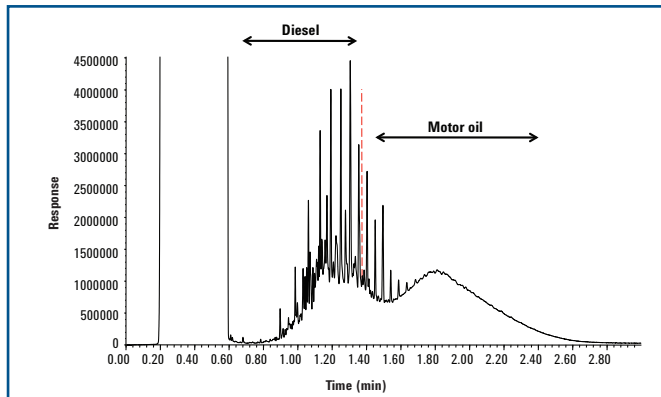

5990-9104EN: High Throughput Mineral Oil Analysis (Hydrocarbon Oil Index) by GC-FID using the Agilent Low Thermal Mass (LTM II) System

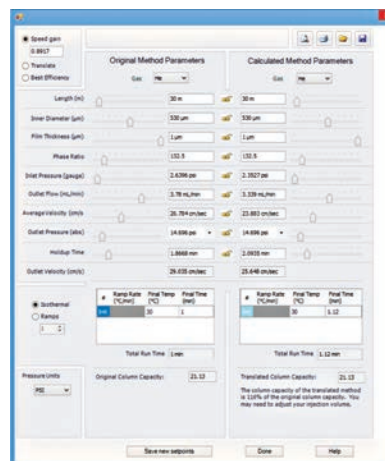

Method Calculator makes it easy to set up a method that shortens analysis time or facilitates the changing of carrier gas.

Confidently execute your most specialized analyses

Lower your pesticide detection limits with the Agilent Multimode Inlet (MMI)

Agilent's MMI has the same form factor and uses the same consumables (such as liners, O-rings, and septa) as our split/splitless inlet, so you can replicate your existing hot splitless methods. Its temperature programmability also lets you perform both cold splitless and large-volume injection (LVI) methods for improved detection limits.

In addition, an integrated Solvent Elimination Calculator provides a complete set of initial conditions for easy LVI method development.

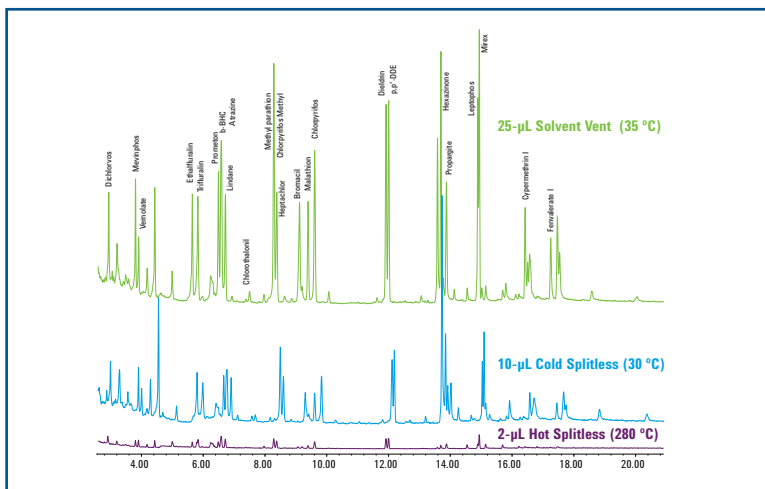

Total ion chromatogram comparing a 25- μ L solvent vent injection with a 2- μ L hot splitless injection for 40-ppb pesticides. Note the significant signal-to-noise improvement (lower detection limits).

5990-4169EN: Achieving Lower Detection Limits Easily with the Agilent Multimode Inlet (MMI)

Pesticides in milk extract: Flow splitting enables multiple detectors – increasing productivity

Agilent's flow splitting device proportionally splits column effluent to multiple detectors: MSD, DFPD and μ ECD. Full-scan TIC from the MSD provides quantitation and confirmation, while element-specific GC signals highlight trace-level compounds to be identified by the MSD.

The splitter also provides backflush capabilities to shorten cycle time and increase column life. Backflushing reduces ion source contamination by preventing column bleed and stopping heavy residues from being introduced into the MSD. It also eliminates carryover from any sample that accumulates at the column head, improving data integrity.

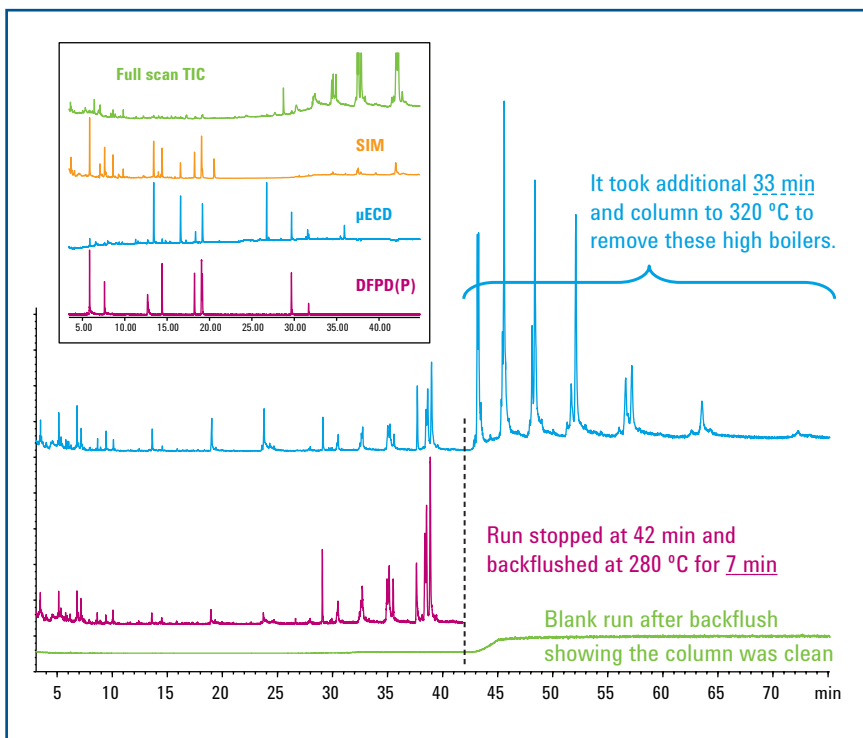

Four chromatograms collected simultaneously from a single injection of milk extract.

5989-6018EN: Improving Productivity and Extending Column Life with Backflush

To learn more about the Agilent 7890B GC, visit www.agilent.com/chem/7890B

Screen and quantitate target compounds in complex matrices

Rapid drug screening: Obtain more information in less time

GC/NPD/MSD with simultaneous SIM/Scan offers advantages such as broad-range screening for unlimited targets, full-spectrum identity confirmation, and non-target identification through Deconvolution Reporting Software (DRS) library searches.

This system collects Scan, SIM, and NPD data simultaneously. Scan is used to screen for 725 tox compounds. SIM is used for select low-level targets. NPD is used for confirmation aid and highlighting suspicious non-targets.

An Agilent Capillary Flow device splits column eluent, allowing the simultaneous acquisition of NPD and MSD data – and eliminating the need for multiple runs on different GCs. CFT Backflush further reduces cycle time and stabilizes retention times.

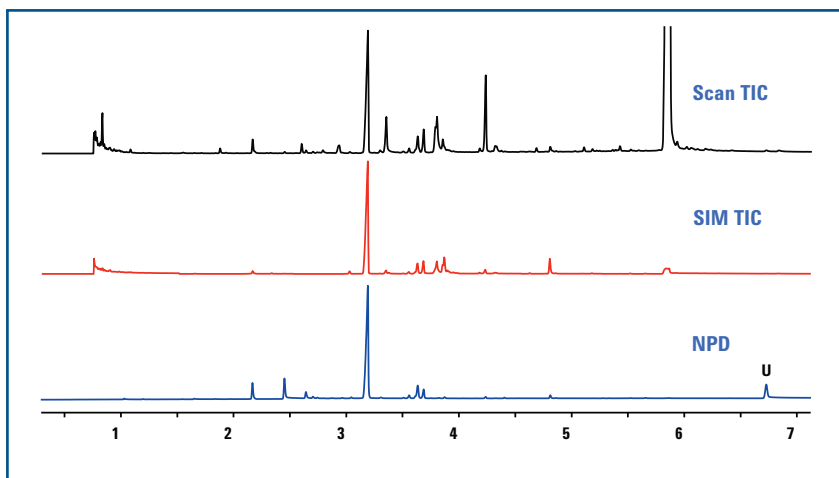

Toxicology screen on real blood extract.

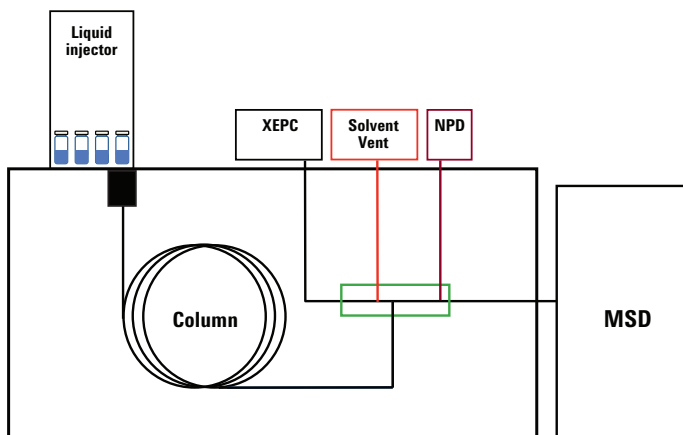

The GC/NPD/MSD configuration allows:

- (1) Splitting column effluent to NPD and MSD
- (2) Solvent venting
- (3) Backflushing
- (4) No-vent column changing

(Note: The MSD shown here is for illustration only. The MSD is actually on the left side of the GC).

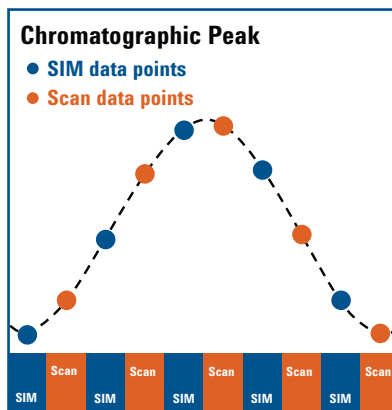

MSD SIM and Scan data points are alternately collected, with two separate data signals constructed at the end of the run. Each data signal can be processed like a SIM or Scan signal collected separately.

Inlets, detectors, and accessories expand the possibilities of system configuration

A wide inlet selection lets you optimize your system for *your* analysis

- Split/splitless (SSL) capillary
- Inert flow path split/splitless (ISSL) capillary
- Multimode inlet (MMI)
- Purged packed injection port (PPIP)
- Cool on-column (COC)
- Cool on-column with solvent vapor exit (COC-SVE)
- Programmable temperature vaporizing (PTV)
- Volatiles interface (VI)
- High-pressure gas sample injection
- Gas sampling valve (GSV)
- Liquid sampling valve (LSV)



The Agilent 7890B GC provides a versatile platform for all system configurations.

High-sensitivity detectors accommodate every sample type

- Mass selective detector (MSD)
- Triple Quadrupole MS
- Q-TOF MS
- Ion Trap MS
- ICP-MS
- Flame ionization (FID)
- Thermal conductivity (TCD)
- Micro-electron capture (Micro ECD)
- Flame photometric, single- or dual-wavelength (FPD)
- Nitrogen-phosphorus (NPD)
- Sulfur chemiluminescence (SCD)
- Nitrogen chemiluminescence (NCD)
- Atomic emission (AED)*
- Pulsed flame photometric (PFPD)*
- Photoionization (PID)*
- Electrolytic conductivity (ELCD)*
- Halogen Specific Detector (XSD)*
- Oxygenate Flame Ionization Detector (O-FID)*
- Pulsed Discharge Helium Ionization Detector (PDHID)*

** Available through Agilent Channel Partners. Contact Agilent for other custom configurations, and additional solutions available through Agilent Channel Partners*

Customized to get you
on the **FAST TRACK**



GC and GC/MS Analyzers let you focus on system validation and data generation... not method development

Agilent GC and GC/MS Analyzers are factory configured and chemically tested to meet method requirements, and get you on the "Fast Track" to producing quality data and processing sample backlogs.

More than just instruments, Agilent Analyzers are complete workflow solutions that incorporate advanced technologies, such as Capillary Flow Technology and target compound databases that allow us to optimize your system for your unique application.

Each Analyzer arrives ready to perform with pre-set chromatography and checkout samples to verify separation capabilities. That means your team can work toward system validation as soon as installation is complete – and significantly reduce your method development costs. And as always, our support team is available, should any problems arise.

To learn more about the Agilent 7890B GC, visit www.agilent.com/chem/7890B

Reliably extract and concentrate samples from complex matrices



Agilent Bond Elut QuEChERS Kits make sample preparation easier and more reliable

Pre-packaged Agilent QuEChERS Kits capture the time-saving benefits of QuEChERS sample preparation.

- **Extraction kits** with pre-weighed salts in anhydrous packets allow you to add salts *after* you add organic solvent to your sample – avoiding an exothermic reaction that can compromise analyte recovery
- **Dispersive kits** with sorbents and salts supplied in 2 mL or 15 mL centrifuge tubes accommodate the aliquot volumes specified by current AOAC and EN methodologies
- **Ceramic homogenizers** break up salt agglomerates, promoting consistent sample extraction and increasing product recovery during extraction and dispersion

Agilent Bond Elut SPE: A full line of sample preparation products to support your lab

Bond Elut SPE products deliver the quality and performance you expect from the industry's leading manufacturer of chromatography instruments, columns, and supplies.

- **A wide selection** of polymer, silica, and other sorbents in formats ranging from multiple cartridge sizes to 96-well plates
- **Tri-functional silica bonding** provides greater stability than monomeric bonding, while increasing solvent compatibility
- **Industry-leading quality control processes** ensure consistent particle size, so you get superior flow-through and performance
- **A variety of vacuum manifolds and accessories** help you meet all your SPE challenges

To learn more, visit www.agilent.com/chem/sampleprep

Agilent stands behind every instrument with unmatched service and support



Compliance

With over 100,000 qualification deliveries, and decades of quality testing experience, Agilent is your trusted source for the system qualification and proof of calibration you need for regulatory compliance.



Agilent Value Promise

We guarantee you at least 10 years of instrument use from your date of purchase, or we will credit you with the residual value of the system toward an upgraded model.



Real-time support and reporting

Agilent Remote Advisor is a remote monitoring, diagnostic, and reporting feature now included in all Agilent Advantage service plans. It can help you preempt instrument problems to maximize your uptime and productivity.



Agilent Service Guarantee

If your Agilent instrument requires service while covered by an Agilent service agreement, we guarantee the repair, or we will replace your instrument for free.



Workflow Services

Capillary Flow Technology (CFT) Backflush and Backflush Assistant Software Wizard training are available through Agilent Workflow Services. Expert assistance in setting up your CFT Backflush method is just a phone call away.

To learn more about the Agilent 7890B GC, visit www.agilent.com/chem/7890B

The Agilent 7890B Series GC

Resolve your search for integration, reliability, and intelligence



- **Powerful software tools** for data acquisition, analysis, and reporting help you get the most out of your instrument
- **Integrated Parts Finder tool and database** makes it easy to find and order columns, supplies, and parts
- **Agilent Inert Flow Path solutions** ensure a reliably inert GC flow path for higher sensitivity, accuracy, and reproducibility – especially at trace levels
- **5th-generation electronic pneumatics control**, combined with improved specifications, raises the bar on GC performance
- **Direct GC ↔ MSD communication** minimizes downtime while conserving power and gas
- **Eco-friendly features**, such as sleep/wake modes, conserve electricity and other resources
- **Early maintenance feedback** keeps the system performing at its best
- **Fast oven cool-down**, new backflush capabilities, and advanced automation boost your productivity



Experience the most feature rich and advanced 7890B GC and 5977A Series GC/MSD at www.agilent.com/chem/resolve

For more information

Learn more

www.agilent.com/chem/7890B

U.S. and Canada

1-800-227-9770

agilent_inquiries@agilent.com

In other countries, please call your local Agilent Representative or Agilent Authorized Distributor – visit www.agilent.com/chem/contactus

Information, descriptions, and specifications in this publication are subject to change without notice.

© Agilent Technologies, Inc. 2013
Printed in the USA February 1, 2013
5991-1836EN



Agilent Technologies