

Agilent 6100 Series Single Quad LC/MS Systems

Maintenance Guide



Agilent Technologies

Notices

© Agilent Technologies, Inc.
2006-2010,2013

No part of this manual may be reproduced in any form or by any means (including electronic storage and retrieval or translation into a foreign language) without prior agreement and written consent from Agilent Technologies, Inc. as governed by United States and international copyright laws.

Manual Part Number

G1960-90154

Edition

Fourth Edition, October 2013

Printed in USA

Agilent Technologies, Inc.
5301 Stevens Creek Blvd.
Santa Clara, CA 95051

Warranty

The material contained in this document is provided “as is,” and is subject to being changed, without notice, in future editions. Further, to the maximum extent permitted by applicable law, Agilent disclaims all warranties, either express or implied, with regard to this manual and any information contained herein, including but not limited to the implied warranties of merchantability and fitness for a particular purpose. Agilent shall not be liable for errors or for incidental or consequential damages in connection with the furnishing, use, or performance of this document or of any information contained herein. Should Agilent and the user have a separate written agreement with warranty terms covering the material in this document that conflict with these terms, the warranty terms in the separate agreement shall control.

Technology Licenses

The hardware and/or software described in this document are furnished under a license and may be used or copied only in accordance with the terms of such license.

Restricted Rights Legend

U.S. Government Restricted Rights. Software and technical data rights granted to the federal government include only those rights customarily provided to end user customers. Agilent provides this customary commercial license in Software and technical data pursuant to FAR 12.211 (Technical Data) and 12.212 (Computer Software) and, for the Department of Defense, DFARS 252.227-7015 (Technical Data - Commercial Items) and DFARS 227.7202-3 (Rights in Commercial Computer Software or Computer Software Documentation). Safety Notices

CAUTION

A **CAUTION** notice denotes a hazard. It calls attention to an operating procedure, practice, or the like that, if not correctly performed or adhered to, could result in damage to the product or loss of important data. Do not proceed beyond a **CAUTION** notice until the indicated conditions are fully understood and met.

WARNING

A **WARNING** notice denotes a hazard. It calls attention to an operating procedure, practice, or the like that, if not correctly performed or adhered to, could result in personal injury or death. Do not proceed beyond a **WARNING** notice until the indicated conditions are fully understood and met.

Contents

1	Maintenance	7
	Electrospray Ion Source	8
	To flush the nebulizer	8
	To clean the electrospray spray chamber daily	9
	To clean the electrospray spray chamber weekly	11
	To remove the electrospray nebulizer	14
	To replace the electrospray nebulizer needle	15
	To adjust the electrospray nebulizer needle	19
	To reinstall the electrospray nebulizer	21
	ESI with Agilent Jet Stream Technology	22
	To flush the nebulizer daily	22
	To flush the nebulizer monthly	23
	To clean the spray chamber daily for the ESI with Agilent Jet Stream	24
	To clean the spray chamber weekly for the ESI with Agilent Jet Stream	26
	To remove the nebulizer for the ESI with Agilent Jet Stream	30
	To replace the nebulizer needle for the ESI with Agilent Jet Stream	31
	To adjust the nebulizer needle for the ESI with Agilent Jet Stream	34
	To reinstall the nebulizer for the ESI with Agilent Jet Stream	36
	APCI Source	37
	To clean the APCI spray chamber daily	37
	To clean the APCI spray chamber weekly	40
	To remove the APCI nebulizer	42
	To replace the APCI nebulizer needle	43
	To adjust the APCI nebulizer needle	46
	To reinstall the APCI nebulizer	48
	To clean the corona needle	49
	To replace the corona needle	51

Contents

Multimode Source	53
To open the multimode source	53
To clean the multimode source daily	56
To clean the multimode source weekly	58
Ion Transfer Capillary	60
To remove the capillary	60
To clean the capillary	62
To reinstall the capillary	65
Desolvation Assembly	66
To remove the desolvation assembly	66
To clean skimmer 1	68
To reinstall the desolvation assembly	69
Calibrant Delivery System and Divert Valve	70
To check calibrant levels	73
To fill a calibrant bottle	74
To flush the calibrant delivery system	76
To check for leaks	77
To replace the LC filter elements	79
To replace the MS selection valve rotor seal	80
Analyzer and Ion Optics Assembly	81
To open the analyzer	81
To replace the electron multiplier horn	82
To clean the high energy dynode	83
To close the analyzer	85
To clean the ion optics assembly	86
Vacuum System	95
To check the rough pump fluid level (Agilent MS40+)	95
To check the rough pump fluid level (Edwards E1M18)	96
To check the oil mist filter (Edwards E1M18)	98
To add rough pump fluid	99
To replace the rough pump fluid	101

To replace the fuses 103
To bake out the LC/MS 105

2 Reference 107

Safety 108
Environmental Conditions 109
Replaceable Fuses 109

Contents

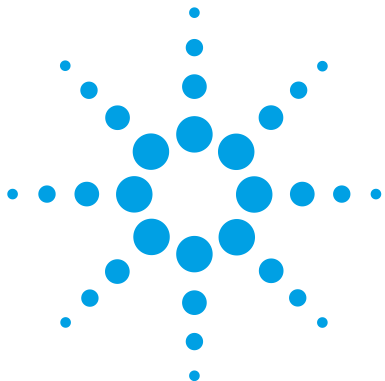

1 Maintenance

Electrospray Ion Source	8
ESI with Agilent Jet Stream Technology	22
APCI Source	37
Multimode Source	53
Ion Transfer Capillary	60
Calibrant Delivery System and Divert Valve	70
Analyzer and Ion Optics Assembly	81
Vacuum System	95

This chapter contains maintenance tasks for the Agilent 6100 Series Single Quad LC/MS System.



Electrospray Ion Source

This section describes the removal, disassembly, cleaning, and reassembly of the API-interface and the assemblies that make up the source.

To flush the nebulizer

When required Daily or at the end of each shift (or more often) to flush traces of samples and buffers out of the tubing, valves and nebulizer.

Tools required

- Acetonitrile, HPLC-grade or better
- Water, HPLC-grade or better

Parts required None

1 Make sure acetonitrile and water are two of the solvents installed in your liquid chromatograph.

NOTE

This procedure applies to both electrospray and APCI nebulizer.

2 Set the liquid chromatograph to pump a mixture of 90% acetonitrile and 10% water at 2 mL/minute.

3 Pump this mixture through the nebulizer for 3 minutes.

NOTE

This is a good general-purpose flushing mixture but you may need to adjust it based on the solvents, samples and buffers you are using. For example, a mixture of 50% acetonitrile and 50% water works well for removing salts.

To clean the electrospray spray chamber daily

When required Daily or at the end of each shift or anytime you suspect carryover contamination from one sample or analysis to another.

Tools required

- Cloths, clean, lint-free (p/n 05980-60051)
- Gloves, clean
- Isopropanol, reagent grade or better
- Mobile phase, current
- Wash bottle, clean
- Water, reagent-grade or better

Parts required None

NOTE

Recent residue should be soluble in the mobile phase. If you are not sure what mobile phase was used recently, a mixture of 50% isopropanol and 50% water works well as a general cleaning solution.

- 1 Prepare the mobile phase you have been using.
- 2 Turn off the spray chamber.

WARNING

The electrospray spray chamber operates at high temperatures. Allow sufficient time to cool down before cleaning.

- 3 Remove the electrospray nebulizer.
- 4 Open the spray chamber ([Figure 1](#)).

1 Maintenance

To clean the electrospray spray chamber daily



Figure 1 Opened electrospray spray chamber

- 5 Rinse the interior of the spray chamber with the current mobile phase or with a mixture of isopropanol and water.

WARNING

Some mobile phases are dangerous. Use the degree of caution appropriate for the mobile phase being used.

- 6 Wipe the interior of the spray chamber with a clean, lint-free cloth.
- 7 Rinse the area around the spray shield.

CAUTION

Do not spray directly toward the tip of the capillary. This can cause pressure surges in the vacuum system.

- 8 Dampen a clean cloth with the mobile phase.
- 9 Wipe the spray shield and the area around the spray shield.
- 10 Close the spray chamber.

WARNING

Use the weekly cleaning procedure if symptoms of contamination persist or if the spray shield or capillary cap show significant discoloration that cannot be removed by the regular, daily cleaning.

To clean the electrospray spray chamber weekly

When required Weekly or whenever symptoms indicate that contamination exists in the spray chamber and normal daily cleaning does not correct the problem.

- Tools required**
- Abrasive paper, 8000 grit (p/n 8660-0852)
 - Cloths, clean, lint-free (p/n 05980-60051)
 - Cotton swabs (p/n 5080-5400)
 - Gloves, clean
 - Isopropanol, reagent grade or better
 - Mobile phase, current
 - Wash bottle, clean
 - Water, reagent-grade or better

Parts required None

- 1 Prepare the mobile phase that you last used with the instrument.

Recent residue should be soluble in the mobile phase that was last used. If you are not sure what mobile phase was used recently, use a mixture of 50% isopropanol and 50% water as a general cleaning solution.

- 2 Turn off the spray chamber.

WARNING

The electrospray spray chamber operates at high temperatures. Allow sufficient time to cool down.

- 3 Remove the electrospray nebulizer.
- 4 Open the spray chamber and remove it from the LC/MS.
- 5 Fill the spray chamber with clean mobile phase, or with a mixture of isopropanol and water.

1 Maintenance

To clean the electrospray spray chamber weekly

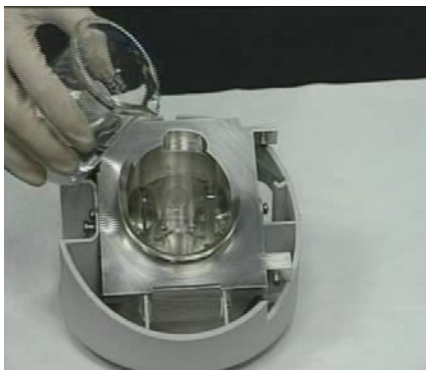

Figure 2 Filling the spray chamber

WARNING

Some mobile phases are dangerous. Use the degree of caution appropriate for the mobile phase being used.

- 6 Scrub the insulators and the interior of the spray chamber with a clean cotton swab.
- 7 Empty the spray chamber.
- 8 Reinstall the spray chamber on the instrument.
- 9 Remove the spray shield.
- 10 Use abrasive paper to gently clean the end of the capillary cap.



Figure 3 End of capillary cap

- 11 Use abrasive paper to gently clean the spray shield.
- 12 Dampen a clean cloth and wipe the end of the capillary cap.
- 13 Reinstall the spray shield.
- 14 Use abrasive paper to gently clean the spray shield.
- 15 Dampen a clean cloth and wipe the spray shield.
- 16 Rinse the area around the spray shield.



Figure 4 Rinsing the area around the spray shield

CAUTION

Do not spray directly toward the end of the capillary. This can cause pressure surges in the vacuum system.

- 17 Wipe the area around the spray shield.
- 18 Close the spray chamber.
- 19 Reinstall the electrospray nebulizer.

1 Maintenance

To remove the electrospray nebulizer

To remove the electrospray nebulizer

When required When you need to access the nebulizer for maintenance.

Tools required Gloves, clean

Parts required None

NOTE

Recent residue should be soluble in the mobile phase. If you are not sure what mobile phase was used recently, a mixture of 50% isopropanol and 50% water works well as a general cleaning solution.



Figure 5 Electrospray nebulizer

- 1 Shut off the flow of LC solvent.
- 2 Shut off the flow of nebulizing gas.
- 3 Slide back the plastic cover from over the nebulizer.
- 4 Disconnect the LC tubing and nebulizing gas tubing from the nebulizer.
- 5 Turn the nebulizer counterclockwise until it disengages from the retaining screws.
- 6 Gently lift the nebulizer out of the spray chamber.

WARNING

The tip of the nebulizer may be very hot. Allow it to cool before handling it.

To replace the electrospray nebulizer needle

When required When the needle is plugged. Common symptoms of a plugged needle are increased LC back pressure, off-axis spraying, or dripping from the nebulizer.

Tools required

- Adjustment fixture (p/n G1946-20215)
- Gloves, clean
- Pliers, long nose (p/n 7810-0004)
- Wrench 3-mm, open-end (p/n 8710-2699)
- Wrench ¼-inch x 5/16-inch, open-end (p/n 8710-0510)

Parts required Nebulizer needle kit, Electrospray, p/n G2427A (includes needle, ferrule, and needle holder)



Figure 6 Electrospray nebulizer needle in needle holder

- 1 Install the nebulizer in the adjustment fixture.
- 2 Loosen the locknut next to the zero-dead-volume (ZDV) union.

1 Maintenance

To replace the electrospray nebulizer needle



Figure 7

3 Remove the union from the nebulizer.



Figure 8

4 Loosen the locknut of the needle holder.

5 Unscrew the needle holder and pull it out of the nebulizer.



Figure 9

6 Slide the non-tapered end of the needle through the new needle holder from the narrower side.

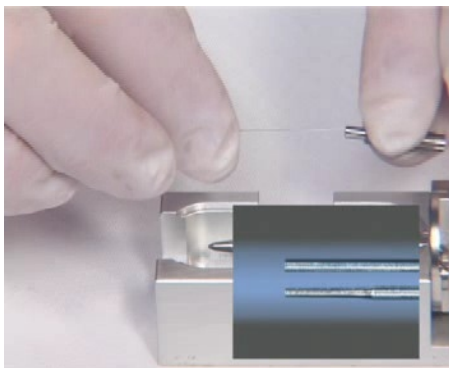

Figure 10 Sliding the non-tapered end of the needle through the new needle holder.

- 7** Push a new ferrule, flat-side first, onto the needle.

Be sure the needle does not extend from the ferrule.

- 8** Reinstall the locknut and the union. Hand-tighten the union.
- 9** Hold the needle holder steady with a 3-mm wrench. Tighten the union one-quarter to one-half turn to compress the ferrule.

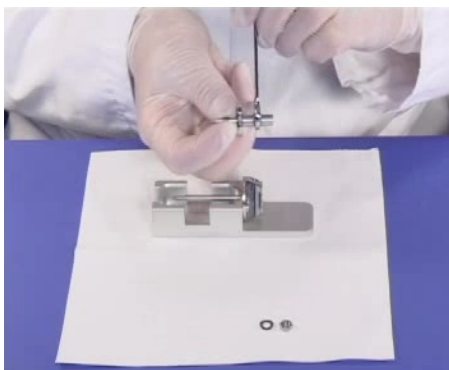

Figure 11 Tightening the union screw to compress the ferrule

- 10** Tighten the locknut against the union.
- 11** Pull carefully on the needle to ensure the needle is held firmly in place.
- 12** Replace locknut and washer.
- 13** Insert the needle into the nebulizer shaft.

1 Maintenance

To replace the electrospray nebulizer needle

CAUTION

Take care when inserting the needle. The tapered end of the needle must pass through the restrictions in the nebulizer shaft. The tip of the needle can be damaged if excessive force is applied.

14 Adjust the electrospray needle position before reinstalling the nebulizer in the spray chamber.

NOTE

Record this procedure in the Maintenance Logbook in the Diagnosis view of the system software.

To adjust the electrospray nebulizer needle

When required After replacing the electrospray nebulizer needle or if symptoms indicate the needle is not correctly adjusted,

- Tools required**
- Adjustment fixture (p/n G1946-20215)
 - Gloves, clean
 - Magnifier (p/n G1946-80049)
 - Wrench 3-mm, open-end (p/n 8710-2699)
 - Wrench ¼-inch x 5/16-inch, open-end (p/n 8710-0510)

Parts required None

- 1 Install the nebulizer in the adjustment fixture.



Figure 12

- 2 Loosen the needle holder locknut.
- 3 Position the magnifier so you can see the tip of the nebulizer.
- 4 Adjust the needle holder until the needle is even with the tip of the nebulizer.

1 Maintenance

To adjust the electrospray nebulizer needle

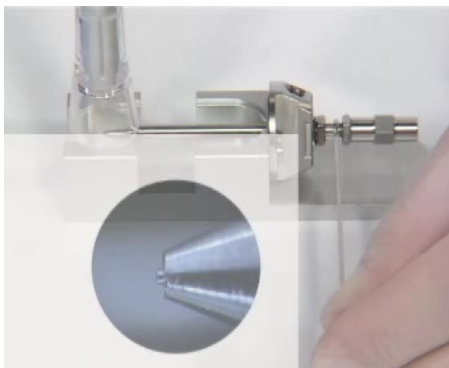

Figure 13 Adjusting the needle holder

- 5 Tighten the locknut. Make sure this does not change the position of the needle.
- 6 Remove the nebulizer from the adjustment fixture and reinstall it in the electrospray spray chamber.
- 7 Be very careful not to hit the tip of the nebulizer against anything. Any damage will have a large, negative effect on system performance.

CAUTION

Do not to hit the tip of the nebulizer against anything. A nebulizer with the needle extended is especially vulnerable. Any damage will have a large, negative effect on system performance.

NOTE

Record this procedure in the Maintenance Logbook in the Diagnosis view of the system software.

To reinstall the electrospray nebulizer

When required As necessary.

Tools required None

Parts required None

1 Insert the nebulizer part way into the spray chamber.

CAUTION

Do not hit the tip of the needle as you insert the nebulizer. The tip of the needle is easily damaged.

2 Reconnect the nebulizing gas tubing to the nebulizer.

3 Finish inserting the nebulizer into the spray chamber.

4 Turn the nebulizer clockwise and lock it in place.

5 Reconnect the LC tubing to the nebulizer.

CAUTION

Do not overtighten the LC fitting. Overtightening the fitting can crush the tubing, creating a restriction.

6 Close the nebulizer cover.

ESI with Agilent Jet Stream Technology

This section describes the removal, disassembly, cleaning, and reassembly of the electrospray interface with Agilent Jet Stream Technology.

To flush the nebulizer daily

When required Daily or at the end of each shift (or more often) to flush traces of samples and buffers out of the tubing, valves and nebulizer

Tools required

- Acetonitrile, HPLC-grade or better
- Water, HPLC-grade or better

Parts required None

- 1 Make sure acetonitrile and water are two of the solvents installed in your liquid chromatograph.
- 2 Set the liquid chromatograph to pump a mixture of 90% acetonitrile and 10% water at 2 mL/minute.
- 3 Pump this mixture through the nebulizer for 3 minutes.

NOTE

This is a good general-purpose flushing mixture but you may need to adjust it based on the solvents, samples and buffers you are using. For example, a mixture of 50% acetonitrile and 50% water works well for removing salts.

To flush the nebulizer monthly

When required Monthly or as needed at the end of each shift (or more often) to flush traces of samples and buffers out of the tubing, valves and nebulizer

Tools required

- HPLC Flushing Solvent
- Cyclohexane, HPLC-grade or better
- Acetonitrile, HPLC grade or better
- Alternatively if available: isooctane, HPLC-grade or better

Parts required None

- 1 Make sure HPLC flushing, cyclohexane, and acetonitrile are three of the solvents installed in your liquid chromatograph.
- 2 Pump HPLC flushing solvent for 10 minutes at 5 mL/minute.
- 3 Switch to cyclohexane, and pump for 10 minutes at 5 mL/minute.
- 4 Pump this mixture through the nebulizer for 3 minutes.
- 5 Prepare enough acetonitrile and flush overnight.

NOTE

This is a good general-purpose flushing mixture but you may need to adjust it based on the solvents, samples and buffers you are using. For example, substitute acetonitrile for isooctane for overnight flushing when heavy build-up is noticeable.

1 Maintenance

To clean the spray chamber daily for the ESI with Agilent Jet Stream

To clean the spray chamber daily for the ESI with Agilent Jet Stream

When required Daily or at the end of each shift or anytime you suspect carryover contamination from one sample or analysis to another

Tools required

- Cloths, clean, lint-free (p/n 05980-60051)
- Gloves, clean
- Isopropanol, reagent grade or better
- Mobile phase, current
- Wash bottle, clean
- Water, reagent-grade or better

Parts required None

NOTE

Recent residue should be soluble in the mobile phase. If you are not sure what mobile phase was used recently, use a mixture of 50% isopropanol and 50% water as a general cleaning solution.

- 1 Prepare the mobile phase you have been using.
- 2 Turn off the spray chamber.

WARNING

The electrospray with Agilent Jet Stream Technology spray chamber operates at high temperatures. Allow sufficient time to cool down before cleaning.

- 3 Remove the nebulizer.
- 4 Open the spray chamber (Figure 14).

To clean the spray chamber daily for the ESI with Agilent Jet Stream



Figure 14 Opened electro spray Agilent Jet Stream Technology spray chamber

- 5 Rinse the interior of the spray chamber with the current mobile phase or with a mixture of isopropanol and water.

WARNING

Some mobile phases are dangerous. Use the degree of caution appropriate for the mobile phase being used.

- 6 Wipe the interior of the spray chamber with a clean, lint-free cloth.
- 7 Rinse the area around the spray shield.

CAUTION

Do not spray directly toward the tip of the capillary. This can cause pressure surges in the vacuum system.

- 8 Dampen a clean cloth with the mobile phase.
- 9 Wipe the spray shield and the area around the spray shield.
- 10 Close the spray chamber.
- 11 Reinstall the electro spray nebulizer.

NOTE

Use the weekly cleaning procedure if symptoms of contamination persist or if the spray shield or capillary cap show significant discoloration that cannot be removed by the regular, daily cleaning.

1 Maintenance

To clean the spray chamber weekly for the ESI with Agilent Jet Stream

To clean the spray chamber weekly for the ESI with Agilent Jet Stream

When required Weekly or whenever symptoms indicate that contamination exists in the spray chamber and normal daily cleaning does not correct the problem

Tools required

- Abrasive paper, 8000 grit (p/n 8660-0852)
- Cloths, clean, lint-free (p/n 05980-60051)
- Cotton swabs (p/n 5080-5400)
- Gloves, clean
- Isopropanol, reagent grade or better
- Mobile phase, current
- Wash bottle, clean
- Water, reagent-grade or better

Parts required None

NOTE

Recent residue should be soluble in the mobile phase. If you are not sure what mobile phase was used recently, a mixture of 50% isopropanol and 50% water works well as a general cleaning solution.

1 Turn off the spray chamber.

WARNING

The electrospray spray chamber operates at high temperatures. Allow sufficient time to cool down.

2 Remove the electrospray nebulizer.

3 Open the spray chamber and remove it from the LC/MS.

4 Fill the spray chamber with clean mobile phase, or with a mixture of isopropanol and water.

To clean the spray chamber weekly for the ESI with Agilent Jet Stream

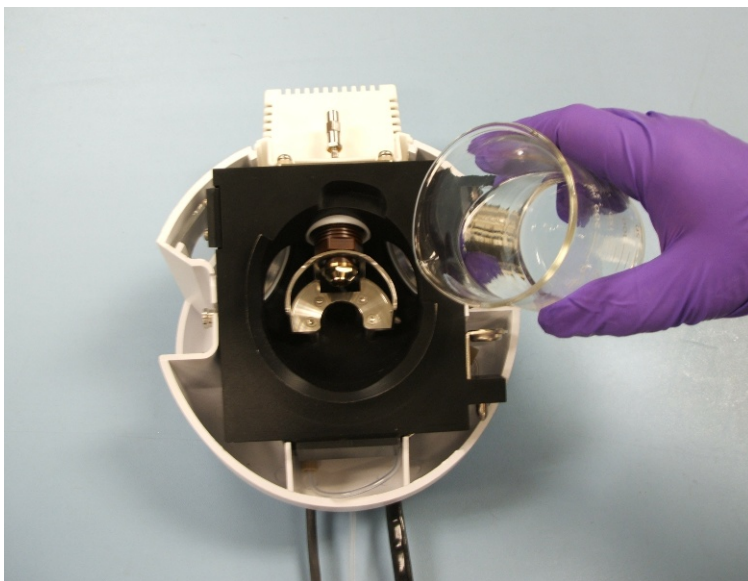

Figure 15 Filling the spray chamber

WARNING

Some mobile phases are dangerous. Use the degree of caution appropriate for the mobile phase being used.

- 5 Scrub the insulators and the interior of the spray chamber with a clean cotton swab.
- 6 Empty the spray chamber.
- 7 Reinstall the spray chamber on the instrument.
- 8 Remove the spray shield.
- 9 Use abrasive paper to gently clean the end of the capillary cap.

1 Maintenance

To clean the spray chamber weekly for the ESI with Agilent Jet Stream



Capillary cap

Figure 16 End of capillary cap

10 Dampen a clean cloth and wipe the end of the capillary cap.

11 Reinstall the spray shield.

12 Use abrasive paper to gently clean the spray shield.

13 Dampen a clean cloth and wipe the spray shield.

14 Rinse the area around the spray shield.



Figure 17 Rinsing the area around the spray shield

CAUTION

Do not spray directly toward the tip of the capillary. This can cause pressure surges in the vacuum system.

To clean the spray chamber weekly for the ESI with Agilent Jet Stream

- 15** Wipe the area around the spray shield.
- 16** Close the spray chamber.
- 17** Reinstall the electrospray nebulizer.

1 Maintenance

To remove the nebulizer for the ESI with Agilent Jet Stream

To remove the nebulizer for the ESI with Agilent Jet Stream

When required When you need to access the nebulizer for maintenance

Tools required Gloves, clean

Parts required None

NOTE

Recent residue should be soluble in the mobile phase. If you are not sure what mobile phase was used recently, a mixture of 50% isopropanol and 50% water works well as a general cleaning solution.



Figure 18 Electrospray nebulizer

- 1 Shut off the flow of LC solvent.
- 2 Shut off the flow of nebulizing gas.
- 3 Slide back the plastic cover from over the nebulizer.
- 4 Disconnect the LC tubing and nebulizing gas tubing from the nebulizer.
- 5 Turn the nebulizer counterclockwise until it disengages from the retaining screws.
- 6 Gently lift the nebulizer out of the spray chamber.

WARNING

The tip of the nebulizer may be very hot. Allow it to cool before handling it.

To replace the nebulizer needle for the ESI with Agilent Jet Stream

When required When the needle is plugged. Common symptoms of a plugged needle are increased LC back pressure or off-axis spraying or dripping from the nebulizer.

- Tools required**
- Adjustment fixture (p/n G1946-20215)
 - Gloves, clean
 - Pliers, long nose (p/n 7810-0004)
 - Wrench 3-mm, open-end (p/n 8710-2699)
 - Wrench ¼-inch x 5/16-inch, open-end (p/n 8710-0510)

Parts required Nebulizer accessory kit, ES with Agilent Jet Stream p/n G1958-60137

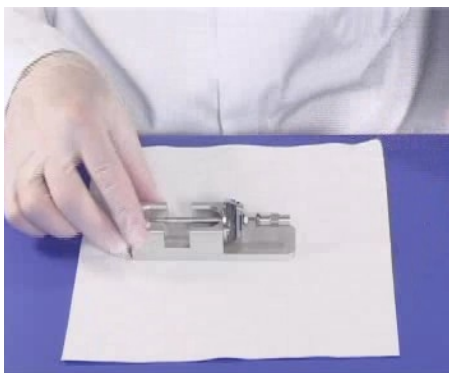

Figure 19 Electrospray nebulizer needle in needle holder

- 1 Install the nebulizer in the adjustment fixture.
- 2 Loosen the locknut next to the zero-dead-volume (ZDV) union.



Figure 20

1 Maintenance

To replace the nebulizer needle for the ESI with Agilent Jet Stream

- 3 Remove the union from the nebulizer.



Figure 21

- 4 Loosen the locknut of the needle holder.
- 5 Unscrew the needle holder and pull it out of the nebulizer.



Figure 22

- 6 Slide the non-tapered end of the needle through the new needle holder from the narrower side.

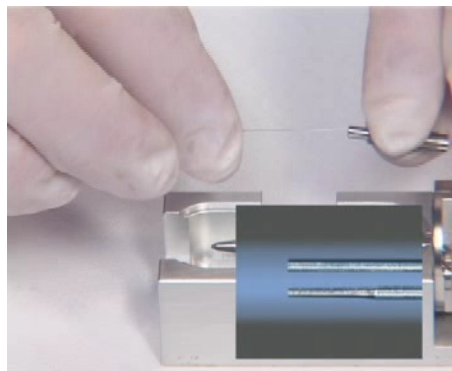

Figure 23 Sliding the non-tapered end of the needle through the new needle holder

To replace the nebulizer needle for the ESI with Agilent Jet Stream

- 7 Push a new ferrule, flat-side first, onto the needle.
- 8 Be sure the needle does not extend from the ferrule.
- 9 Reinstall the locknut and the union. Hand tighten the union.
- 10 Hold the needle holder steady with a 3-mm wrench. Tighten the union one-quarter to one-half turn to compress the ferrule.

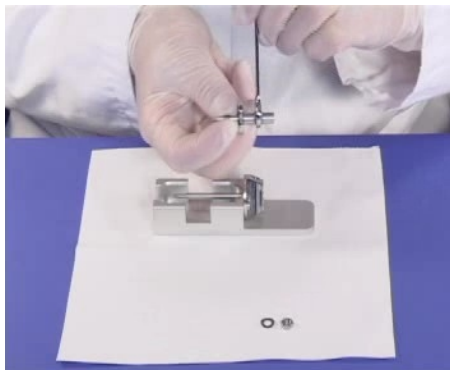

Figure 24 Tightening the union screw to compress the ferrule

- 11 Tighten the locknut against the union.
- 12 Pull carefully on the needle to ensure the needle is held firmly in place.
- 13 Replace locknut and washer.
- 14 Insert the needle into the nebulizer shaft.

CAUTION

Take care when inserting the needle. The tapered end of the needle must pass through the restrictions in the nebulizer shaft. The tip of the needle can be damaged if excessive force is applied.

- 15 Adjust the electrospray needle position before reinstalling the nebulizer in the spray chamber.

NOTE

Record this procedure in the Maintenance Logbook.

1 Maintenance

To adjust the nebulizer needle for the ESI with Agilent Jet Stream

To adjust the nebulizer needle for the ESI with Agilent Jet Stream

When required After replacing the electrospray nebulizer needle or if symptoms indicate the needle is not correctly adjusted

Tools required

- Adjustment fixture (p/n G1946-20215)
- Gloves, clean
- Magnifier (p/n G1946-80049)
- Wrench 3-mm, open-end (p/n 8710-2699)
- Wrench ¼-inch x 5/16-inch, open-end (p/n 8710-0510)

Parts required None

- 1 Install the nebulizer in the adjustment fixture.



Figure 25

- 2 Loosen the needle holder locknut.
- 3 Position the magnifier so you can see the tip of the nebulizer.
- 4 Adjust the needle holder until the needle is even with the tip of the nebulizer.

To adjust the nebulizer needle for the ESI with Agilent Jet Stream

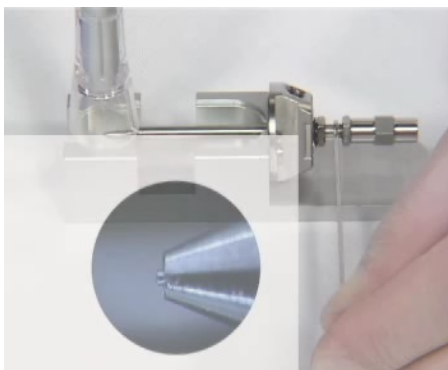

Figure 26 Adjusting the needle holder

- 5** Tighten the locknut. Make sure this does not change the position of the needle.
- 6** Remove the nebulizer from the adjustment fixture and reinstall it in the electrospray spray chamber.
- 7** Be very careful not to hit the tip of the nebulizer against anything. Any damage will have a large, negative effect on system performance.

CAUTION

Do not to hit the tip of the nebulizer against anything. A nebulizer with the needle extended is especially vulnerable. Any damage will have a large, negative effect on system performance.

NOTE

Record this procedure in the Maintenance Logbook in the Diagnosis view of the system software.

1 Maintenance

To reinstall the nebulizer for the ESI with Agilent Jet Stream

To reinstall the nebulizer for the ESI with Agilent Jet Stream

When required As necessary

Tools required None

Parts required None

1 Insert the nebulizer part way into the spray chamber.

CAUTION

Do not hit the tip of the needle as you insert the nebulizer. The tip of the needle is easily damaged.

2 Reconnect the nebulizing gas tubing to the nebulizer.

3 Finish inserting the nebulizer into the spray chamber.

4 Turn the nebulizer clockwise and lock it in place.

5 Reconnect the LC tubing the nebulizer.

CAUTION

Do not overtighten the LC fitting. Overtightening the fitting can crush the tubing, which creates restriction.

6 Close the nebulizer cover.

APCI Source

This section describes how to open and close the APCI source and maintain it.

To clean the APCI spray chamber daily

When required Daily at the end of each shift or anytime you suspect carryover contamination from one sample or analysis to another.

Tools required

- Cloths, clean, lint-free (p/n 05980-60051)
- Gloves, clean
- Isopropanol, reagent grade or better
- Mobile phase, current
- Wash bottle, clean
- Water, reagent-grade or better

Parts required None

WARNING

The APCI spray chamber operates at high temperatures. Allow sufficient time to cool down.

Some mobile phases are dangerous. Use the degree of caution appropriate for the mobile phase being used.

CAUTION

Do not spray the mobile phase upward into the vaporizer.

Do not spray directly toward the tip of the capillary. This can cause pressure surges in the vacuum system.

1 Maintenance

To clean the APCI spray chamber daily

NOTE

- Recent residue should be soluble in the mobile phase. If you are not sure what mobile phase was used recently, use a mixture of 50% isopropanol and 50% water as a general cleaning solution.
- Use the weekly cleaning procedure if symptoms of contamination persist, or if the spray shield or capillary cap shows significant discoloration that cannot be removed by the regular daily cleaning.

- 1 Turn off the spray chamber.
- 2 Remove the corona needle.
- 3 Make sure the needle has cooled and then carefully clean it with abrasive paper.
- 4 Open the spray chamber.

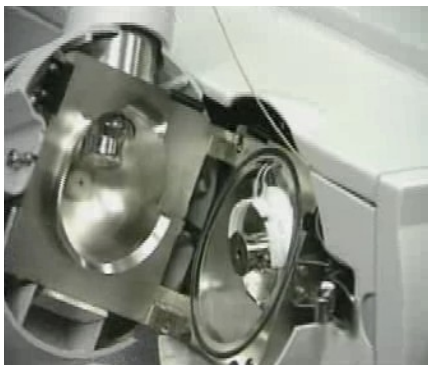

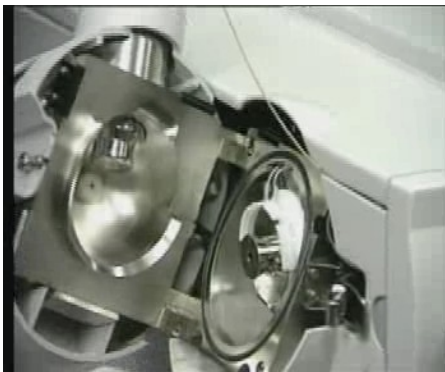

Figure 27 Opened spray chamber

- 5** Rinse the interior of the spray chamber with the current mobile phase or with a mixture of isopropanol and water.
- 6** Wipe the interior of the spray chamber and the end of the vaporizer with a clean cloth.
- 7** Remove the spray shield.
- 8** Use abrasive paper to gently clean the end of the capillary cap.
- 9** Dampen a clean cloth and wipe the end of the capillary cap.
- 10** Reinstall the spray shield.
- 11** Use abrasive paper to gently clean the spray shield.
- 12** Dampen a clean cloth and wipe the spray shield.
- 13** Rinse the area around the spray shield.
- 14** Wipe the area around the spray shield with a clean cloth.
- 15** Close the spray chamber.
- 16** Reinstall the corona needle.

1 Maintenance

To clean the APCI spray chamber weekly

To clean the APCI spray chamber weekly

When required Weekly or whenever symptoms indicate contamination in the spray chamber and the normal daily cleaning does not correct the problem.

Tools required

- Abrasive paper, 4000 grit (p/n 8660-0827)
- Cloth, clean, lint-free, 05980-60051
- Cotton swabs, 5080-5400
- Gloves, clean
- Isopropanol, reagent grade or better
- Mobile phase, current
- Wash bottle
- Water, reagent-grade or better

Parts required None

1 Prepare the mobile phase you have been using.

Recent residue should be soluble in the mobile phase. If you are not sure what mobile phase was used recently, use a mixture of 50% isopropanol and 50% water as a general cleaning solution.

2 Turn off the spray chamber.

3 The APCI spray chamber operates at high temperatures. Allow sufficient time to cool down.

4 Remove the corona needle.

5 Make sure the needle has cooled and then carefully clean it with abrasive paper.

6 Open the spray chamber.

7 Rinse the interior of the spray chamber with the current mobile phase or with a mixture of isopropanol and water.

Some mobile phases are dangerous. Use caution that is appropriate for the current mobile phase.

CAUTION

Do not spray the mobile phase upward into the vaporizer.

- 8 Wipe the interior of the spray chamber and the end of the vaporizer with a clean cloth.
- 9 Remove the spray shield.
- 10 Use abrasive paper to gently clean the end of the capillary cap.
- 11 Dampen a clean cloth and wipe the end of the capillary cap.
- 12 Reinstall the spray shield.
- 13 Use abrasive paper to gently clean the spray shield.
- 14 Dampen a clean cloth and wipe the spray shield.
- 15 Rinse the area around the spray shield.

CAUTION

Do not spray directly at the end of the capillary. This can cause pressure surges in the vacuum system.

- 16 Wipe the area around the spray shield with a clean cloth.
- 17 Close the spray chamber.
- 18 Reinstall the corona needle.

1 Maintenance

To remove the APCI nebulizer

To remove the APCI nebulizer

When required When you need to access the nebulizer for maintenance.

Tools required • Gloves, clean

Parts required None

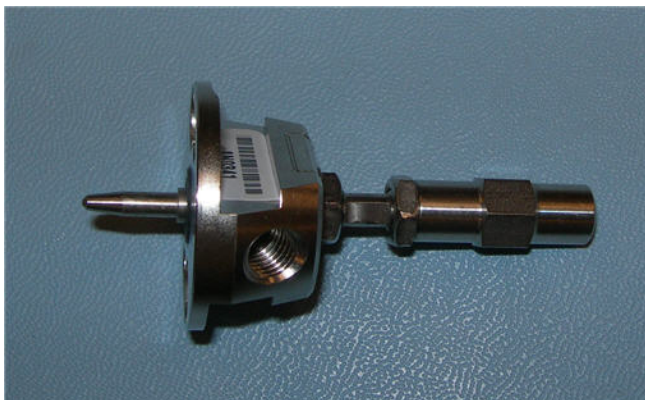

Figure 28 APCI nebulizer

- 1 Shut off the flow of LC solvent.
- 2 Shut off the flow of nebulizing gas.
- 3 Disconnect the LC tubing and nebulizing gas tubing from the nebulizer.
- 4 Turn the nebulizer counterclockwise until it disengages from the retaining screws.
- 5 Gently lift the nebulizer out of the spray chamber.

WARNING

The tip of the nebulizer may be very hot. Allow it to cool before handling it.

To replace the APCI nebulizer needle

- When required** When the needle is plugged. Common symptoms of a plugged needle are increased LC back pressure or off-axis spray from the nebulizer (difficult to see in an APCI system).
- Tools required**
- Adjustment fixture (p/n G1946-20215)
 - Gloves, clean, lint-free (large, p/n 8650-0030; small, p/n 8650-0029)
 - Pliers, long-nose (p/n 8710-0004)
 - Wrench 3-mm, open-end (p/n G1946-20203)
 - Wrench ¼-inch x 5/16-inch, 2 required (p/n 8710-0510)
- Parts required** Nebulizer needle kit, APCI (includes needle, ferrule, and needle holder, p/n G2428A).

- 1 Install the nebulizer in the adjustment fixture.

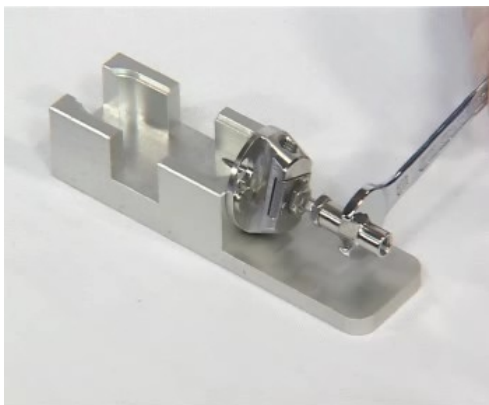

Figure 29 Installing the nebulizer in the adjustment fixture

- 2 Loosen the locknut next to the zero-dead-volume (ZDV) union.
- 3 Remove the union from the nebulizer.
- 4 Loosen the locknut of the needle holder.
- 5 Unscrew the needle holder and pull it out of the nebulizer.
- 6 Slide the non-tapered end of the needle through the new needle holder from the narrower side.

1 Maintenance

To replace the APCI nebulizer needle

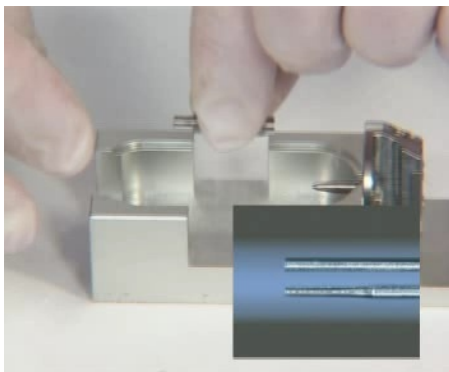

Figure 30 Sliding the non-tapered end of the needle through the new needle holder

- 7 Push a new ferrule, flat-side first, onto the needle.
- 8 Be sure the needle does not extend from the ferrule.
- 9 Reinstall the locknut and the union. Hand tighten the union.
- 10 Hold the needle holder steady with a 3-mm wrench and tighten the union one-quarter to one-half turn to compress the ferrule.

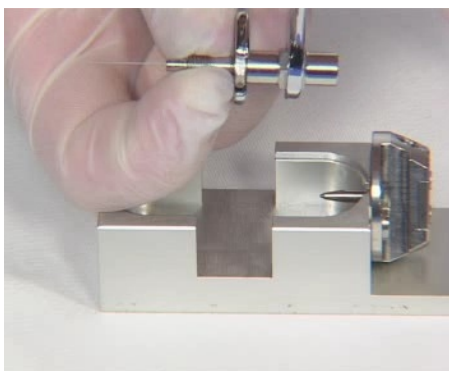

Figure 31 Tightening the union to compress the ferrule

- 11 Tighten the locknut against the union.
- 12 Pull carefully on the needle to ensure the needle is held firmly in place.
- 13 Replace locknut and washer.
- 14 Insert the needle into the nebulizer shaft.

CAUTION

Take care when inserting the needle. The tapered end of the needle must pass through restrictions in the nebulizer shaft. The tip of the needle can be damaged if excessive force is applied.

15 Adjust the APCI needle position before reinstalling the nebulizer in the spray chamber.

NOTE

Record this procedure in the Maintenance Logbook.

1 Maintenance

To adjust the APCI nebulizer needle

To adjust the APCI nebulizer needle

When required After replacing the APCI nebulizer needle or if symptoms indicate the needle may not be correctly adjusted.

Tools required

- Adjustment fixture (p/n G1946-20215)
- Gloves, clean
- Magnifier (p/n G1946-80049)
- Wrench 3-mm, open-end (p/n 8710-2699)
- Wrench ¼-inch x 5/16-inch, 2 required (p/n 8710-0510)

Parts required None

1 Install the nebulizer in the adjustment fixture.



Figure 32 Installing the nebulizer in the adjustment fixture

- 2 Loosen the needle holder locknut.
- 3 Position the magnifier so you can view the tip of the nebulizer.
- 4 Adjust the needle holder until the needle is even with the tip of the nebulizer.

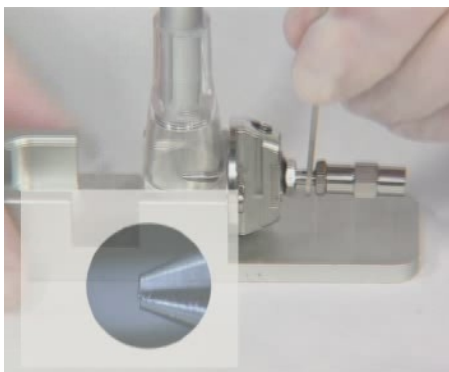

Figure 33 Adjusting the needle holder

- 5** Tighten the locknut. Make sure this does not change the position of the needle.
- 6** Remove the nebulizer from the adjustment fixture and reinstall it in the APCI spray chamber.
- 7** Be very careful not to hit the tip of the nebulizer against anything. Any damage will have a large, negative effect on system performance.

NOTE

Record this procedure in the Maintenance Logbook.

1 Maintenance

To reinstall the APCI nebulizer

To reinstall the APCI nebulizer

When required As necessary.

Tools required None

Parts required None

- 1 Insert the nebulizer into the spray chamber.
- 2 Turn it clockwise to lock it into place.
- 3 Reconnect the nebulizing gas tubing to the nebulizer.
- 4 Reconnect the LC tubing to the zero-dead-volume union.
- 5 Do not overtighten the LC fitting. Overtightening the fitting can crush the tubing, creating a restriction.

To clean the corona needle

When required When you observe decrease sensitivity, decreased signal stability, and increase corona voltage during APCI operation.

- Tools required**
- Abrasive paper, 8000 grit (p/n 8660-0852)
 - Cloths, clean, lint-free (p/n 05980-60051)
 - Gloves, clean
 - Isopropanol, reagent grade or better

Parts required None

- 1 Pull the corona needle assembly out of the spray chamber.

WARNING

The needle and related parts get very hot during operation. Make sure they have cooled before proceeding.

- 2 Fold a piece of abrasive paper over the base of the needle.
- 3 Pull and twist the abrasive paper along the needle and off the tip of the needle.

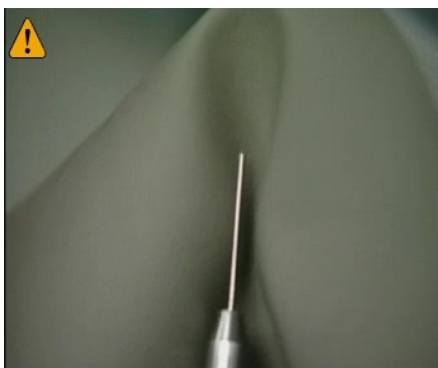

Figure 34 Pulling and twisting abrasive paper along the tip of the needle

CAUTION

Do not bend or blunt the tip of the needle, or it will decrease system performance. Sharpening the needle is not necessary.

1 Maintenance

To clean the corona needle

- 4 Repeat steps 2 and 3 several times.
- 5 Starting at the base of the needle, wipe the needle with a clean cloth. The cloth can be dry or dampened with isopropanol.
- 6 Reinstall the corona needle assembly in the spray chamber.

CAUTION

Do not hit the tip of the needle against anything. It will bend the tip which will decrease system performance.

NOTE

If this procedure fails to restore system performance, replace the corona needle.

To replace the corona needle

CAUTION

Do not hit the tip of the needle against anything. It will bend the tip which will decrease system performance.

If this procedure fails to restore system performance, replace the corona needle.

When required When symptoms indicate poor corona needle performance and cleaning the needle does not restore performance.

Tools required

- Cloths, clean, lint-free (p/n 05980-60051)
- Gloves, clean
- Isopropanol, reagent grade or better

Parts required Corona needle (p/n G1947-20029)

1 Pull the corona needle assembly out of the spray chamber.

WARNING

The needle and related parts get very hot during operation. Make sure they have cooled before proceeding.

2 Remove the needle collar.

3 Remove the old corona needle from the collar.

4 Install a new needle, with its integral ferrule, in the collar.

1 Maintenance

To replace the corona needle



Figure 35 Installing a new needle into the collar

- 5 Turn the collar onto the needle holder and tighten by hand.
- 6 Reinstall the corona needle assembly in the spray chamber.

CAUTION

Do not hit the tip of the needle against anything. It will bend the tip which will decrease system performance.

NOTE

Record this procedure in the Maintenance Logbook in the Diagnosis view of the system software.

Multimode Source

This section describes how to clean the multimode source.

To open the multimode source



When required To access the end cap and capillary cap for cleaning and inspection

Tools required Gloves, clean

Parts required None

WARNING

Do not touch the multimode source or the capillary cap. They may be very hot. Allow the multimode source to cool down before you handle them.

1 Maintenance

To open the multimode source

WARNING

Never touch the source surface, especially when you analyze toxic substances or when you use toxic solvents. The source has several sharp pieces, including the APCI corona needle, vaporizer sensor and counter current electrode, which can pierce your skin.

WARNING

Do not insert fingers or tools through the openings on the Multimode chamber. When in use, the capillary and capillary cap are at high voltages up to 4 KV.

- 1 Open the spray chamber cover by pulling the latch.

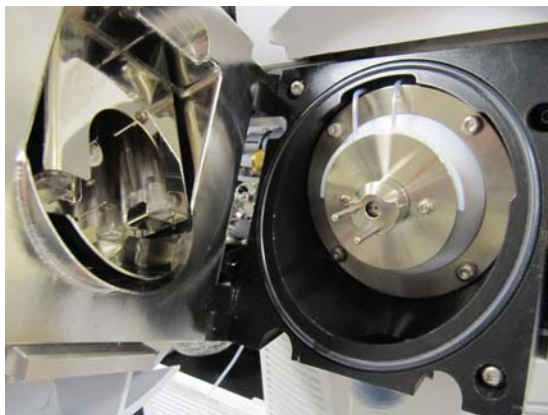

Figure 36 Opened multimode source

- 2 Check that the vaporizer temperature sensor is straight and extends 15 mm from back of chamber.
- 3 Check that the separator is aligned vertically.
- 4 Check that the APCI corona needle is in and extends approximately 3 mm.
- 5 Check that the source is cleaned.
- 6 Close and latch the multimode source

NOTE

When the multimode source is open, the LC/MS quad high voltage and vaporizer will be shut off. The Method Control View will show the LC/MS quad and the LC is in shutdown mode and is in Red. If a new capillary was installed, record this in the Maintenance Logbook in the Diagnosis view of the system software.

1 Maintenance

To clean the multimode source daily

To clean the multimode source daily

When required Daily or anytime you suspect carryover contamination from one sample or analysis to another, or when you must access the end cap and capillary cap for cleaning and inspection.

Tools required

- Gloves
- Wash bottle, clean

Parts required

- Abrasive paper, 8000 grit (p/n 8660-0852)
- Cloths, clean, lint-free (p/n 05980-60051)
- Cotton swabs (p/n 5080-5400)
- Mobile phase from the current method *or* clean isopropanol, reagent grade or better
- Water, reagent-grade or better

1 Turn off the spray chamber, nebulizer pressure, drying gas flow, drying gas temp, and vaporizer temp.

WARNING

Do not touch the multimode source or the capillary cap. They may be very hot. Allow the multimode source to cool down before you handle them.

-
- 2 Remove the nebulizer and the APCI corona needle.
 - 3 Remove the cosmetic cover. You will have to remove the thermocouple probe before you can wipe the spray chamber. Otherwise, leave the thermocouple intact.
 - 4 Open the spray chamber.
 - 5 Rinse the interior of the spray chamber using the wash bottle filled with the current mobile phase or with a mixture of isopropanol and water.

NOTE

Recent residue should be soluble in the mobile phase. If you are not sure what mobile phase was used recently, a solution of 50% isopropanol and 50% water works well as a general cleaning solution.

WARNING

Some mobile phase are hazardous chemicals. Use the degree of caution appropriate for the mobile phase being used.

6 Wipe the interior of the spray chamber with a clean, lint-free cloth.

WARNING

Sharp edges can be found inside the spray chamber, such as the separator. Pay close attention when wiping the interior of the spray chamber.

7 Rinse the area around the spray shield. Do not spray directly toward the tip of the capillary. This can cause pressure surges in the vacuum system.

8 Dampen a clean cloth with the mobile phase. Wipe the spray shield, field shaping electrodes and the area around the spray shield.

9 Replace the nebulizer and the APCI corona needle.

10 Install the thermocouple probe and adjust it so that it protrudes 15 mm from the inner spray chamber wall.

11 Replace the cosmetic cover.

12 Close the spray chamber.

NOTE

Use the weekly cleaning process if symptoms of contamination persist, or if the spray shield or capillary cap show significant discoloration that can not be removed by the normal daily cleaning procedure.

1 Maintenance

To clean the multimode source weekly

To clean the multimode source weekly

The cleaning procedure for cleaning the multimode source weekly is similar to the daily procedure. The main difference is that the multimode source is removed from the instrument in the weekly procedure.

When required Weekly if the normal daily cleaning procedure is not sufficient

Tools required

- Gloves
- Wash bottle, clean

Parts required

- Abrasive paper, 4000 grit (p/n 8660-0827)
- Cloths, clean, lint-free (p/n 05980-60051)
- Cotton swabs (p/n 5080-5400)
- Mobile phase from the current method *or* clean isopropanol, reagent grade or better
- Water, reagent-grade or better

- 1 Remove the multimode source.
- 2 Fill the spray chamber with clean mobile phase, or with a mixture of isopropanol and water.

NOTE

Recent residue should be soluble in the mobile phase. If you are not sure what mobile phase was used recently, a solution of 50% isopropanol and 50% water works well as a general cleaning solution.

WARNING

Some mobile phase are hazardous chemicals. Use the degree of caution appropriate for the mobile phase being used.

- 3 Scrub the corona insulator and the interior of the spray chamber with a clean cotton swab.
- 4 Empty the spray chamber.
- 5 Wipe the interior of the spray chamber with a clean, lint-free cloth

WARNING

Sharp edges can be found inside the spray chamber, such as the separator. Be careful when wiping the interior of the spray chamber.

- 6** Remove the spray shield. Use abrasive paper to gently clean the end of the capillary cap.
- 7** Dampen a clean cloth and wipe the end of the capillary cap.
- 8** Reinstall the spray chamber.
- 9** Use abrasive paper to gently clean the spray shield. Dampen a clean cloth and wipe the spray shield.
- 10** Rinse the area around the spray shield then wipe the area around the spray shield.
- 11** Reinstall the spray chamber on the instrument.
- 12** Replace the nebulizer and APCI corona needle.
- 13** Install the thermocouple probe and adjust it so that it protrudes 15mm from the inner spray chamber wall.
- 14** Replace the cosmetic cover.
- 15** Close the spray chamber.

Ion Transfer Capillary

This section describes the steps to remove, clean and reinstall the ion transfer capillary.

To remove the capillary

When required	When you need to clean or replace the capillary.
Tools required	Gloves, clean
Parts required	None

- 1 Vent the system.
- 2 Unplug the instrument power cord from the power outlet after venting is complete.
- 3 Open the spray chamber.

WARNING

The spray chamber operates at very high temperatures. Give the spray chamber time to cool before proceeding.

- 4 Remove the spray shield.
- 5 Remove the capillary cap from the end of the capillary.
- 6 Carefully pull the capillary out of the desolvation assembly.



Figure 37 Pulling the capillary out of the desolvation assembly

CAUTION

Carefully pull the capillary out along its long axis. The capillary is glass or of similar material, and you can break it by putting vertical or horizontal pressure on it.

1 Maintenance

To clean the capillary

To clean the capillary

When required When you observe decreased sensitivity and decreased signal stability

Tools required

- 5190-1401 Cleaning Powder, Dielectric Capillary
- 100mL polypropylene graduated cylinder, or glass-graduated cylinder with two 1 mL pipette tip

Parts required Powdered Precision Cleaner (Alconox catalog number 1104)

- 1 Dissolve 1 g Alconox Powdered Precision Cleaner in 100 mL deionized water.

This concentration is the recommended concentration for “manual or ultrasonic cleaning”.

- 2 Place the ion transport capillary upright in a 100 mL polypropylene graduated cylinder and fill with Alconox solution.
- 3 Sonicate the graduated cylinder with the ion transport capillary in an ultrasonic cleaner for 10 to 15 minutes.



You may use a 1 mL pipette over the end of the ion transport capillary to protect the metallized plating. Trim the pipette tip to approximately 4 cm so that the capillary can be immersed in the cleaning solution.



To maintain proper cleanliness, handle the ion transport capillaries with protective gloves.

- 4 Rinse the ion transport capillary and graduated cylinder several times with deionized water.
- 5 Fill the graduated cylinder with deionized water and sonicate the graduated cylinder with the ion transport capillary for 10 to 15 minutes.
- 6 Remove the ion transport capillary from the graduated cylinder and remove the pipette tip (if one was used).
- 7 Blow out excess water from the ion transport capillary bore using AeroDuster or oil-free pressurized gas.
- 8 Install the ion transport capillary in LC/MS Desolvation Assembly:
 - a Lubricate the ion transport capillary surface with isopropanol and insert carefully into Desolvation Assembly. Support the front and rear of the capillary and keep it level during installation.

When 2 to 3 cm of the capillary remains extended from the Desolvation Assembly, the capillary will “hold up” on the rear contact spring. Continue to apply pressure until approximately 1 cm remains extended from the Desolvation Assembly.

- b Lubricate the ion transport capillary tip with isopropanol and install the Capillary Cap.
- c Install the threaded Spray Shield by turning clockwise.

1 Maintenance

To clean the capillary

- 9 Close the spray chamber and begin an instrument pump down using the “Maintenance\MSD Pumpdown” function.

The 6100 series LC/MS instruments require a power cycle to initiate the pumpdown function.

NOTE

Record this procedure in the Maintenance Logbook in the Diagnosis view of the system software.

To reinstall the capillary

When required After cleaning the capillary or when installing a new capillary.

Tools required Gloves, clean

Parts required Isopropanol, HPLC grade or better

- 1 Lubricate the capillary entrance end with isopropanol.
- 2 Slide the capillary straight into the desolvation assembly. The capillary must be aligned correctly so that its end will fit into a fixed capillary cap inside the desolvation assembly.



Figure 38 Reinstalling the capillary

CAUTION

Putting vertical or horizontal pressure on the capillary can break it.

- 3 Reinstall the capillary cap over the outer end of the capillary.
- 4 Reinstall the spray shield.
- 5 Close the spray chamber.

NOTE

If a new capillary was installed, record this procedure in the Maintenance Logbook in the Diagnosis view of the system software.

Desolvation Assembly

This section describes how to maintain the desolvation assembly.

To remove the desolvation assembly

When required	When you need to access the optics assembly
Tools required	<ul style="list-style-type: none">• Wrench, ½-inch x 9/16-inch, open-end (p/n 8710-0877)• Screwdriver, TORX, T-20 (p/n 8710-1615)
Parts required	None

WARNING

The spray chamber and desolvation assembly operate at very high temperatures. Give them time to cool before proceeding.

- 1 Vent the system.
- 2 Turn off the power switch.
- 3 Unplug the instrument power cord from the power outlet after venting is complete.
- 4 Disconnect the drain hose from the desolvation assembly.
- 5 Remove the front covers.
- 6 Disconnect the drying gas tubing from the desolvation assembly.
- 7 Disconnect the drying gas heater cable from the desolvation assembly.
- 8 Disconnect the spray chamber high voltage cable from the desolvation assembly.
- 9 Fully loosen the captured retaining screw at the top of the desolvation assembly.
- 10 Remove the two retaining screws that keep the desolvation assembly attached to the support rods.

To remove the desolvation assembly

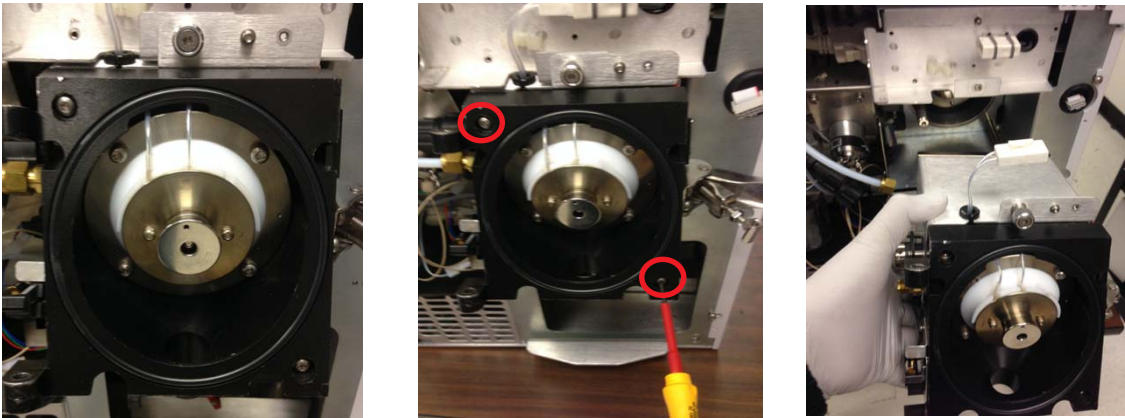

Figure 39 Removing the desolvation assembly. Remove the screws that are circled in the center image.

11 Slide the desolvation assembly off of the support rods.

NOTE

The capillary column is contained in the desolvation assembly. It does not need to be removed in order to remove the desolvation assembly.

1 Maintenance

To clean skimmer 1

To clean skimmer 1

When required When symptoms indicate it is necessary.

Tools required

- Cloth, clean, lint-free (p/n 05980-60051)
- Gloves, clean
- Isopropanol, reagent grade or better
- Water, reagent-grade or better

Parts required None

- 1 Remove the desolvation assembly.
- 2 Dampen a clean cloth with a mixture of Isopropanol and water.

CAUTION

The tip of the skimmer is delicate. Do not damage it.

- 3 Wipe the skimmer.

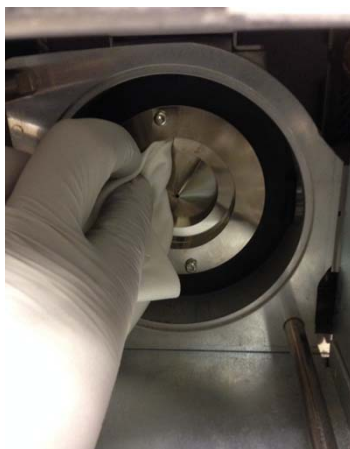

Figure 40 Wipe the skimmer.

- 4 Reinstall the desolvation assembly.

To reinstall the desolvation assembly

When required As necessary

Tools required

- Wrench, ½-inch x 9/16-inch, open-end (p/n 8710-0877)
- Screwdriver, TORX, T-20 (p/n 8710-1615)

Parts required None

- 1 Put the desolvation assembly on the support rods and slide it back until it seals against the vacuum manifold.
- 2 Install the two retaining screws.
- 3 Fully tighten the captured retaining screw at the top of the desolvation assembly.
- 4 Reconnect the drain hose to the desolvation assembly.
- 5 Reconnect the spray chamber high voltage cable to the desolvation assembly.
- 6 Reconnect the drying gas heater cable to the desolvation assembly.
- 7 Reconnect the nebulizing gas tubing to the desolvation assembly.

Calibrant Delivery System and Divert Valve

This section describes maintenance tasks that are related to the calibrant delivery system and divert valve.

When you do maintenance procedures on the divert valve:

- Do not bend any capillary line.
- The position of the divert valve can be set only in the On mode.
- Put the instrument in the Off mode.
- Remove the covers before you begin.
- Install the covers of the instrument after you finish.

Table 1 Divert Valve Connection (see [Figure 41](#))

No.	Port	Connection	User action
1	Inlet	from the front inlet union behind the inlet cover	none
2	Inlet	from CDS	none (permanent connection from calibrant delivery system)
3	Outlet	to the ion source	connect the flexible capillary to the ion source
4	Loop	loop to port 6	none (permanent connection)
5	Waste	to the drain bottle	none
6	Loop	loop to port 4	none (permanent connected)

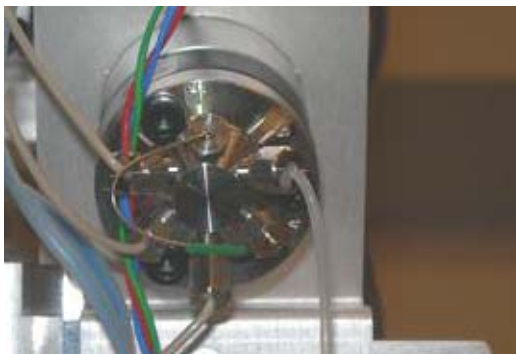

Figure 41 Divert valve with port position indicators

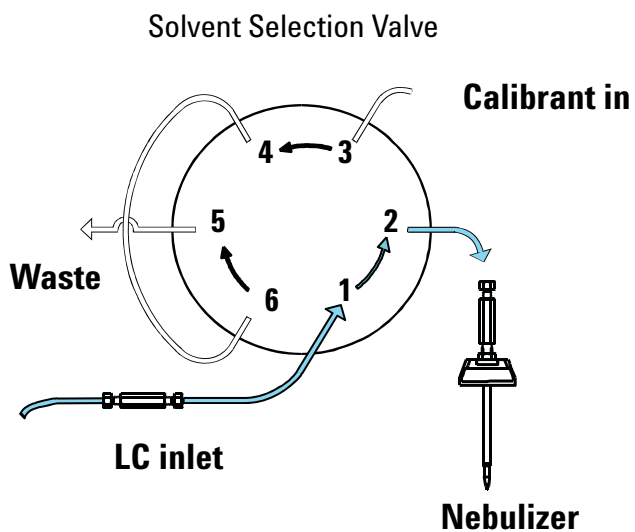

Figure 42 LC to LC/MS flow

1 Maintenance
Calibrant Delivery System and Divert Valve

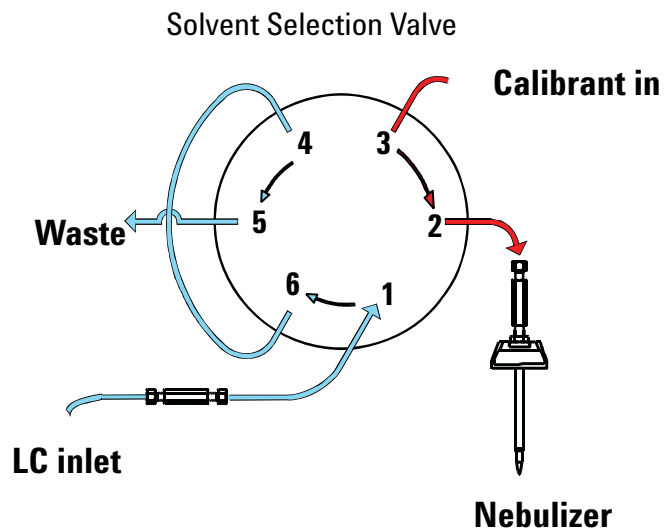

Figure 43 Calibrant to LC/MS flow

To check calibrant levels

When required Monthly or weekly if you tune the instrument frequently

Tools required None

Parts required None

- 1 Examine each calibrant bottle. Enough tuning mix must be present to immerse the end of the intake tube.

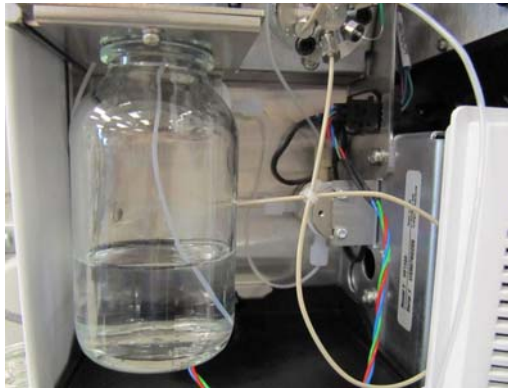

Figure 44 Calibrant bottle level

- 2 If the tuning mix level is within a few millimeters of the end of the intake tube, refill the calibrant bottle.

NOTE

Record this procedure in the Maintenance Logbook in the Diagnosis view of the system software.

Make sure to use the correct calibrant for designated source.

1 Maintenance

To fill a calibrant bottle

To fill a calibrant bottle

When required As necessary.

Tools required None

Parts required

Table 2

Model	Source	Calibrant
6120, 6130	ESI	ESI Tuning Mix (p/n G2421)
6120, 6130	APCI, APPI, MM	APCI/APPI Calibrant Solution (p/n G2432A)
6150	ESI, MM	ESI-L Tuning Mix (p/n G1969-85000)
6150	APCI	APCI-TOF Tune Mix (p/n G1969-85010)
6150	APPI	APCI/APPI Calibrant Solution (p/n G2432A)
6150	ESI with Agilent Jet Stream Technology	ESI-L Tuning Mix (p/n G1969-85000)

- 1 Turn the bottle to be refilled clockwise until it can be removed from the fixed bottle cap.
- 2 Refill the bottle with the appropriate tuning mix.

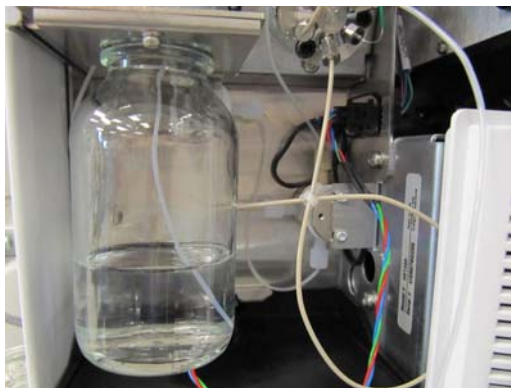

Figure 45 Calibrant bottle for tuning mix

- 3 Put the intake tube into the refilled bottle as you lift the bottle into position.

CAUTION

Tighten the bottle by hand. Do not overtighten it. The bottle only needs to be snug.

- 4 Attach the calibrant bottle onto the fixed bottle cap. Turn the bottle counterclockwise to tighten.
- 5 Select **Flush Calibrant System** from the **Instrument** menu in the Tune view.
- 6 Wait until the flush is completed.

NOTE

Record this procedure in the Maintenance Logbook in the Diagnosis view of the system software.

1 Maintenance

To flush the calibrant delivery system

To flush the calibrant delivery system

When required When symptoms indicate contamination in the calibrant delivery system (CDS). Especially when the contamination appears during tuning but not during data acquisition.

Tools required

- Acetonitrile, HPLC-grade or better
- Water, HPLC-grade or better

Parts required None

- 1 Remove the calibrant bottle exhibiting contamination.
- 2 Install a calibrant bottle containing the 90%/10% solution of acetonitrile and water.
- 3 Select **Flush calibrant system** from the **Instrument** menu in the MSD tune view.
- 4 Select the CDS channel to be flushed.
- 5 Specify a flush time of 10 minutes and click **OK**.
- 6 Wait while the calibrant delivery system pumps the mixture of acetonitrile and water through the system. After 10 minutes the CDS will stop pumping.
- 7 Remove the bottle of acetonitrile and water.
- 8 Install a new bottle of calibrant depending on which source will be used.

CAUTION

Do not reinstall the old bottle of calibrant. The old calibrant may be the source of the contamination.

- 9 Flush this channel of the CDS for 5 minutes with the new calibrant.

NOTE

Record this procedure in the Maintenance Logbook in the Diagnosis view of the system software.

To check for leaks

When required When the sensor indicates a leak has occurred.

Tools required

- Cloths, clean, lint-free (p/n 05980-60051)
- Cotton swabs (p/n 5080-5400)

Parts required None

WARNING

The spray chamber operates at very high temperatures. Do not touch any parts inside the chamber until they have had time to cool.

- 1 Remove the cover of the calibrant delivery system.
- 2 Check the catch tray. If you see liquid, there is a leak. If no liquid is present, the leak sensor may be out of calibration. See the online Help for instructions to calibrate the leak sensor.
- 3 If a leak occurs during a long unattended run, the liquid from the leak may evaporate to give you the impression that no leak exists and the leak sensor is out of calibration. Turn the system back on and make sure no leak exists before you recalibrate the leak sensor.
- 4 Check the selection valve, the waste fitting, the inlet fitting, and the calibrant delivery system valves. If you find a leak, correct it and check the remaining locations.

1 Maintenance
To check for leaks

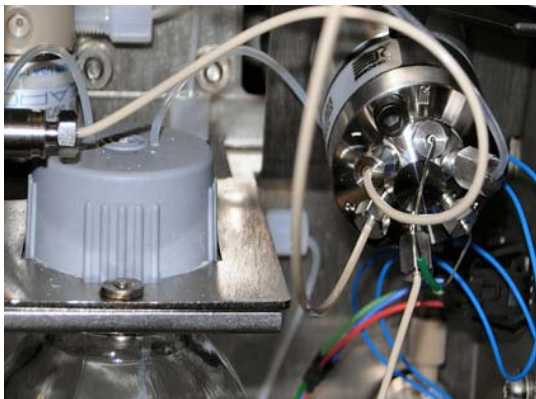

Figure 46

- 5** Dry the catch tray and leak sensor.
- 6** When the catch tray and leak sensor are thoroughly dry, reassemble the instrument.

To replace the LC filter elements

When required When back pressure is high on the LC pump or when the sensor indicates a leak has occurred.

Tools required

- Tweezers
- Wrench, ½-inch

Parts required Filter Element, 5 µm (p/n 0100-2051)

- 1 Stop the flow of LC solvent to the instrument.
- 2 Remove the cover from the calibrant delivery system.

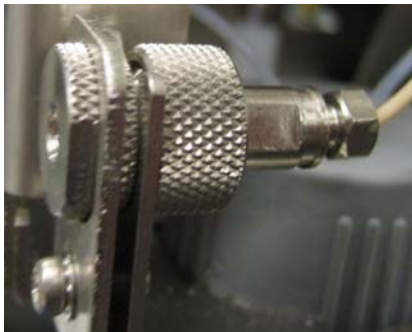

Figure 47 Inlet filter assembly

- 3 Remove the retaining screw at the top of the inlet filter assembly and pull the filter assembly forward out of the bracket.
- 4 While holding the knurled lower part of the assembly, twist the upper part counterclockwise until the two parts are separated.
- 5 Use tweezers to remove the filter element from the upper part of the assembly. The filter element is a stainless steel frit surrounded by a PTFE ring.
- 6 Insert the new filter element.
- 7 Reassemble the filter assembly.
- 8 Reinsert the assembly into the bracket and reinstall the top retaining screw.
- 9 Reinstall the cover.

1 Maintenance

To replace the MS selection valve rotor seal

To replace the MS selection valve rotor seal

- When required** Approximately annually or when no calibrant flow exists during tuning, or when the back pressure is high on the LC pump during acquisition.
- Tools required** 9/64-inch Hex key (p/n 8710-2394)
- Parts required** Rotor seal (p/n 0100-1855)

- 1 Stop the flow of LC solvent to the instrument.
- 2 Remove the cover from the calibrant delivery system.
- 3 Make a note of which port is plumbed to which tubing.
- 4 Remove the tubing connections from the six-port MS selection valve.
- 5 Use the hex key to remove the three hex head screws from the stator face of the selection valve.
- 6 Remove the rotor seal and replace it with a new one. Be sure to install it in the proper orientation.



Figure 48 CDS rotor valve in its proper orientation

- 7 Reinstall the stator face assembly.
- 8 Reconnect the tubing to the selection valve.
- 9 Reinstall the left, top and front covers.

Analyzer and Ion Optics Assembly

This section describes the maintenance steps for the analyzer and ion optics assembly.

To open the analyzer

When required	As necessary for maintenance.
Tools required	None
Parts required	None

- 1 Vent the system.
- 2 Unplug the instrument power cord from the power outlet after venting is complete.
- 3 Remove the front cover from the instrument.
- 4 Remove the top cover from the instrument.
- 5 Put on an antistatic wrist strap. Attach the wrist strap to a grounded surface such as the back panel of the instrument.
- 6 Disconnect the connections to the Aux module, and lift off and remove the Aux module.
- 7 Lift off the vacuum manifold cover.

1 Maintenance

To replace the electron multiplier horn

To replace the electron multiplier horn

- When required** When sensitivity is poor and autotune consistently sets the detector gain to its maximum value
- Tools required**
- Gloves, clean
 - Pliers, long-nose (p/n 8710-0004)
- Parts required** EM replacement horn (p/n 05971-80103)



Figure 49

- 1 Disconnect the signal wire from the electron multiplier horn.
- 2 Open the retaining clip.
- 3 Remove the electron multiplier horn.
- 4 Install a new electron multiplier horn.
- 5 Close the retaining clip.
- 6 Connect the signal wire to the pin on the electron multiplier horn.
- 7 Close the analyzer.

NOTE

Record this procedure in the Maintenance Logbook.

To clean the high energy dynode

When required When sensitivity is poor and autotune consistently sets the detector gain to its maximum value

- Tools required**
- Beakers, large (2 required, at least 500 mL each)
 - Gloves, clean
 - Hex wrench, 0.8mm (p/n 8710-1225)
 - Isopropanol, reagent grade or better
 - Pliers, long-nose (p/n 8710-0004)
 - Screwdriver, TORX, T-20 (p/n 8710-1615)

Parts required None

- 1 Disconnect the two braided wires from the electron multiplier.
- 2 Remove the two screws that hold the electron multiplier to the vacuum manifold.

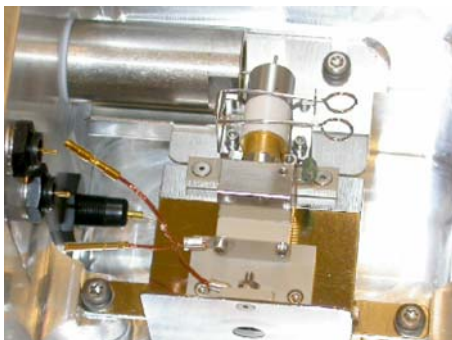

Figure 50 Electron multiplier exposed

- 3 Remove the electron multiplier and, at the same time, carefully disconnect the two remaining rigid wires.
- 4 Remove the electron multiplier horn from the electron multiplier.

CAUTION

The solvents used in the cleaning process will damage the electron multiplier horn.

1 Maintenance

To clean the high energy dynode

- 5 Loosen the two small set screws that hold the resistor in place. Remove the resistor.

CAUTION

The solvents used in the cleaning process will damage the resistor.

- 6 Place the electron multiplier (without the horn or resistor) into a beaker containing 200 mL of isopropanol. Make sure the high energy dynode is immersed.
- 7 Gently agitate the beaker by hand for 1 minute.

CAUTION

Do not use an ultrasonic bath. It could loosen screws or disrupt the precise alignment of electron multiplier components.

- 8 Transfer the electron multiplier to another beaker containing about 200 mL of methanol. Make sure the high energy dynode is immersed.
- 9 Gently agitate the beaker by hand for 1 minute. This helps to rinse off the isopropanol.

CAUTION

Do not use an ultrasonic bath. It could loosen screws or disrupt the precise alignment of electron multiplier components.

- 10 Remove the electron multiplier and allow it to dry. The methanol will dry quickly. Do not bake the electron multiplier or otherwise try to speed the drying process.
- 11 Reinstall the resistor and electron multiplier horn.
- 12 Reinstall the electron multiplier in the vacuum manifold and, at the same time, connect the two rigid wires to the electron multiplier.
- 13 Install and tighten the two screws that hold the electron multiplier in place. Reconnect the two braided wires to the electron multiplier.

To close the analyzer

When required As necessary after analyzer maintenance.

Tools required None

Parts required None

NOTE

If you worked on any components in the analyzer, check to be sure the electrical connections are correct before closing the analyzer.

- 1 Position the manifold cover on the vacuum manifold.
- 2 Reinstall the Aux module on to the top of the vacuum manifold.
- 3 Connect all electronics cable.
- 4 Reinstall the front cover of the LC/MS.
- 5 Plug the power cord back to the system.
- 6 Pump down the LC/MS by pressing the front switch.

1 Maintenance

To clean the ion optics assembly

To clean the ion optics assembly

CAUTION

This procedure is to be done by an Agilent-trained Service Engineer only. Agilent assumes no responsibility for damages if someone other than an Agilent-trained Service Engineer attempts these steps.

When required When the system has difficulty tuning, or when the system has poor sensitivity.

Tools required

- Gloves, clean
- Cloths, clean, lint-free (p/n 05980-60051)
- Beakers, 500 mL, 2 ea
- Tweezers
- Screwdriver, TORX, T-10 (p/n 8710-1623)
- Ball driver, 1.5 mm (p/n 8710-1570)
- Methanol, reagent grade or better
- Isopropanol, reagent grade or better
- Acetone, reagent grade or better

Parts required None

- 1 Vent the system.
- 2 Remove the source.
- 3 Remove the desolvation assembly.
- 4 Remove the vacuum manifold cover.
- 5 Unplug all of the ion optics cables so that the ion optics assembly can be removed. Pay close attention to the orientation of the cables and their respective locations.
- 6 Use your finger to push on the skimmer spacer to get the ion optics to pop out of the instrument. Be careful to catch it so it doesn't fall on the floor. See [Figure 51](#).

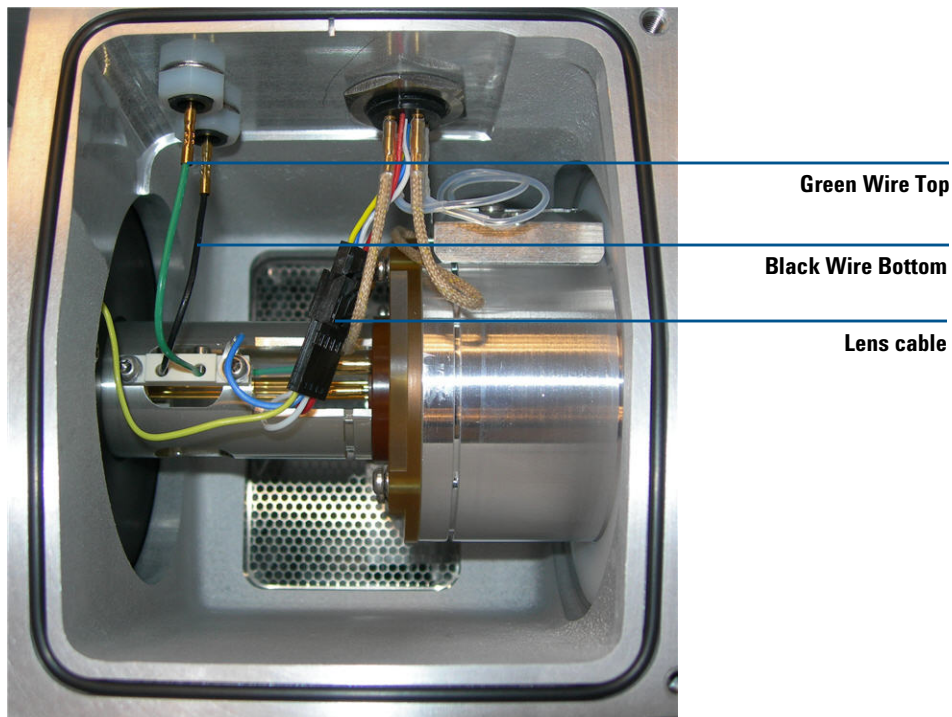

Figure 51 Optics assembly

- 7 Place the ion optics assembly on a clean cloth ([Figure 52](#)).
- 8 Reposition the assembly holding the skimmer spacer and remove the two screws that hold skimmer 1.
- 9 For 6120, after you remove skimmer 1, remove the two screws that hold skimmer 2 to the black skimmer spacer. Then remove skimmer 2.
- 10 Carefully remove skimmer 1 ([Figure 53](#)). You may need to use a flat blade screwdriver to gently pry skimmer 1 from its seat.

CAUTION

Be careful! The screwdriver blade can damage the octopole rods. If you damage the octopole rods, you must replace the entire assembly.

1 Maintenance

To clean the ion optics assembly



Figure 52 Ion optics assembly

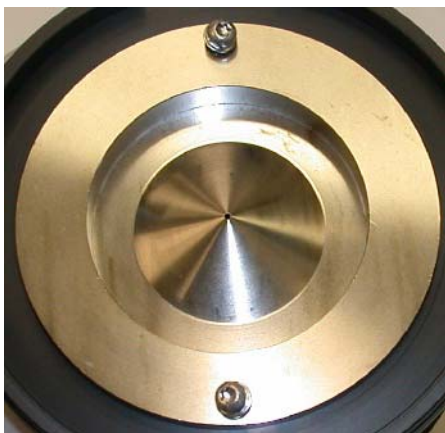

Figure 53 Skimmer 1 (detail)

- 11 Remove the two screws holding the octopole to the skimmer space (Figure 54). Be careful not to let the ion optics fall on the table. Support the octopole by holding it up by the octopole tube.



Figure 54 Octopole rods extending through Skimmer Spacer.

12 Disconnect wiring harness and connections (**Figure 55**). The lens 2 red wire and lens 1 white wire. Leave the yellow wires attached to skimmer spacer (**Figure 56**). Leave the ion optics in the skimmer spacer and use it as a stand to remove lens 2, spacer insulator, and lens 1. Be careful not to damage the octopole rods.

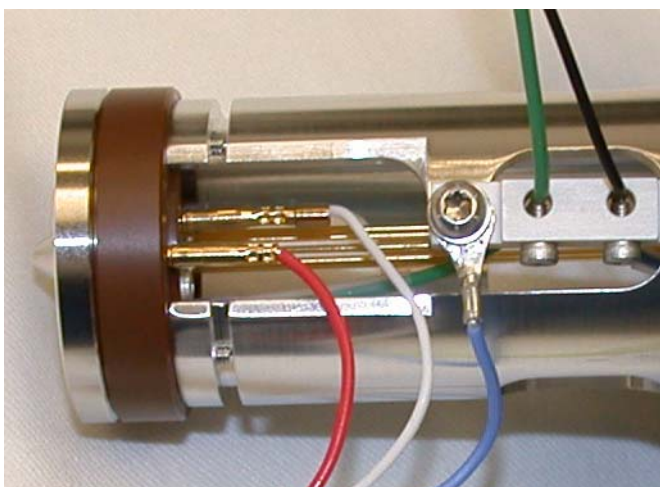

Figure 55 Lens 1 and Lens 2 wires

1 Maintenance

To clean the ion optics assembly



Figure 56 Skimmer spacer

13 Use the 1.5 mm ball driver to remove the two screws that hold Lens 2 (Figure 57). Then remove the spacer insulator (Figure 58).

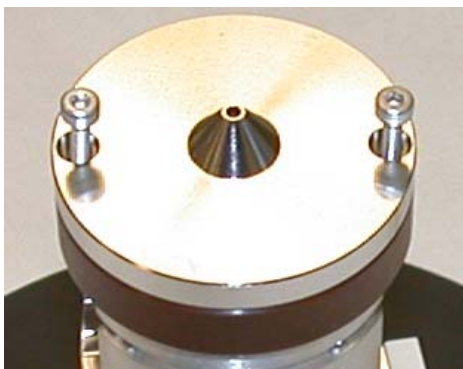

Figure 57 Lens 2

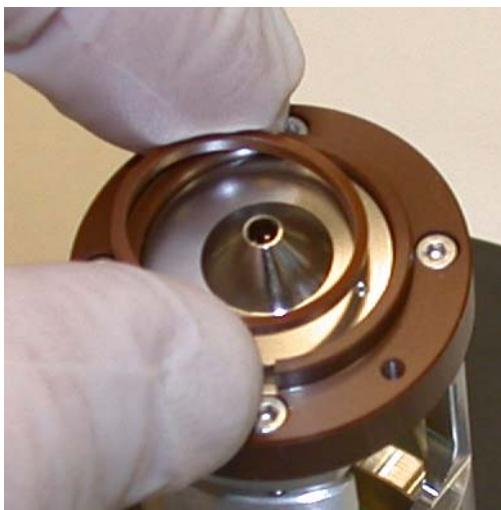

Figure 58 Spacer insulator

14 Remove Lens 1.

15 Pull the octopole out of the skimmer spacer. The octopole is now ready to be sonicated. There should be no further disassembly of the octopole.

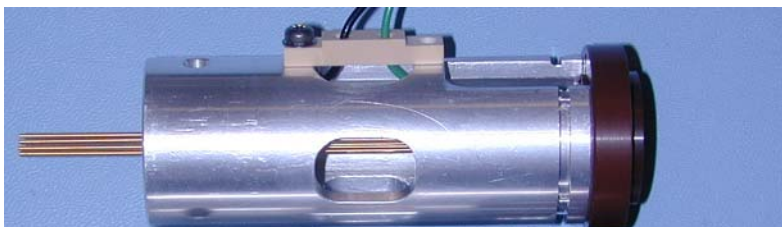

Figure 59 Octopole assembly

16 Take the entire octopole assembly and place it in a beaker of high purity isopropanol. Sonicate for 5 minutes. Pour out the isopropanol and refill the beaker with 100% acetone. Sonicate for another 5 minutes. Pour out the acetone and refill with 100% methanol. Sonicate for another 5 minutes.

17 Place Skimmer, Lens 1 and Lens 2 in a beaker of high purity isopropanol. Sonicate for 5 minutes. Pour out the isopropanol and refill

1 Maintenance

To clean the ion optics assembly

the beaker with 100% acetone. Sonicate for another 5 minutes. Pour out the acetone and refill with 100% methanol. Sonicate for another 5 minutes. The skimmers and lenses can be wiped with lint-free cloth with solvent (methanol).

CAUTION

- Do not abrasively clean the skimmer because it is plated, and abrasive cleaning will damage the plating.
- Do not expose the skimmer O-ring to these solvents.
- Do not reuse the solvents between sets of components.
- Sonicating the assembly will *not* damage the octopole or octopole wires unless you sonicate it for a long period.

-
- 18** Remove the parts from the beaker, place them on a lint-free cloth and allow them to air dry.
 - 19** Wipe the skimmer spacer completely with a lint-free cloth dampened with methanol. Make sure to wipe off any oil droplets.
 - 20** Inspect the octopole rods to make sure they are not broken. Using a small ball driver or pair of tweezers, gently touch each octopole rod on its end to make sure that it has not come detached from the connection on the end support. Do this on both ends of the octopole rods.
 - 21** Reinstall the octopole assembly into the skimmer spacer. Position the octopole assembly so that the screws on skimmer side of skimmer spacer can be installed.
 - 22** For 6120, reinstall skimmer 2.
 - 23** Reinstall skimmer 1. Don't forget the black O-ring that goes behind skimmer 1.
 - 24** Install lens 1, space insulator and lens 2. Re-attach the wiring harness. Connect all previously disconnected wires (see [Figure 52](#)).
- [Figure 60](#) and [Figure 61](#) show the exploded view of the ion optics assembly.

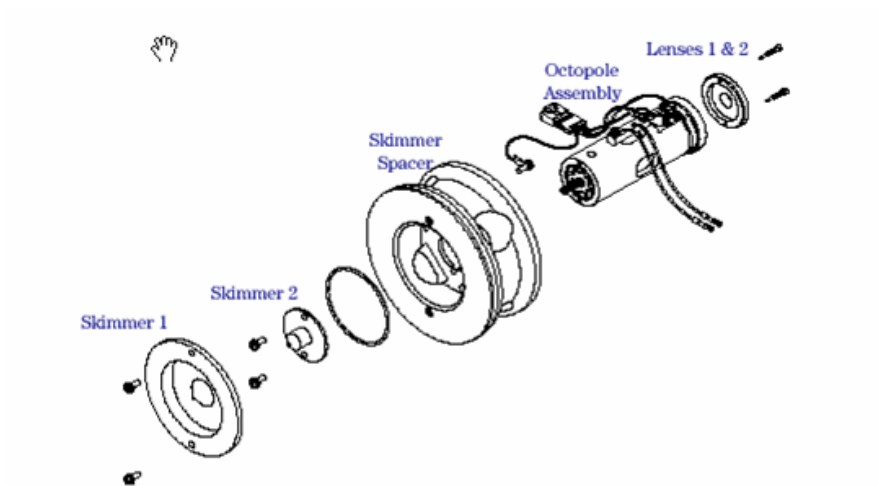

Figure 60 An exploded view of the ion optics assembly for instruments with skimmer 2 (6120).

- Single skimmer design
- Longer octopole
- Lens 1&2 Unchanged

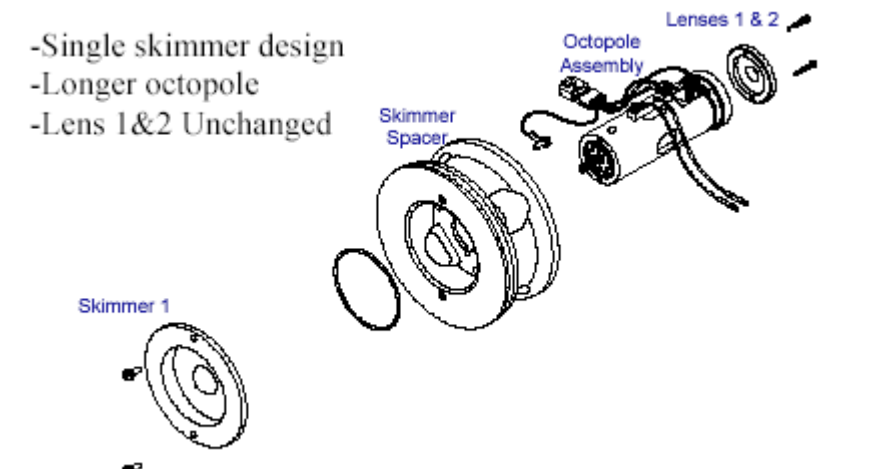

Figure 61 An exploded view of the ion optics assembly for instruments without skimmer 2 (6130 or 6150)

1 Maintenance

To clean the ion optics assembly

- 25 After reassembly of the ion optics assembly (see [Figure 62](#)), reinstall the ion optics assembly into the vacuum manifold. Connect the green and black octopole leads, and reconnect the lens cable connector.



Figure 62 The re-assembled ion optics assembly

- 26 Reinstall the desolvation assembly onto the front of the vacuum manifold. Reinstall the Aux module onto the top of the vacuum manifold, and reconnect the connections to the Aux module. Reconnect the drying gas heater cable and the drying gas line to the side of the desolvation assembly.

Vacuum System

This section lists procedures to maintain the vacuum system of the instrument. They should be performed according to the maintenance schedule or as indicated by instrument symptoms.

Your system can include either the Agilent MS40+ pump or the Edwards E1M18 rough pump.

To check the rough pump fluid level (Agilent MS40+)

Check the level and color of the pump fluid weekly.

- Check the fluid level in the window of the rough pump. The fluid level should be between the marks for Max and Min (see [Figure 63](#)).
- Check that the color of the pump fluid is clear or almost clear with few suspended particles.
- If the pump fluid is dark or full of suspended particles, replace it.

1 Maintenance

To check the rough pump fluid level (Edwards E1M18)

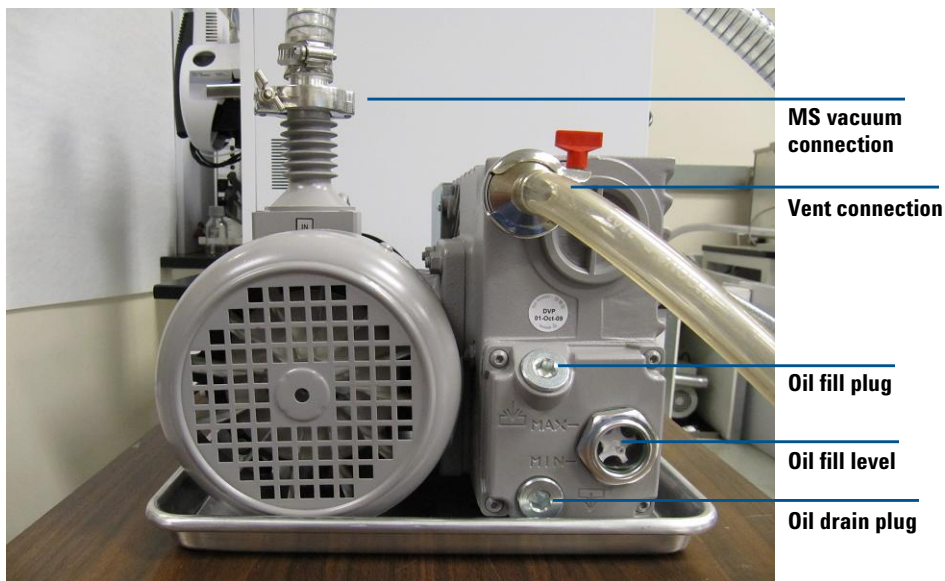

Figure 63 Fluid level window on the rough pump

To check the rough pump fluid level (Edwards E1M18)

Check the level and color of the pump fluid weekly.

- Check the fluid level in the window of the rough pump. The fluid level should be between the marks for Max and Min (see [Figure 64](#)).
- Check that the color of the pump fluid is clear or almost clear with few suspended particles.
- If the pump fluid is dark or full of suspended particles, replace it.

To check the rough pump fluid level (Edwards E1M18)

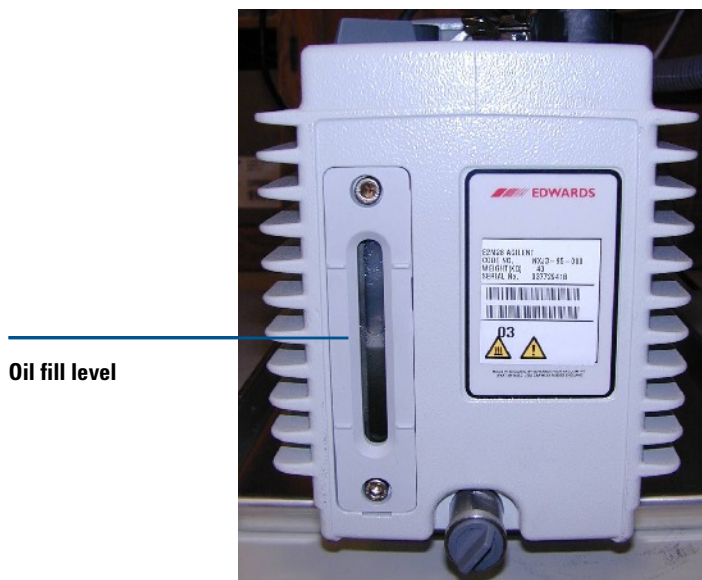

Figure 64 Fluid level window on the rough pump

CAUTION

Never add or replace the rough pump fluid while the pump is on.

NOTE

Record this procedure in the Maintenance Logbook.

1 Maintenance

To check the oil mist filter (Edwards E1M18)

To check the oil mist filter (Edwards E1M18)

Check the oil mist filter **weekly**.

- Check the oil mist filter.

Check for any damage and if pump fluid has been collected in it.

- Check the oil mist filter for damage.

If the oil mist filter is damaged, replace it.

- Check whether oil has collected in the bottom of the oil mist filter.

If oil is found in the oil mist filter, open the gas ballast valve counter-clockwise just enough to return the condensed oil back to the pump.

Close the gas ballast valve clockwise.

NOTE

When you close the ballast valve, you increase the efficiency of the pump. However, you lose oil to the mist filter if you don't recycle. Check the status of your oil mist filter at least once per week to ensure that it does not fill with oil. If you lose too much oil in the rough pump, the vacuum will not be maintained, and the Single Quad LC/MS System will vent.

To add rough pump fluid

Add pump fluid when the pump fluid level is low. Before you begin, make sure you have:

- Funnel
- Gloves, chemical resistant, clean, lint free (p/n 9300-1751)
- 10-mm Hex key (for Agilent MS40+) (p/n 8710-2612)
- For Agilent MS40+: Rough pump fluid (SW60 oil, p/n 6040-1361)
- For Edwards E1M18: Rough pump fluid (Inland 45 oil, p/n 6040-0834)

CAUTION

Wear chemical-resistant gloves and safety glasses (goggles)

WARNING

Never add pump fluid while the pump is on.

WARNING

The fill cap and pump may be dangerously hot. Check that the fill cup and pump are cool before you touch them.

CAUTION

Use only the rough pump fluid appropriate for your pump (SW60 oil for Agilent MS40+, or Inland 45 oil for Edwards E1M18). Any other fluids can substantially reduce pump life and invalidates the pump warranty.

- 1 Vent and turn off the instrument.
- 2 Unplug the instrument power cord from the electrical outlet.
Leave the power cord unplugged while you do this procedure.
- 3 Remove the fill cap on the rough pump (see [Figure 65](#)).
- 4 Add new pump fluid until the fluid level is near, but not over the maximum mark beside the fluid level window (see [Figure 65](#)).
- 5 Reinstall the fill cap.

1 Maintenance

To add rough pump fluid

- 6 Wipe off all excess oil around and underneath of the pump.
- 7 Reconnect the power cord.
- 8 Start up the instrument.

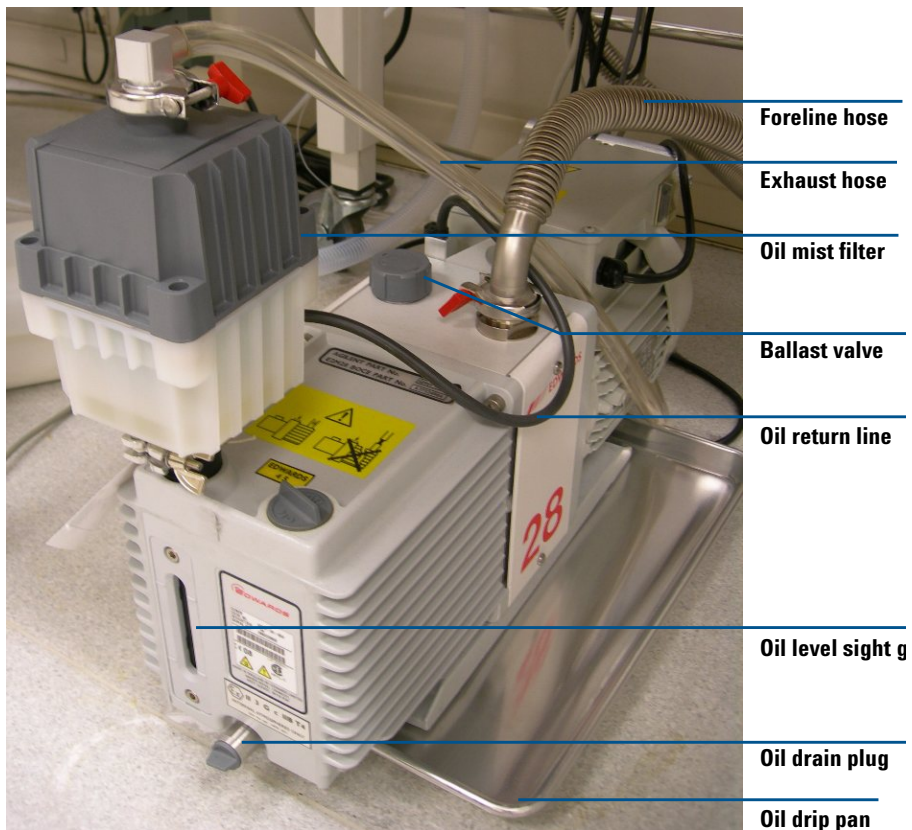

Figure 65 Rough pump (Edwards E1M18).

To replace the rough pump fluid

Replace the pump fluid every six months. Replace it sooner if the fluid appears dark or cloudy.

Before you begin, make sure you have:

- Container for catching old pump fluid
- Funnel
- Gloves, chemical resistant, clean, lint free (p/n 9300-1751)
- 10-mm Hex key (for Agilent MS40+) (p/n 8710-2612)
- For Agilent MS40+: Rough pump fluid (SW60 oil, p/n 6040-1361)
- For Edwards E1M18: Rough pump fluid (Inland 45 oil, p/n 6040-0834)
- Screwdriver, flat-bladed, large (p/n 8710-1029)

CAUTION

Wear chemical-resistant gloves and safety glasses (goggles)

WARNING

Never add pump fluid while the pump is on.

WARNING

The fill cap and pump may be dangerously hot. Check that the fill cap and pump are cool before you touch them.

WARNING

Do not touch the fluid. The residue from some samples are toxic. Properly dispose of the fluid.

CAUTION

Use only the rough pump fluid appropriate for your pump (SW60 oil for Agilent MS40+, or Inland 45 oil for Edwards E1M18). Any other fluids can substantially reduce pump life and invalidates the pump warranty.

1 Maintenance

To replace the rough pump fluid

- 1 Turn off the instrument.
- 2 Unplug the power cord from the instrument
Leave the power cord unplugged while performing this procedure.
- 3 Place a container under the drain plug of the rough pump (see [Figure 65](#) on page 100).
- 4 Remove first the fill cap (see [Figure 65](#) on page 100), then open the drain plug.
Allow the fluid to drain completely.
- 5 Reinstall the drain plug.
- 6 Pour in new pump fluid until the fluid level is near, but not above the maximum mark beside the fluid level window (see [Figure 65](#) on page 100).
- 7 Reinstall the fill cap.
- 8 Reconnect the power cord.
- 9 Start up the instrument.
- 10 After 30 minutes pump down, inspect the pump for leak.
Inspect for leak after overnight pump down.

To replace the fuses

- When required** As necessary.
- Tools required** Flat Blade Screw Driver
- Parts required**
- 8 Amp Fuse 2110-0969
 - 12 Amp Fuse 2110-1398

WARNING

Never replace the fuses with the instrument plugged into the power outlet. The instrument will immediately begin to pump down.

- 1 Unplug the instrument power cord from the power outlet.



Figure 66 Disconnect the instrument power cable.

- 2 Using a flat blade screw driver, remove the fuse holder of the blown fuse

1 Maintenance

To replace the fuses



Figure 67 AC Board fuses

- 3** Replace with the appropriate fuse. See “Replaceable Fuses” on page 109.
- 4** Reinstall the fuse holder.
- 5** Plug in the instrument.
- 6** Push the front power switch to start an automatic pump down sequence.

To bake out the LC/MS

When required The system needs to bake out when the system is on the first time or anytime system has been vented. the source should be cleaned weekly if the daily cleaning procedure does not work.

Tools required None.

Parts required None

- 1 Select the **Tune** view and then **Manual Tune**.
- 2 Display the MS Tune Spray Chamber dialog box.
- 3 Set the drying gas flow to 7 L/min.
- 4 Set the nebulizer pressure to 40 psi.
- 5 Set the drying gas temperature to 300°C.
- 6 Set the vaporizer temperature to 250°C (when applicable).
- 7 Set the LC flow to 0.5 mL/minute using the solvent mixture appropriate for your instrument models.
- 8 Make sure the position of the MS selection valve is set so that the LC flow is diverted to the spray chamber by selecting **Switch Stream > MSD**.
- 9 Allow the system to bake out for at least 2 hours.

CAUTION

If the system has been exposed to humid conditions during shipping or storage, a minimum of 4 hours bake out is required to prevent arcing of the quadrupole.

1 Maintenance
To bake out the LC/MS

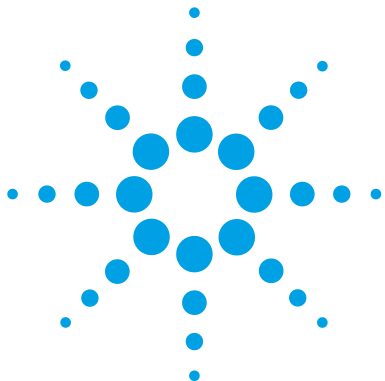

2 Reference

Safety	108
Environmental Conditions	109
Replaceable Fuses	109

This chapter contains safety and other reference information for your Agilent 6100 Series Single Quad LC/MS System.



Safety

If the 6100 Series Single Quad LC/MS is used in a manner not specified by Agilent Technologies, the protections provided by the 6100 Series Quad Single LC/MS may be impaired.



Caution,
Risk of danger,
Consult documentation



Caution,
Risk of Electric Shock



Caution,
Hot Surfaces,
Risk of Burns

Environmental Conditions

Equipment Class	Class 1 Laboratory Equipment
Pollution Degree	2
Installation Category	II
Environment	Indoor Use
Altitude	Not to exceed 2000 m
Electrical supply	200 to 240 V AC, 50/60 Hz, 2000 VA
Mains supply voltage	Fluctuations not to exceed 10% of nominal supply voltage
Operating Temperature	15 to 35°C (59 to 95°F)
Humidity	< 85% RH at 35°C

Replaceable Fuses

8 Amp, Time Delay	2110-0969
12.5 Amp, Time Delay	2110-1398

2 Reference

Replaceable Fuses

www.agilent.com

In This Book

This book contains tasks to help you maintain your Agilent 6100 Series Single Quad LC/MS System.

© Agilent Technologies, Inc.
2006-2010,2013

Printed in USA
Fourth Edition, October 2013



G1960-90154



Agilent Technologies