



Agilent 8890 Gas Chromatograph
Installation and First Startup

Notices

© Agilent Technologies, Inc. 2019

No part of this manual may be reproduced in any form or by any means (including electronic storage and retrieval or translation into a foreign language) without prior agreement and written consent from Agilent, Inc. as governed by United States and international copyright laws.

Manual Part Number

G3540-90013

Edition

Second edition, July 2019

First edition, December 2018

Printed in USA

Agilent Technologies, Inc.
2850 Centerville Road
Wilmington, DE 19808-1610 USA

安捷伦科技（上海）有限公司
上海市浦东新区外高桥保税区
英伦路412号
联系电话：（800）820 3278

Warranty

The material contained in this document is provided “as is,” and is subject to being changed, without notice, in future editions. Further, to the maximum extent permitted by applicable law, Agilent disclaims all warranties, either express or implied, with regard to this manual and any information contained herein, including but not limited to the implied warranties of merchantability and fitness for a particular purpose. Agilent shall not be liable for errors or for incidental or consequential damages in connection with the furnishing, use, or performance of this document or of any information contained herein. Should Agilent and the user have a separate written agreement with warranty terms covering the material in this document that conflict with these terms, the warranty terms in the separate agreement shall control.

Technology Licenses

The hardware and/or software described in this document are furnished under a license and may be used or copied only in accordance with the terms of such license.

Restricted Rights Legend

U.S. Government Restricted Rights. Software and technical data rights granted to the federal government include only those rights customarily provided to end user customers. Agilent provides this customary commercial license in Software and technical data pursuant to FAR 12.211 (Technical Data) and 12.212 (Computer Software) and, for the Department of Defense, DFARS 252.227-7015 (Technical Data -Commercial Items) and DFARS 227.7202-3 (Rights in Commercial Computer Software or Computer Software Documentation).

Safety Notices

CAUTION

A CAUTION notice denotes a hazard. It calls attention to an operating procedure, practice, or the like that, if not correctly performed or adhered to, could result in damage to the product or loss of important data. Do not proceed beyond a CAUTION notice until the indicated conditions are fully understood and met.

WARNING

A WARNING notice denotes a hazard. It calls attention to an operating procedure, practice, or the like that, if not correctly performed or adhered to, could result in personal injury or death. Do not proceed beyond a WARNING notice until the indicated conditions are fully understood and met.

Contents

1 Installing the GC

Overview of Installation	8
Purpose of this procedure	8
Customer responsibilities	8
About Agilent's installation service	8
Tools and additional parts required	8
Performing checkout	9
System installation	9
Configuring the GC	9
Connecting to the Browser Interface	10
The 8890 GC	11
Unpacking	12
Place the GC on the bench	13
Verify line voltage, voltage settings, and power cord	15
Line voltage	15
Power consumption	16
Power cords available	17
Grounding	21
Connect GC to LAN, Local Computer, or Tablet	22
Connect the power cord and turn on the GC	24
View the System Setup Wizard	25
Configure the GC IP address	26
Set the Date/Time	27
Set the Pressure Units	28
Configure Carrier Gas Types	29
Connect Gases and Traps	30
Install the gas regulators	30
Connect the tubing to the gas source	32
Install traps	33
Plumb to EPC flow modules	33
Install Aux EPC module frits for your application	34
Install hydrogen sensor calibration gas	36
Leak test all connections and set source pressures	38
Set source gas pressures	40

Install inlet checkout parts	41
Install ALS, if ordered	42
Configuring GC-MSD communications	43
Connect the external cables	44
Back panel connectors	44
Connecting cables	45
GC / MS / Agilent data system / ALS	47
Additional cabling configurations	47
Vent ECD or uncombusted hydrogen to a fume hood	48
Connect cryogenic cooling (if present)	49
Connecting liquid carbon dioxide	49
Connecting liquid nitrogen	50
Connecting air to the multimode inlet	51
Connect valve actuator air (if present)	53
Configure Headspace Communications	54
Configure the checkout column	55
Checkout column	55
Install the checkout column	57
Transfer the checkout sample to a screw-top sample vial	59
When the system stabilizes, run one injection	60
Prepare for the Next Analysis	61

A Making Swagelok Connections

Making Swagelok Connections	64
Using a Swagelok Tee	67

B Cabling Diagrams and Remote Start/Stop

Using the Remote Start/Stop Cable	70
Connecting Agilent products	70
Connecting non-Agilent products	70
Multi-instrument Cabling Examples	73
GC / ALS / Non-Agilent Data System	73
GC / 3395A/3396B Integrator / ALS	74
GC / 3396C Integrator / ALS	74
Example: Using a Y-Cable in a setup (GC/MSD/Data System/Headspace Sampler)	75
GC / External Events (unspecified, non-Agilent instrument)	76

Cable Diagrams	77
Analog signal cable, general use, G1530-60560	77
Agilent analog signal cable, G1530-60570	78
Remote start/stop cable, general use, 35900-60670	78
Agilent APG remote start/stop cable, 03396-61010	79
Agilent APG remote start/stop cable, G1530-60930	79
Agilent remote start/stop Y-cable, G1530-61200	80
BCD cable, G3450-60570	80
External event cable, G1530-60590	81
External valve cable, G1580-60710	82
Pulser module power supply cable, G1580-60730	82

1

Installing the GC

Overview of Installation	8
Connecting to the Browser Interface	10
The 8890 GC	11
Unpacking	12
Place the GC on the bench	13
Verify line voltage, voltage settings, and power cord	15
Connect GC to LAN, Local Computer, or Tablet	22
Connect the power cord and turn on the GC	24
View the System Setup Wizard	25
Configure the GC IP address	26
Set the Date/Time	27
Set the Pressure Units	28
Configure Carrier Gas Types	29
Connect Gases and Traps	30
Leak test all connections and set source pressures	38
Install ALS, if ordered	42
Connect the external cables	44
Vent ECD or uncombusted hydrogen to a fume hood	48
Connect cryogenic cooling (if present)	49
Configure the checkout column	55
Install the checkout column	57
Transfer the checkout sample to a screw-top sample vial	59
When the system stabilizes, run one injection	60
Prepare for the Next Analysis	61

This section contains installation procedures for the Agilent 8890 GC. Depending on the ordered options, some steps are optional, such as “plumbing” cryogenic cooling or valve actuator air.

Instructions for connecting cables from the GC to other instruments in a typical 8890 Series system are included here and in **Appendix B, “Cabling Diagrams and Remote Start/Stop”** on page 69”.

Overview of Installation

Purpose of this procedure

This procedure ensures that instruments and systems are installed and functioning as designed. Correct installation is the first step in ensuring that instruments and systems operate reliably over their lifetimes.

Customer responsibilities

- 1 Make sure your site meets the basic requirements, including the necessary space, electrical outlets, gases, tubing, operating supplies, consumables and other usage-dependent items, required for a successful installation. Refer to the *Agilent 8890 Gas Chromatograph GC, GC/MS, and ALS Site Preparation Guide*.
- 2 If Agilent is delivering installation and familiarization services, users of the instrument should be present throughout these services; otherwise, these users will miss important operational, maintenance, and safety information.

Additional information is available via the GC Touchscreen, Browser Interface help & information suite, and the Agilent *GC and GC/MS User Manuals & Tools DVD*.

About Agilent's installation service

The installation service does not include:

- Network setup with other computers, or to the site or building LAN.
- Customization of the system.
- Method development and testing.
- Analysis of customer standards or samples.
- Testing against the instrument performance specification.

If you need assistance beyond this installation service, please contact your local Agilent office. Assistance with installation and with user-specific services and applications is available and will be contracted separately.

Tools and additional parts required

Installation requires the following tools, fittings, and hardware. **These items are not included with the instrument.**

- Precleaned copper tubing, 1/8-inch or 1/4-inch od.
- Fittings.
- Tubing cutter.
- Filters for gas supplies.
- 7/16-inch and 9/16-inch wrenches for assembling Swagelok fittings.
- Carrier and other gas supplies.

- Pressure regulator for each gas supply.
- A computer, tablet, or other LAN capable device (for accessing GC user information and for updating GC firmware when needed).
- Any additional LAN components, such as cables and a switch or hub, for connection to the site LAN (not included in Agilent installation services).

The Agilent 8890 Gas Chromatograph GC, GC/MS, and ALS Site Preparation Guide contains a listing of Agilent installation kits and a description of parts included with each kit. These kits contain filters, fittings, tubing, tools (wrenches, tubing cutter, drivers, and so on), and other required parts for installing a GC.

Performing checkout

Checkout requires a system that can produce a chromatogram.

- If using an Agilent data system, you can perform the checkout procedure. Read these GC installation instructions and the instructions for installing the data system.
- If connected only to an integrator or site system (for example, a LIMS system) that captures the GC output signal, you must connect to that system to obtain the chromatogram.

System installation

If installing an ALS, the ALS can be used for checkout. Refer to the ALS installation documentation for details.

When installed as part of a complete system including an Agilent data system (for example, Agilent OpenLAB CDS), first install the GC up to the checkout column bakeout step. Once the bakeout ends, configure the new GC in the data system and open the online instrument session. Use the data system to perform the checkout test.

When installed as part of other complete systems, for example in an Agilent GC/MSD or GC/MS system, refer to the installation instructions for that system.

Configuring the GC

To configure the various components of your GC, you must use either the Touchscreen or access the Browser Interface from a computer on the same network as your GC. For more information about connecting to the Browser Interface, see [“Connecting to the Browser Interface”](#).

To access the copy of this manual stored on your GC, enter **http://<your GC's IP address>/install** into the web browser of your choice.

Connecting to the Browser Interface

To connect to the GC using a browser:

- 1 If you do not know the GC's IP address or host name, use the touchscreen to find it.
- 2 Open a web browser. Supported browsers include Chrome, Safari (on a tablet), Internet Explorer 11, and Edge. Make sure the browser version is up to date.
- 3 Enter `http://xxx.xx.xx.xxx`, where `xxx.xx.xx.xxx` is the GC's IP address. (If using a host name, enter it instead.) In this example, the GC IP address is 10.1.1.101. Accessing the Browser Interface only requires that the tablet or computer be connected to the same gateway as the GC; no internet connection is required.

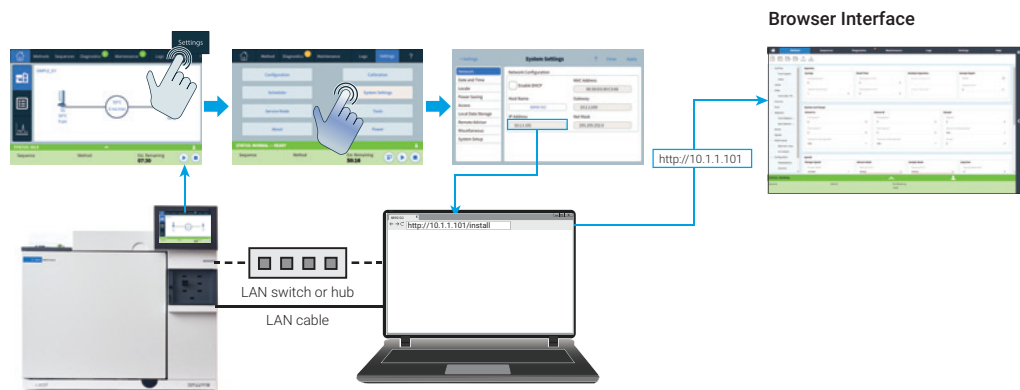

The 8890 GC

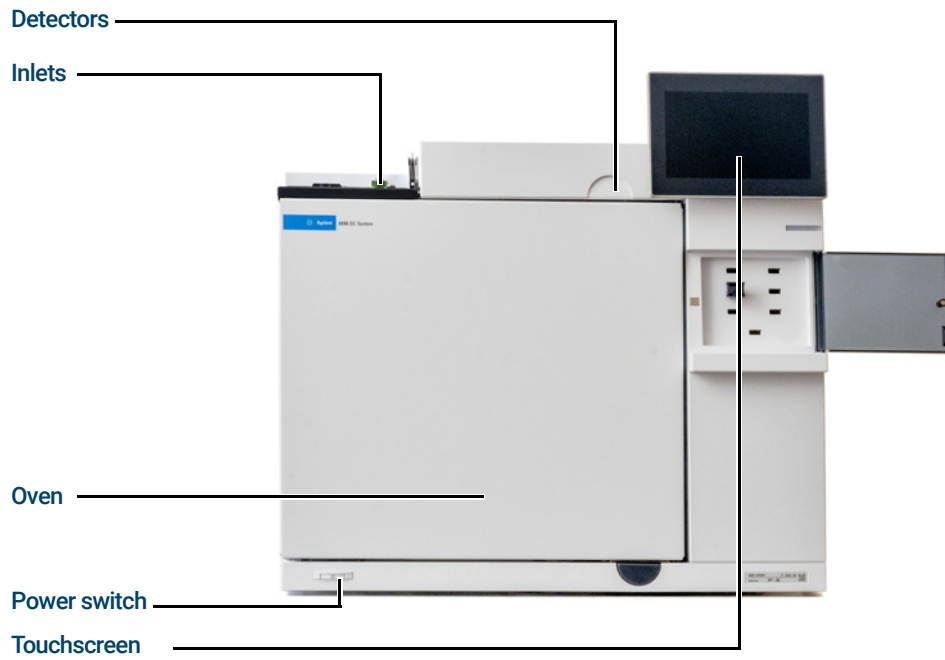

Figure 1. Front of the 8890 GC

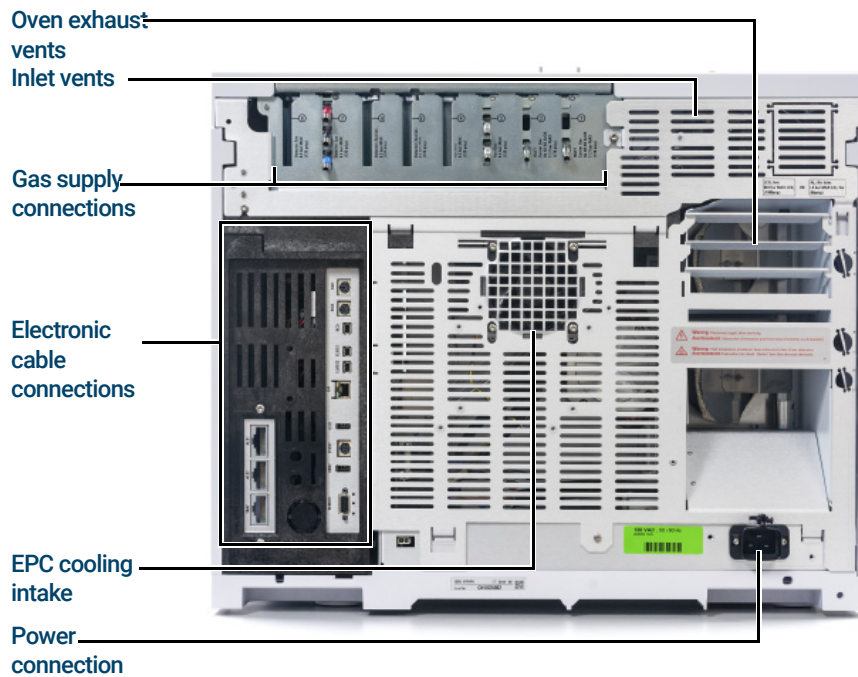
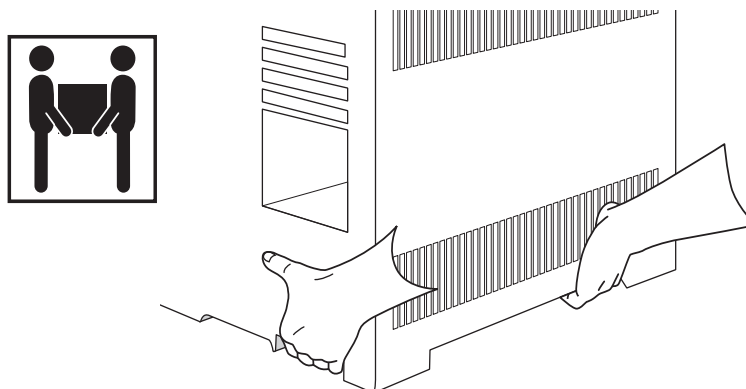

Figure 2. Back of the 8890 GC

Unpacking

WARNING

Be careful when lifting the GC. Because it is heavy, two people should lift it. When moving the GC, be aware that the back is heavier than the front.



- 1 Inspect the shipping containers for damage.
- 2 If a container is damaged or shows signs of stress, do the following:
 - a Notify both the carrier and your local Agilent sales office.
 - b Keep all shipping materials for inspection by the carrier.
- 3 Check the items received against the packing lists.
- 4 If there are discrepancies, notify your local Agilent sales office immediately.
- 5 Retain the shipping containers until you check their contents for completeness and verified instrument performance.

Step 1 Place the GC on the bench

The GC requires a bench that can support its weight plus that of other equipment you will use with it. The area must be free of overhanging obstructions that might interfere with autosamplers, or that limit access to the top of the instrument. The area must include sufficient space behind the GC to allow for cooling.

- 1 Remove the GC from its shipping box.

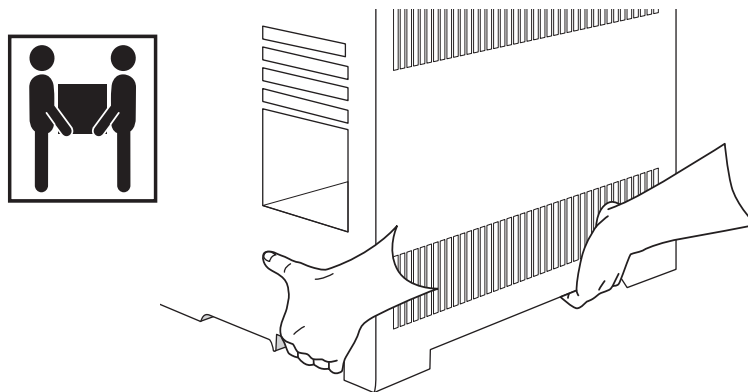

- 2 Place the GC on the bench top. Make sure gas and power supplies are accessible. Place related equipment near the GC.

WARNING

The power cord is the power disconnect device. Do not position the instrument such that access to the coupler or plug is impaired.

CAUTION

Make sure your GC has adequate distance from the wall and other instruments.

- 3 If space is limited behind the GC, attach the optional oven exhaust deflector to the back of the GC as shown below. (Order Option 306 or part number G3450-81650.) The deflector hangs from the exhaust vents on four hooks.

1 Installing the GC

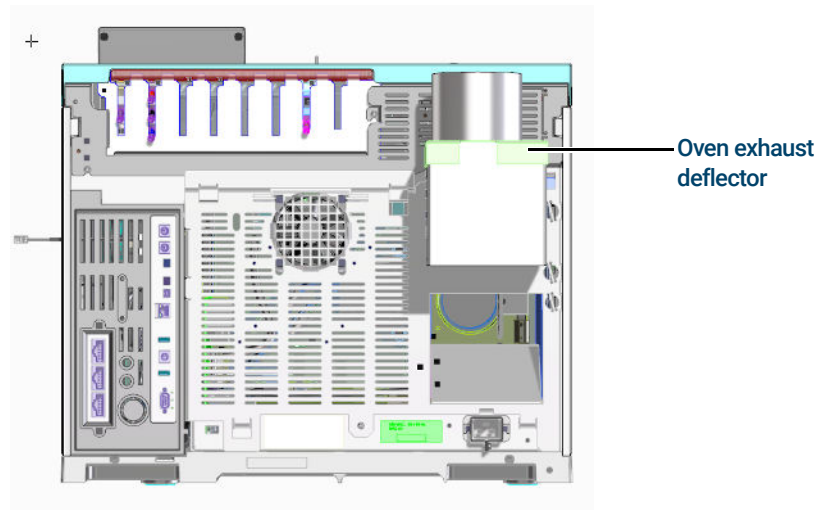

Figure 3. Correct position of the oven exhaust deflector

The oven exhaust deflector accepts a 10-cm (4 in.) diameter exhaust duct, and adds about 13 cm to the depth of the GC, but this additional depth does not increase the depth required for proper ventilation.

Step 2 Verify line voltage, voltage settings, and power cord

- 1 Locate the power label near the power cord connector on the back of the GC. Compare the instrument power settings with the laboratory line voltage. See **“Power consumption”** on page 16.
- 2 Verify that the power cord is correct for the voltage and location. **“Power cords available”** on page 17.

WARNING

Electrical shock hazard. To avoid injury, only a qualified person should measure line voltage.

- 3 Have a qualified person measure the actual power outlet voltage and verify that it meets the tolerance requirements listed in **Table 1** on page 16. See **“Grounding”** on page 21” and **“Line voltage”** on page 15.

The following sections detail the power specifications and requirements for reference.

Line voltage

Typical GC System - 8890 GC with computer and printer.

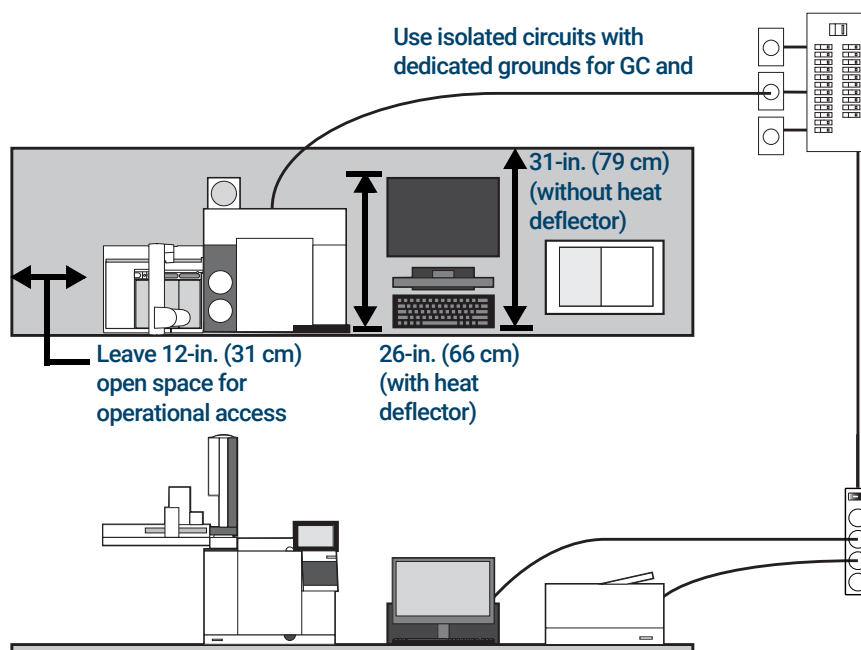

WARNING

To protect users, the metal instrument panels and cabinet are grounded through the three-conductor power line cord in accordance with International Electrotechnical Commission (IEC) requirements.

A proper earth ground is required for GC operations. Any interruption of the grounding conductor or disconnection of the power cord could cause a shock that could result in personal injury.

Be sure to verify proper receptacle grounding.

WARNING

Do not use extension cords with Agilent instruments. Extension cords normally are not rated to carry enough power and can be a safety hazard.

- 1 Make sure that each instrument in your GC system can be connected to a dedicated circuit with an isolated ground. (Note that ALS instruments receive their power from the GC.)
- 2 Power requirements are printed near the power cord attachment on the rear panel of each instrument. Although your GC should arrive ready for operation in your country, compare its voltage requirements with those listed in **Table 1** on page 16. If the voltage option you ordered is not suitable for your installation, contact Agilent.

Power consumption

The number and type of electrical outlets required for installation depends on the size and complexity of your system. A GC system with a computer, monitor, printer, and hub requires 5 outlets. **The outlet for the GC must be a dedicated circuit.**

Each GC has a label next to the power cord connector that lists its line voltage requirements. See the examples below.



The GC power consumption and requirements depend on the type of oven that you ordered and the country the unit shipped to. Fast oven options 002 and 003 require more power than the standard oven.

See your *Site Preparation Guide* for a list of the power cords available for the GC. If your power cord is incorrect, order the cord appropriate for the country.

Table 1 GC power requirements

Oven	Line voltage	Frequency	Current	Power	Power outlet current rating
Standard	Americas: 120 V AC (1) single phase, +10 to -10%	48-63 Hz	18.8 amps	2250 VA	20 A
Standard	220/230/240 V single/split phase, +10 to -10%	48-63 Hz	10.2 / 9.8 / 9.4 amps	2250 VA	10 A

1 Installing the GC

Table 1 GC power requirements (continued)

Oven	Line voltage	Frequency	Current	Power	Power outlet current rating
Fast	Japan: 200 V split phase, +10 to -10%	48-63 Hz	14.8 amps	2950 VA	15 A
Fast	220/230/240 V (2)(3) single/split phase, +10 to -10%	48-63 Hz	13.4 / 12.8 / 12.3 amps	2950 VA	15 A



Notes

- 1 Some US labs have 3 phase service resulting in 208 V at the wall receptacle. It is important for a qualified person to measure the line voltage at the receptacle for the GC. Option 003, 208 V fast oven, uses a 220 V unit with operating range of 193 to 231 V.
- 2 Power line conditioners should not be used with the GC.

Power cords available

Table 2 lists the power cords available for the GC. If your power cord is incorrect, order the cord appropriate for the country.

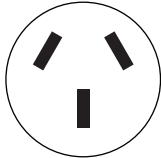
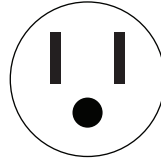
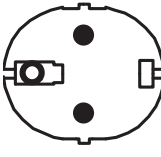
Table 2 Power cords by country

Part number	Country	Description	Wall termination	Plug termination
8120-1369	Australia, New Zealand	Power Cord, Australia/NZ, C13, 10 amp	AS 3112	
8120-1378	Americas	Cable Assembly-Power Cord 18AWG 2.3m-LG	NEMA 5-15	
8120-1689	Europe	Cable Assembly-Power Cord 17AWG 2m-LG PV	CEE/7/V11	
8120-2104	Switzerland	Cable-Assembly-Power cord 250VAC 10A 3-C	Swiss/Denmark 1302	

1 Installing the GC

Table 2 Power cords by country (continued)

Part number	Country	Description	Wall termination	Plug termination
8120-3997	Denmark, Greenland	Power Cord, DK/Greenland, C13, 10 amp	AFSNIT 107-2-01	
8120-4211	India, South Africa	Power Cord, India/S Africa, C13, 10 amp	AS 3112	
8120-4753	Japan	Power Cord, Japan, C13, 125V	NEMA L6-20P	
8120-5182	Israel	Power Cord, Israel, C13, 10 amp	Israeli SI32	
8120-6360	Taiwan, South America	Power Cord, Taiwan/S America, C19, 20A	NEMA 5-20P	
8120-6869	Argentina	Power Cord, Argentina, C13 250V 10A RA/3	AS 3112	
8120-6894	US	Power Cord, US 120V, C19, 20 amp	NEMA 5-20P	

1 Installing the GC

Table 2 Power cords by country (continued)

Part number	Country	Description	Wall termination	Plug termination
8120-6903	Japan	Power Cord, Japan, C19, 20 amp	NEMA L6-20P	
8120-6978	Chile	Power Cord, Chile, C13, 10 amp	CEI 23-16	
8120-8619	Australia	Power Cord, Australia, 16 amp	AS 3112	
8120-8620	Great Britain, Hong Kong, Singapore, Malaysia	Power Cord, GB/HK/SG/MY, C19, 13 amp	BS1363	
8120-8621	Europe	Power Cord, Europe, 16 amp	CEE7/V11	
8120-8622	Switzerland, Denmark	Power Cord, Swiss/DK, C19, 16 amp	Swiss/Denmark 1302	
8120-8705	Great Britain, Hong Kong, Singapore, Malaysia	Power Cord, GB/HK/SG/MY, C13, 10 amp	BS89/13	
8121-0070	China	Power Cord PRC Fast	GB 1002	

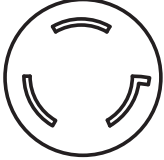
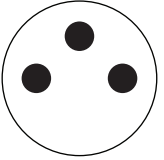
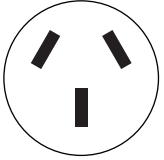
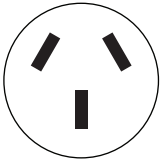
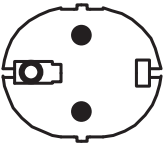
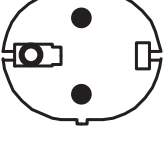

1 Installing the GC

Table 2 Power cords by country (continued)

Part number	Country	Description	Wall termination	Plug termination
8121-0075	US	Power Cord, US 240V, C19, 15 amp	NEMA L6-15P	
8121-0161	Israel	Power Cord, Israel, C19, 16 amp	Israeli SI32	
8121-0675	Argentina	Power Cord, Argentina, C19, 20 amp	AS 3112	
8121-0710	India, South Africa	Power Cord, India/S.Africa, C19, 15 Amp	AS 3112	
8121-0723	China	Power Cord, China, C13, 10 amp	GB 1002	
8121-1222	Korea	Power Cord, Korea, C19, 16 amp	CEE7/V11	
8121-1226	Korea	Power Cord, Korea C13, 10 amp	CEE7/V11	
8121-1301	Thailand	Power Cord, Thai 220V, 15 A, 1.8M, C19		

1 Installing the GC

Table 2 Power cords by country (continued)

Part number	Country	Description	Wall termination	Plug termination
8121-1787	Brazil	Power Cord, Brazil, C19, 16 A, 250V Max	IEC 60906-1	
8121-1809	Brazil	Power Cord, Brazil, C13, 10 A, 250V Max	IEC 60906-1	

Grounding

To protect users, the metal instrument panels and cabinet are grounded through the three-conductor power line cord in accordance with International Electrotechnical Commission (IEC) requirements.

When plugged into a properly grounded receptacle, the three-conductor power line cord grounds the instrument and minimizes shock hazard. A properly grounded receptacle is one that is connected to a suitable earth ground. Proper receptacle grounding should be verified.

Make sure the GC is connected to a dedicated circuit.

Step 3 Connect GC to LAN, Local Computer, or Tablet

If you intend to connect your system to your site's LAN network, you must have an additional shielded twisted pair network cable (8121-0940).

Use a network cable to connect the GC LAN port to your site LAN or directly to a local computer.

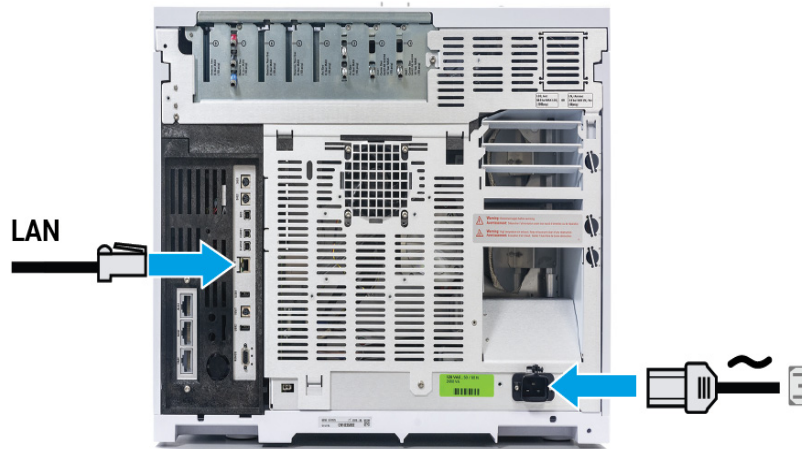

Figure 4. LAN connection

A single LAN communications cable is supplied with the GC. The switch (or hub) and other cables must be ordered separately, if needed.

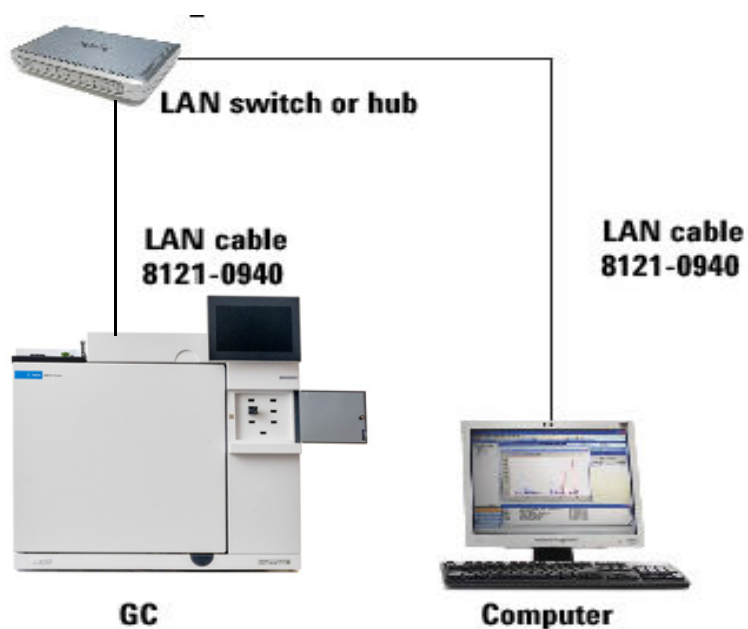

Figure 5. Simple supported LAN configuration: LAN Switch or hub

NOTE

Agilent is not responsible for connecting to or establishing communication with your site LAN network. The Agilent representative will test the system's ability to communicate on a mini-hub or LAN switch only.

Step 4 Connect the power cord and turn on the GC

- 1 Verify that the power switch is in the Off position.



Figure 6. Power switch location

- 2 Plug the power cord into the back of the GC and the power outlet.

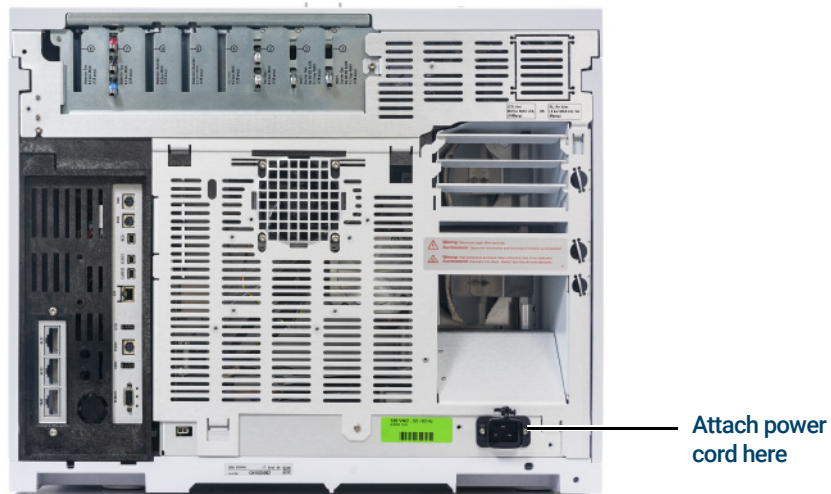
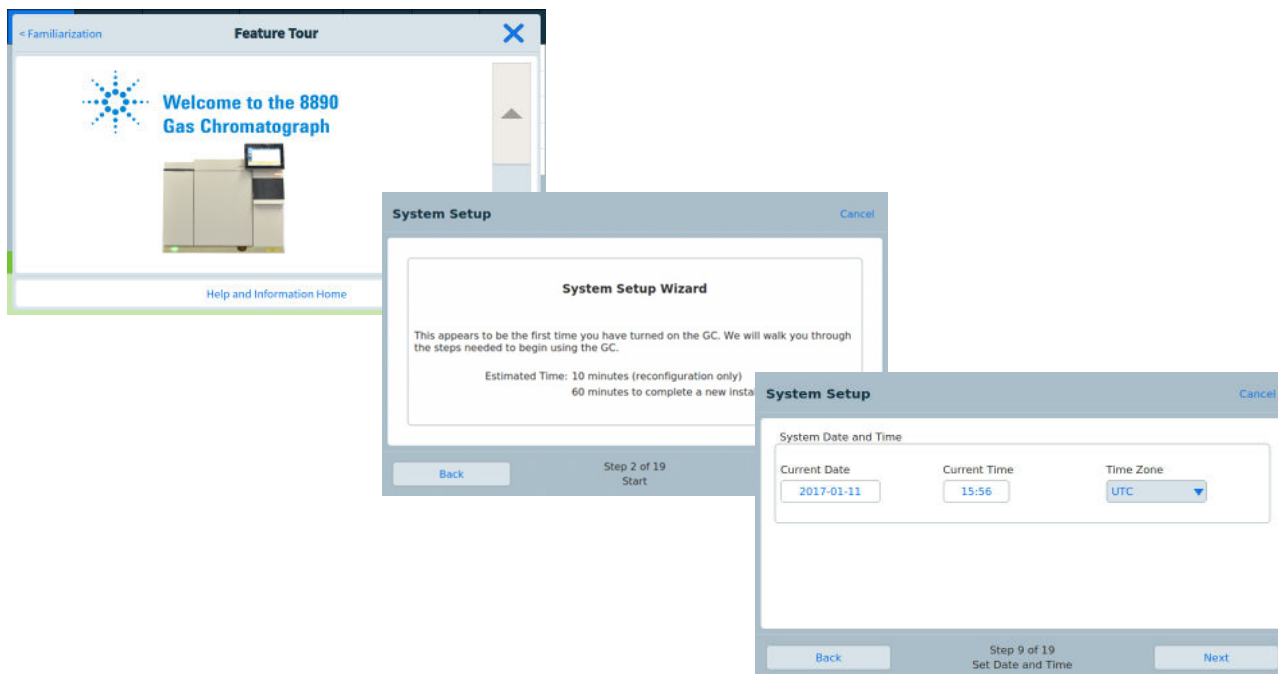

Figure 7. Power cord location

Step 5 View the System Setup Wizard

The system setup wizard walks through the most important steps needed to install and configure the GC. It provides a way to enter only the critical settings needed to get started quickly, leaving all other configuration settings at their default values. These steps include:

- Unpacking
- Setting the system date, time, and IP address
- Setting the gas units, gas types, and similar choices
- Connecting gases and checking for leaks
- Installing a sampler, if available
- Running a checkout sample



You can follow the system setup wizard, or cancel it and follow the procedures here instead. Whether using the wizard or not, this guide provides all of the supporting information needed for installation.

After exiting the system setup wizard, you can re-launch it at any time. On the GC touchscreen, navigate to **Settings > System Setup** and touch **Run System Setup**.

Step 6 Configure the GC IP address

If you intend to connect your system to your site’s network, each piece of equipment must have a unique IP address assigned to it. For an isolated LAN installation, see **Table 3** for typical IP addresses.

Table 3 Typical IP addresses for an isolated LAN

	GC	Computer
IP address	10.1.1.101	10.1.1.100
Subnet mask	255.255.255.0	255.255.255.0

- 1 Select **Settings > System Settings > Network**.

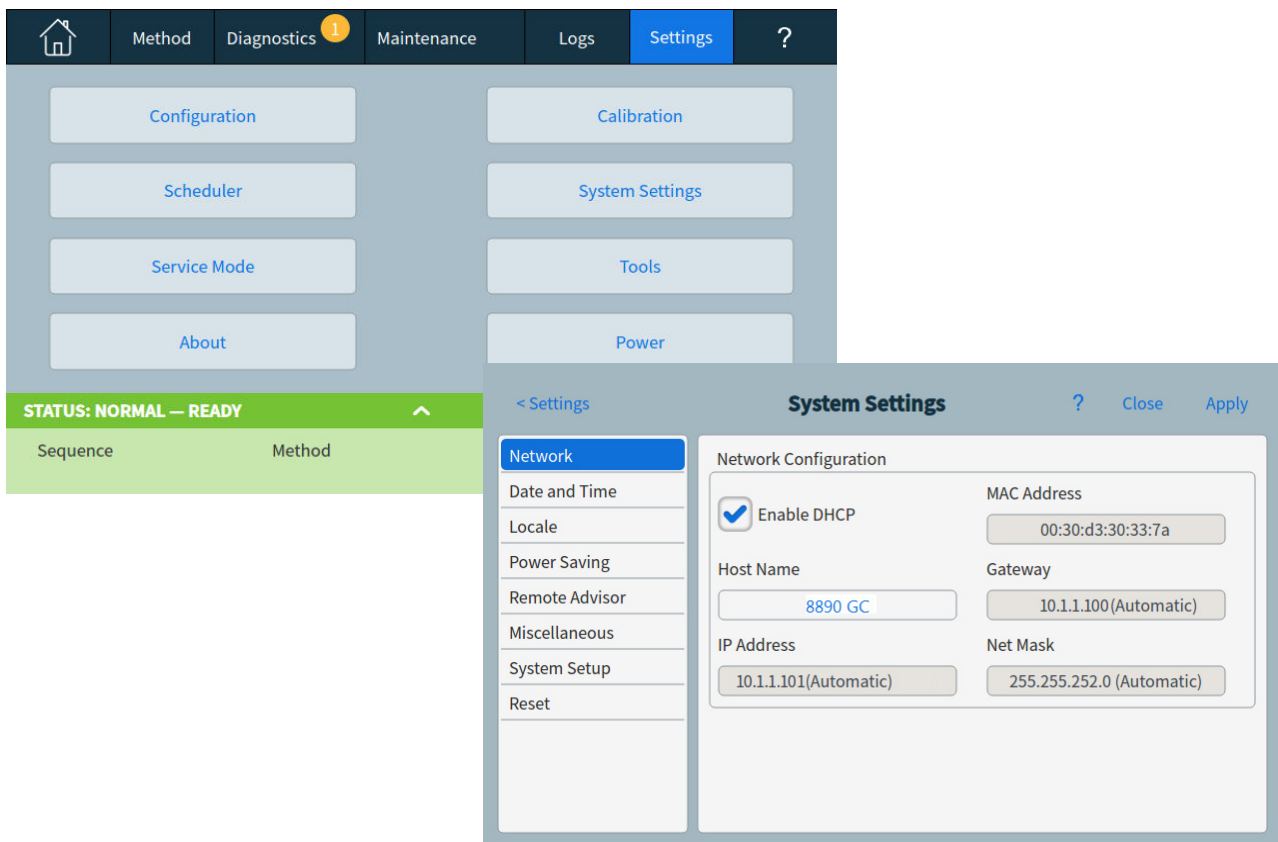

- 2 Manually enter the GC **Host Name**, **IP address**, **Gateway**, and **Net Mask** (subnet mask), or enable DHCP to propagate these fields.

Step 7 Set the Date/Time

Select **Settings > System Settings > Date and Time** and set the GC clock.

- The **Current Time** is based on a 24 hour clock.
- The time set here is important for the time and date stamps used when collecting data and recording log entries (such as maintenance tasks and errors). The GC time also controls resource conservation for connected samplers.

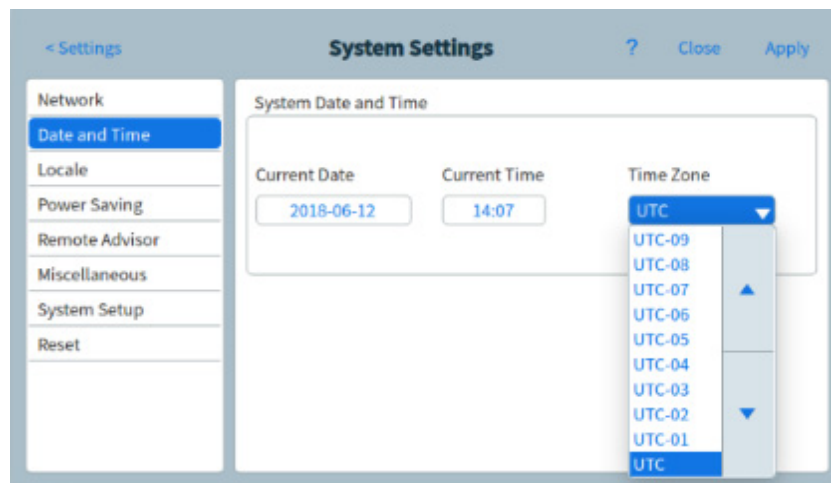

Step 8 Set the Pressure Units

To set the pressure units, select **Settings > Configuration > Misc**, and select the desired pressure units to use in methods.

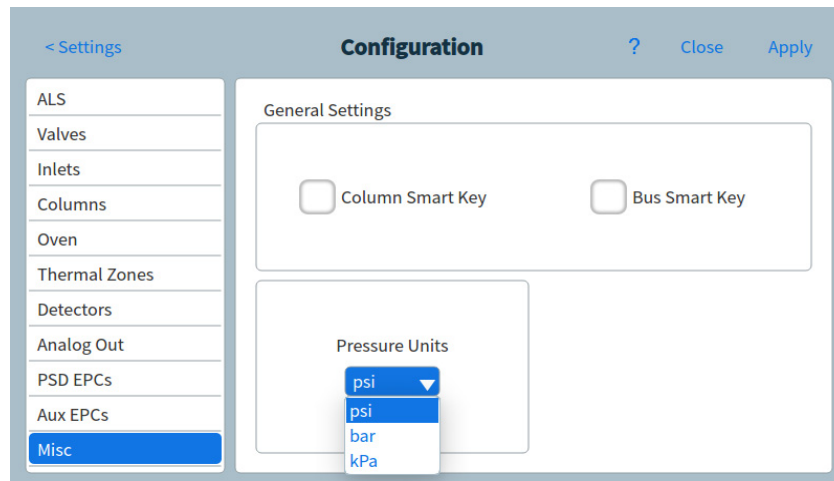

Step 9 Configure Carrier Gas Types

Select **Settings** > **Configuration** > **Inlets** and use the dropdown menu to select the Carrier Gas Type connected to the selected inlet. Repeat for any additional inlets installed in your GC.

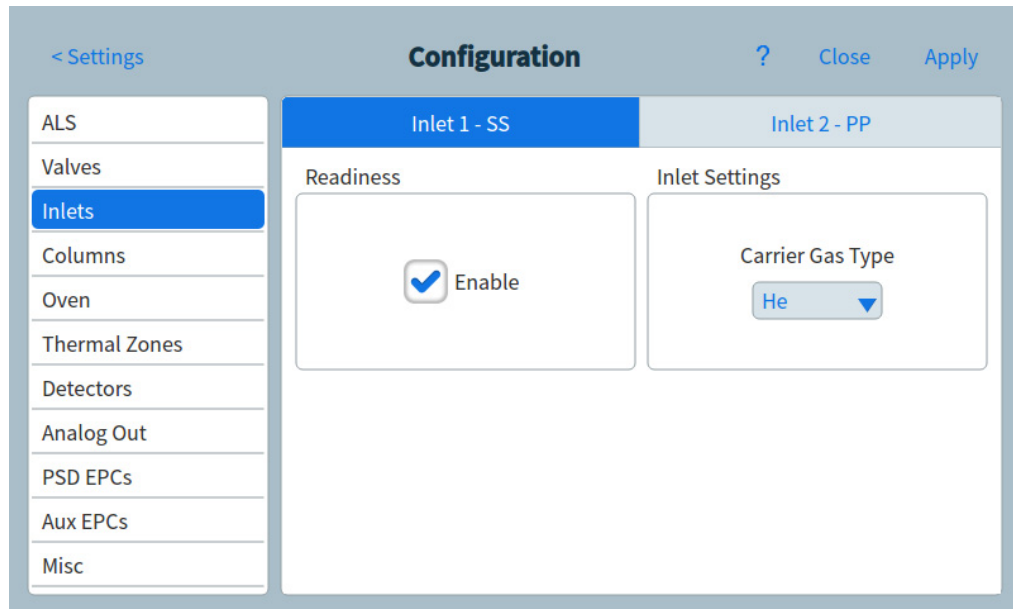

Step 10 Connect Gases and Traps

Most of installation involves plumbing gas to tanks, filters, and flow modules. Swagelok fittings are used to make leak-tight connections. If you are not sure how to make a Swagelok connection, see **Appendix A**, "Making Swagelok Connections" for instructions.

WARNING

Hydrogen is a flammable gas. If hydrogen or any other flammable gas is used, periodic leak tests should be performed. Be sure that the hydrogen supply is off until all connections are made, and insure that the inlet fittings are either connected to a column or capped at all times when hydrogen gas is present in the instrument.

Substituting parts or performing any unauthorized modification to the instrument may result in a safety hazard.

The insulation around the inlets, detectors, valve box, and the insulation cups is made of refractory ceramic fibers (RCF). To avoid inhaling RCF particles, we recommend these safety procedures: ventilate your work area; wear long sleeves, gloves, safety glasses, and a disposable dust/mist respirator; dispose of insulation in a sealed plastic bag; wash your hands with mild soap and cold water after handling RCFs.

Install the gas regulators

- 1 Select the appropriate CGA regulator for each gas type. (In other countries, refer to local standards. See the *Agilent GC, GC/MS, and ALS Site Preparation Guide* for requirements.)

Table 4 Gas regulators, 1/8-inch, U.S. only *

Description	Part number
CGA 346, 125 psig max (8.6 bar), Air	5183-4641
CGA 350, 125 psig max (8.6 bar), H ₂ , Ar/Me	5183-4642
CGA 540, 125 psig max (8.6 bar), O ₂	5183-4643
CGA 580, 125 psig max (8.6 bar), He, Ar, N ₂	5183-4644
CGA 590, 125 psig max (8.6 bar), Air	5183-4645

* For 1/4-inch tubing, purchase a 1/4-inch to 1/8-inch adapter, U.S. only.

CAUTION

Never use a liquid thread sealant on gas fittings. Liquid thread sealants introduce contamination into the GC plumbing.

- 2 Confirm that the outlet fitting of the regulator is 1/8-inch Swagelok. If not, install the appropriate adapter fitting. Wrap the fitting threads using PTFE tape. Wrap the tape in a clockwise direction so that the adapter threads do not unwrap the tape. Be careful to keep the tape away from the end of the fitting. Two to three tightly wound wraps are sufficient. Tighten the Swagelok adapter fitting securely to the NPT pipe thread fitting.

1 Installing the GC



- 3 Install the regulator onto the compressed gas cylinder main fitting.
 - Check the thread type. Some regulators use left-hand thread fittings. For left-handed threads, the nut will have a groove in it.



- 4 Purge the air from the regulator by repeating the following procedure 5 times:
 - a Fully close the regulator knob, then open the main tank valve.
 - b Turn the regulator knob fully counter-clockwise to open the tank main valve, pressurizing the primary side of the regulator.
 - c Turn OFF the tank main valve.
 - d Slowly turn the regulator knob clockwise to release ("bleed off") the gas pressure.
 - e Close the regulator knob.

The image below illustrates a typical pressure regulator installation. In the example shown below, which uses an optional shutoff valve, open the shutoff valve and leave open during purging.

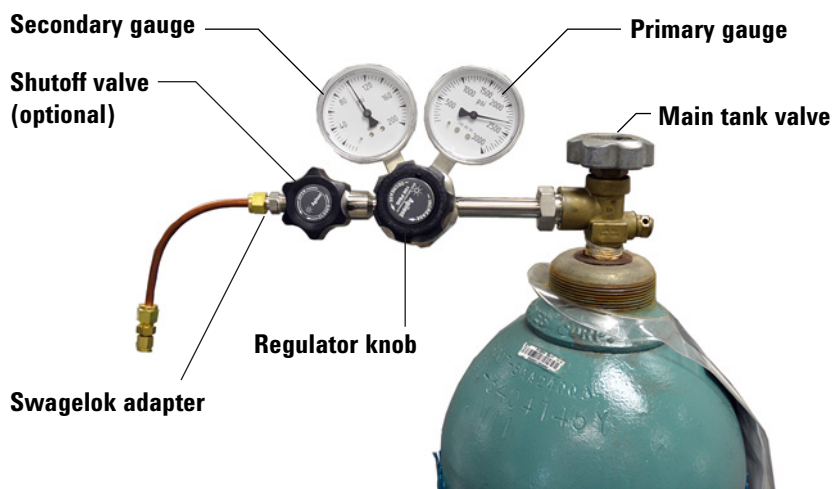

Connect the tubing to the gas source

NOTE

If you need more than 4.5 m (15 feet) of supply tubing to connect to a gas source, use 1/4-inch tubing with appropriate hardware. See the *Agilent GC, GC/MS, and ALS Site Preparation Guide* for part numbers.

- 1 Turn off all gases at their sources. Measure the length of tubing needed to connect the gas supply outlet to the inlet fitting on the GC. Take into account any traps or tees you will need.
- 2 Cut the tubing to length with a tubing cutter. See [Figure 8](#).

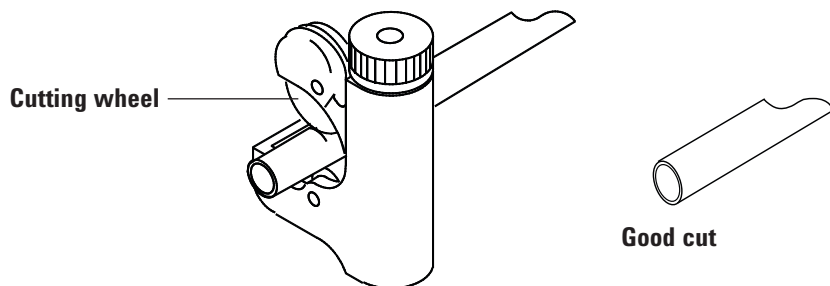

Figure 8. Typical tubing cutter

- 3 Connect the tubing to the gas source with a Swagelok fitting. See [Appendix A](#), "Making Swagelok Connections".

Install traps

- 1 Determine where you will install the traps in your supply tubing line. **Figure 9** shows the recommended trap order for the carrier gas and the recommended locations for On/Off valves. Also see the *Site Preparation Guide*.

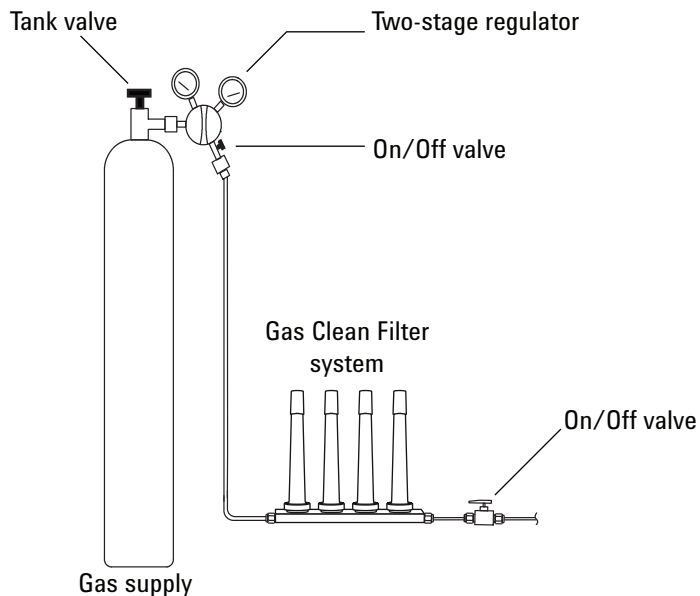

Figure 9. Plumb the gas supplies

- 2 Cut the tubing to length with a tubing cutter.
- 3 Connect the traps and tubing. On/Off valves are not essential, but are very useful when a tank or trap must be changed. (If purchasing Agilent compliance services, install an on/off valve for each inlet gas supply.)

Plumb to EPC flow modules

Inlet and detector EPC flow modules are mounted very close together across the back of the GC. See **Figure 10**.

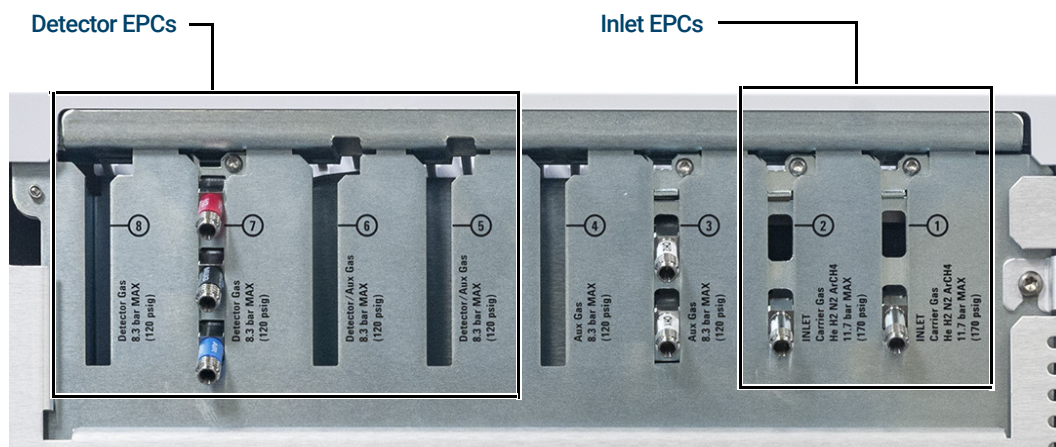

Figure 10. Plumb flow modules

Purge the supply lines for a few minutes before connecting them to the GC flow modules.

WARNING

Be sure to vent uncombusted hydrogen to a fume hood or other safe location.

When two inlets use the same carrier gas, we recommend using a Tee fitting that includes shutoff valves for performing leak tests.

When two detectors use the same gases, we recommend using a Tee fitting. Shutoff valves are not required.

TCD connections The carrier gas and reference gas must come from the same source. Because of the close spacing of the EPC modules, the simplest way to do this is to attach lengths of tubing to each input to bring the ends outside the back panel, then join them with a Tee.

Side mounted detector connections If the GC is equipped with a side-mounted TCD or ECD, attach the carrier gas to the single gas connection at the back of the side mount enclosure. (For TCD, an internal Tee feeds the reference gas and input.)

Install Aux EPC module frits for your application

Skip this section if an Aux EPC module is not installed.

The AUX EPC module ships with brown (FID air) restrictors in all channels. For certain applications, you will have to replace this restrictor (frit) so the EPC module can provide flows in the correct ranges. See **Table 5**. Also refer to the other instrument's or application's documentation.

Table 5 G3470-60502 Aux EPC restrictor kit

Kit contains	Part number	Marking	Flow	Resistance	Often used with
O-rings, 6/pk	5181-3344				
None	G3430-80061	1 ring Brown	400 ± 30 SCCM air @ 40 psig	Low	FID air, purged splitters, Deans switch
3	G3430-80062	2 rings Red	30 ± 1.5 SCCM H2 @ 15 psig	Medium	FID hydrogen
3	G3430-80063	3 rings Blue	3.33 ± 0.3 SCCM H2 @ 15 psig	High	NPD hydrogen
3	G3430-20011	None		Zero (none)	Purged splitter, Deans switch when using backflush

Notes for this table

- Frit G3430-80061 ships in each AUX channel.
- Restrictor kit G3470-60502 is included in the AUX module ship kit.
- Always use new O-rings (part number 5181-3344, O-rings, 6/pk).
- Install tubing and connectors as needed for each additional gas supply required.

1 Installing the GC

- Do **not** install an external flow restrictor.

Install hydrogen sensor calibration gas

If available, install the hydrogen sensor calibration gas. The hydrogen sensor ship kit includes a pressure regulator that installs directly onto the calibration gas cylinder. Agilent also provides sufficient copper tubing and hardware to connect the pressure regulator to the hydrogen sensor assembly calibration gas input fitting.

- 1 Set the gas cylinder stand upright on the lab bench near the GC.

WARNING

The gas cylinder is pressurized. Do not place the cylinder on its side or behind the oven exhaust vent!

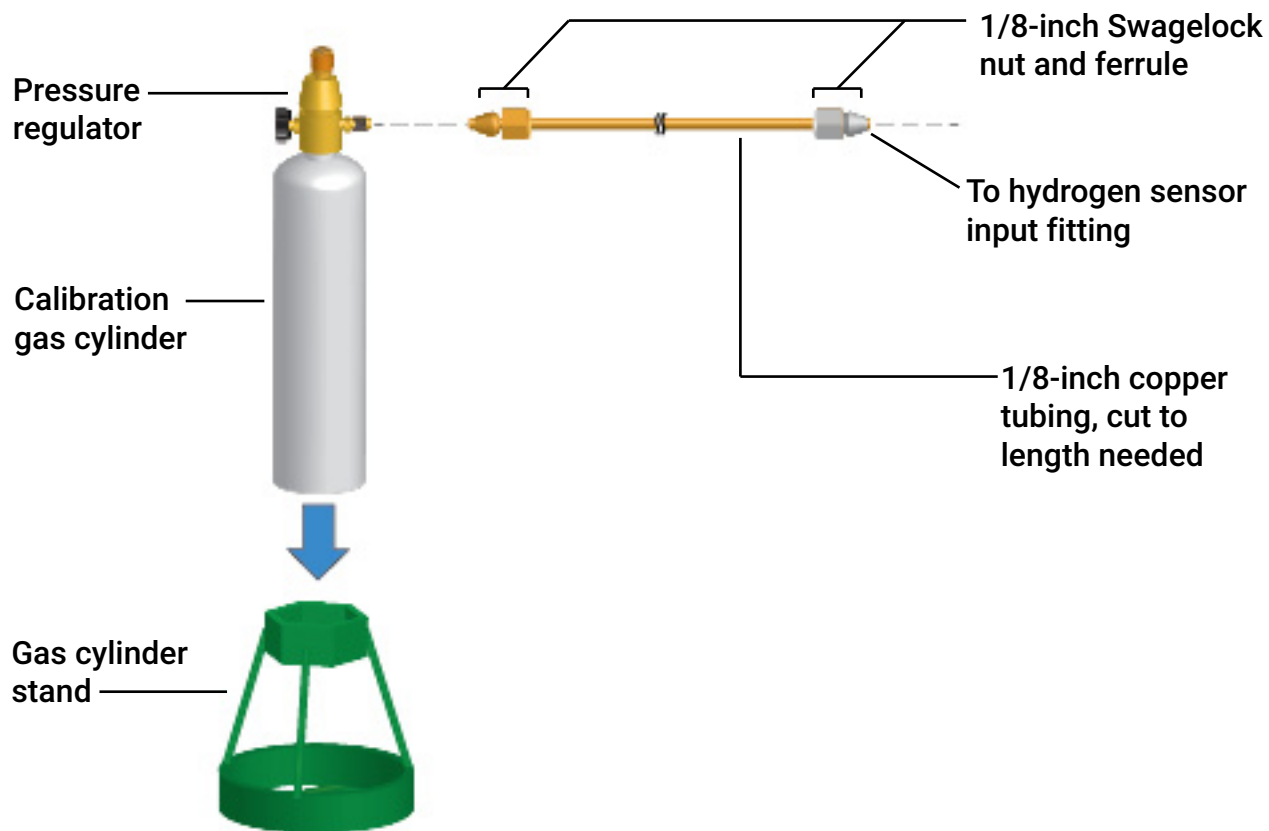

- 2 Turn the pressure regulator completely off and set the output pressure as low as possible (full CCW).

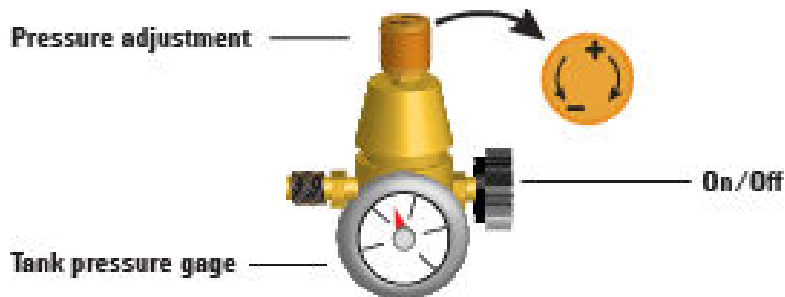

- 3 Install the pressure regulator onto the calibration gas cylinder (it screws on).

1 Installing the GC

- 4 Connect the calibration gas cylinder output tubing to the hydrogen sensor module.
 - Use the tubing, nuts, and ferrules provided in the hydrogen sensor kit.
 - See the figure under **step 1**.
- 5 Install the calibration gas cylinder into the stand and secure using the screw.
- 6 Turn on the supply pressure at the pressure regulator. (You will adjust it later.)
- 7 Check for leaks in the fittings using a leak detection fluid. Correct any leaks.

Step 11 Leak test all connections and set source pressures

Liquid leak detectors, such as soapy water, are not recommended, especially in areas where cleanliness is very important. If there is a leak, these liquids can contaminate the plumbing and affect your analyses. If you do use leak detection fluid, immediately rinse the fitting to remove the soapy film.

When checking for leaks of hydrogen or helium, Agilent recommends the G3388B leak detector, or similar.

WARNING

To avoid a potential shock hazard when using liquid detection fluid, turn the GC off and disconnect the main power cord. Be careful not to spill leak solution on electrical leads.

Perform a pressure drop test.

- 1 Turn off the GC.
- 2 Set the regulator pressure to 415 kPa (60 psi).
- 3 Fully turn the regulator pressure adjustment knob counterclockwise to shut the valve.
- 4 Wait 10 min. If there is a pressure loss greater than 7 kPa (1 psi), there is a leak in the external connections. Use the leak detector to check each fitting for leaks. See **Figure 11**.

1 Installing the GC

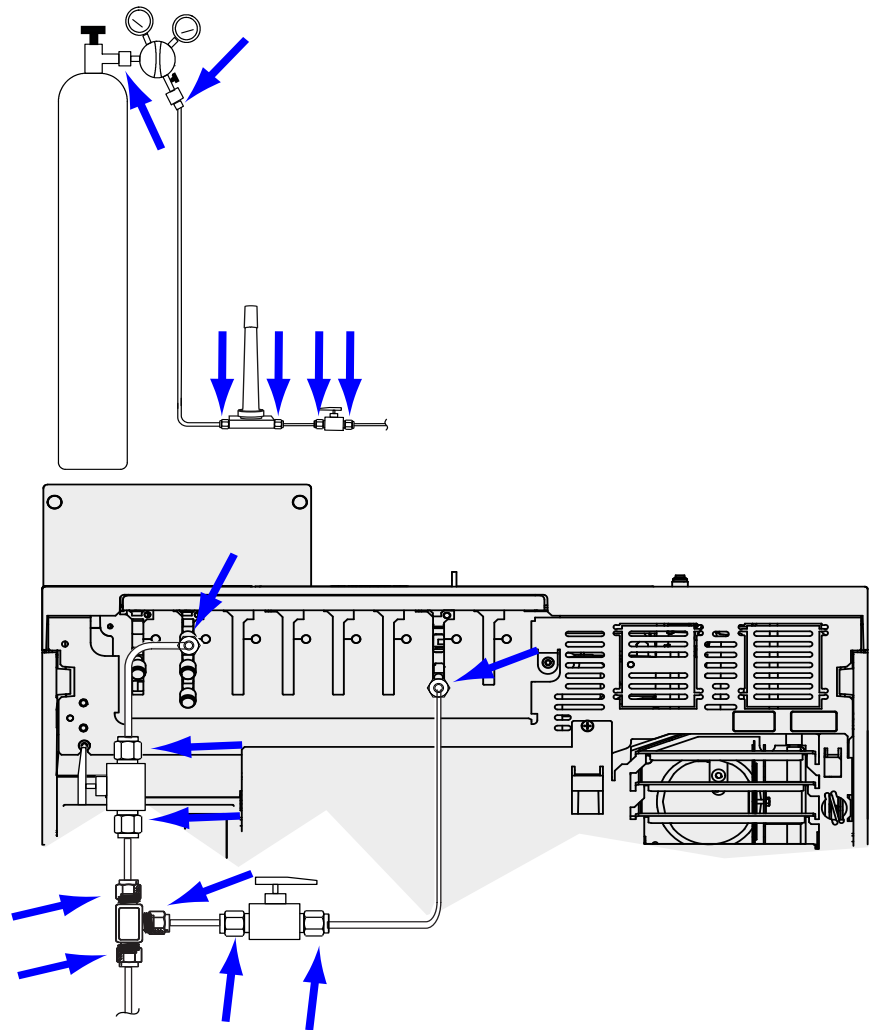

Figure 11. Locations to check for leaks

- 5 Correct leaks by tightening the connections and then retest the connections. Continue tightening until all connections are leak-free.

Set source gas pressures

The pressure set at a tank regulator depends on these factors:

- The inlet pressure needed to achieve the highest column flow rate required by your method.

The pressure/flow relationship depends on the column or device involved. The best way to address this is to begin at a moderate pressure level and adjust upward as needed.

- A pressure difference of about 170 kPa (25 psi) across flow controlling devices enables them to work properly.
- The pressure limit of the weakest part of the supply system.

Swagelok fittings and copper tubing are more than adequate for the highest pressures used in gas chromatography.

We recommend a maximum continuous operating pressure of 1170 kPa (170 psi) to avoid excessive wear and leaks.

Traps are often the weakest part of the system. They should be labeled, either on the trap itself or in accompanying literature, with a maximum operating pressure. Source pressure must not exceed the lowest maximum operating pressure in the supply system.

Table 6 suggests starting values of source pressure.

Table 6 Suggested starting pressures

Gas	Use	Source pressure
Carrier	Packed column	410 kPa (60 psi)
	Capillary columns	550 kPa (80 psi)
Air for FID, FPD	Detectors	550 kPa (80 psi)
Hydrogen	Detectors	410 kPa (60 psi)
Makeup gas	Detectors	410 kPa (60 psi)
TCD Reference	TCD	410 kPa (60 psi)
Air for valve actuators	Valves	345 kPa (50 psi)

Step 12 Install inlet checkout parts

If using a split/splitless or multimode inlet, install the liner and O-ring needed for checkout. See the Operation manual, and the procedures listed in *Maintaining Your GC*.

If installing a GC/MS system, refer to the GC/MS installation manuals for the correct inlet hardware to install, as needed.

Step 13 Install ALS, if ordered

If installing an ALS, install it now. Refer to its instructions.

Prepare the sampler for checkout. See the checkout procedures and information in the Operation Manual.

- 1 Prepare a 2-mL screw-top sample vial with checkout sample.
- 2 Prepare 4-mL waste vials and place them into the turret.
- 3 Prepare fresh solvent solutions as needed for the checkout sample for your detector type. Place the solvent vials into the injector turret. For details on the solvent needed, see the *Operation Manual*.

Step 14 Configuring GC-MSD communications

If connected to an MSD such as 5977A or 7000C/D, use the GC touchscreen to identify the connected MSD's IP address and to select the part information (for example, source type, and pump type). Touch **Settings > Configuration > Detectors**, then select the tab for the MSD. The MSD IP address entered here must exactly match the IP address entered in the data system and at the MSD keyboard.

Once the instruments have IP addresses and are connected to the LAN, complete the GC/MS configuration and enable enhanced communications, Parts Finder data, and MS-friendly features such as the MS Vent method as follows:

- 1 Select **Settings > Configuration > Detectors**.
- 2 If configuring a 5977B MSD, select **LCOMM** from the dropdown menu under Connection Type, and input the MSD's IP Address, Gateway, and Net Mask. Otherwise, select **DCOMM** and input the MSD's IP address.
- 3 Enter details for the MSD.

Step 15 Connect the external cables

In addition to the LAN cable as referenced in **“Connect GC to LAN, Local Computer, or Tablet”** on page 22, other cables may be installed for control of the GC’s automatic liquid sampler (ALS), connecting signal output to integrators, synchronizing the start and end of a run between various instruments, sensing conditions external to the GC, and controlling devices external to the GC.

Back panel connectors

The figure below shows the connectors on the back panel of the GC.

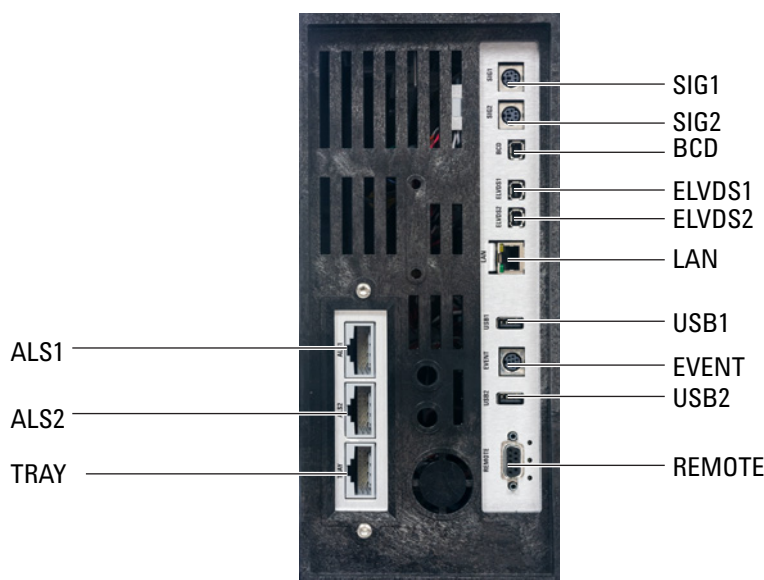

See also **“Cable Diagrams”** on page 77.

Sampler connectors

If using an ALS, connect it to the GC using the following connectors:

ALS 1 Optional. An injector or 150-position sample tray.

ALS 2 Optional. An injector or 150-Position sample tray.

TRAY Optional. The 150-position sample tray (includes optional barcode reader/heater/mixer control, if purchased).

The SIG (analog output) connectors

Optional. Use SIG1 and SIG2 for analog output signals.

REMOTE connector

Provides a port to remotely start and stop other instruments using the APG protocol. A maximum of 10 instruments can be synchronized using this connector. See **“Using the Remote Start/Stop Cable”** on page 70 for more detail.

EVENT connector

This connector provides two passive contact closures and two 24-volt outputs for controlling external devices. The outputs are controlled by valve drivers 5 through 8.

BCD input connector

This connector provides two control relays and a BCD input for a stream selection valve or a BCD generating device.

BCR/RA connector

This connector is reserved for the optional G3494B RS-232 Barcode Reader. Refer to the GC *Operation Manual*.

LAN connector

Standard Local Area Network (LAN) connector, for communication with data systems and other devices via TCP/IP.

Connecting cables

Use the supplied LAN cable to connect the GC to a LAN switch or hub as shown below in **Figure 12**. Other LAN configurations are possible. Refer to your Agilent data system documentation for details about its supported LAN configurations.

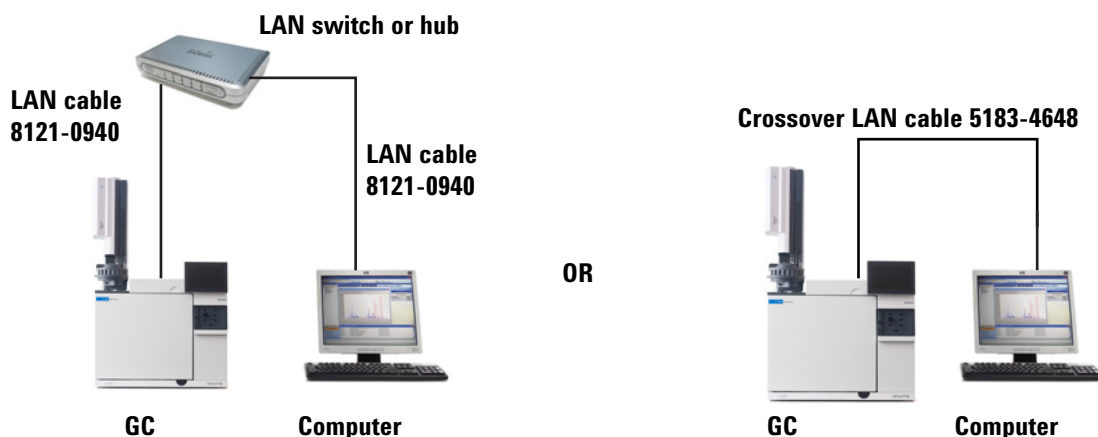

Figure 12. Simple supported LAN configurations: LAN switch or hub (left) and direct connection (right)

Table 7 Typical IP addresses for an isolated LAN

	GC	Computer
IP address	10.1.1.101	10.1.1.100
Subnet mask	255.255.255.0	255.255.255.0

1 Installing the GC

A single LAN communications cable is supplied with the GC. The switch (or hub) and other cables must be ordered separately, if needed. See [Table 8](#) and [Table 9](#) for cabling requirements for other configurations.

Table 8 Cabling requirements

8890 Series GC connected to:	Required Cable(s)	Part number
Samplers		
7693A Automatic Liquid Sampler	Injector cable or tray cable	G4514-60610
7650 Automatic Liquid Sampler	Injector cable	G4514-60610
7683 Automatic Liquid Sampler	Injector cable is integral Tray cable	G2614-60610
7697A Headspace Sampler	Remote, 9-pin male/6-pin connector	G1530-60930
G1289B/G1290B Headspace Sampler	Remote, 9-pin male/6-pin connector	G1530-60930
CTC automatic sampler	Cable, 4 conductor, remote start	G6500-82013
Mass Spectrometers and MS systems		
Mass Selective Detector	Remote, 2-m, 9-pin male/9-pin male	G1530-61200
GC / Agilent external sampler / MS or MSD system (for example, GC/HS/MSD or GC/Thermal Desorber/MSD)	Y-Cable, remote start/stop	G1530-61200
GC / TMS-9800/ MS or MSD system	Y-Cable, remote start/stop Interface cable for Agilent 6890/7890/8890 to P&T	G1530-61200 14-6689-086
Integrators		
3395B/3396C Integrator	Remote, 9 pin/15 pin Analog, 2 m, 6 pin	03396-61010 G1530-60570
Non-Agilent Integrator	General purpose analog signal cable 2 m, 6 pin	G1530-60560
Non-Agilent data system	General use remote, 9-pin male/spade lugs (various lengths)	35900-60670 (2 m), 35900-60920 (5 m), 35900-60930 (0.5 m)
Other devices		
Non-Agilent instrument, unspecified	External event, 8 pin/spade lugs	G1530-60590
Valco pulser module (used with PDHID)	Valve pulser module power supply cable (includes green EVENT label)	G1580-60730
Stream selection valves Gas sampling valves (external)	See documentation accompanying the valve External valve cable (includes green EVENT label)	 G1580-60710
LAN		
LAN	Cable, networking CAT 5, 25 feet Cable, LAN, crossover	8121-0940 5183-4648

Table 9 Cabling for other instruments in a 8890 Series GC system

Instrument 1	Instrument 2	Type of cable	Part number
Mass Selective Detector	Purge & trap, thermal desorber, or headspace sampler	Splitter (“Y”) cable for remote start/stop, 1 male and 2 female connectors	G1530-61200
		Splitter (“H”) cable for APG remote, 2 male and 2 female connectors	35900-60800

GC / MS / Agilent data system / ALS

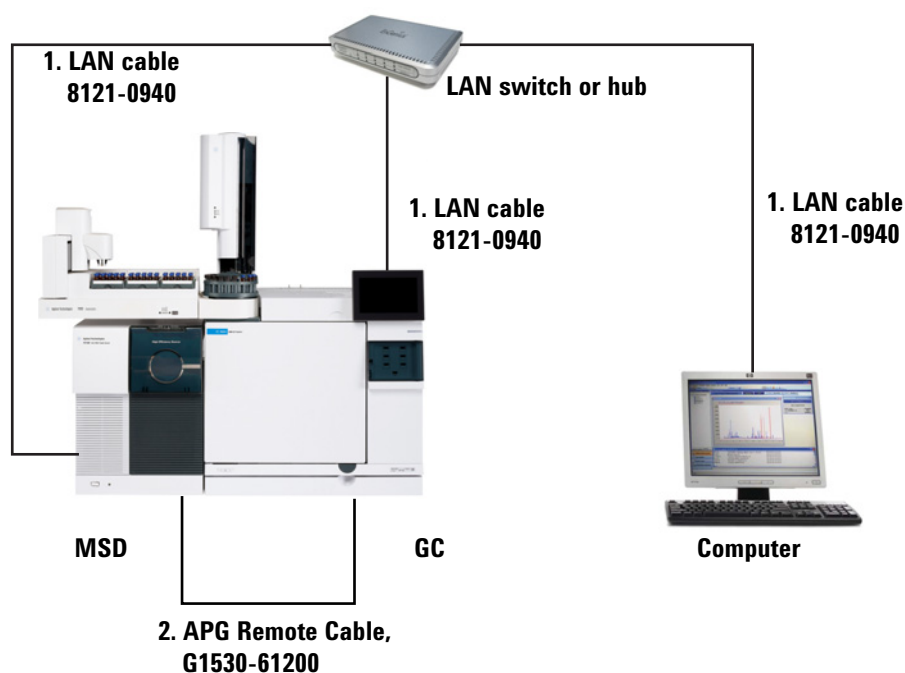

Table 10 Cables for a typical GC/MSD or GC/MS system

Number	Part number and description
1	G1530-61200, 2-m APG remote cable, 9-pin male/9-pin male
2	8121-0940, Cable, LAN, 25 foot

Additional cabling configurations

For additional cabling configurations, see [Appendix B](#), “Cabling Diagrams and Remote Start/Stop”.

Step 16 Vent ECD or uncombusted hydrogen to a fume hood

If using a ECD, or if using hydrogen carrier gas that will be uncombusted, you must either safely vent the exhaust or operate the GC inside a fume hood. For example, if using hydrogen carrier gas the GC would vent uncombusted hydrogen from a thermal conductivity detector (TCD) and from the inlet split vent and septum purge vent.

The ECD exhaust vents through a coiled tube. Connect tubing from the tube fitting at the end of this tubing to an exhaust hood via a hole in the back panel.

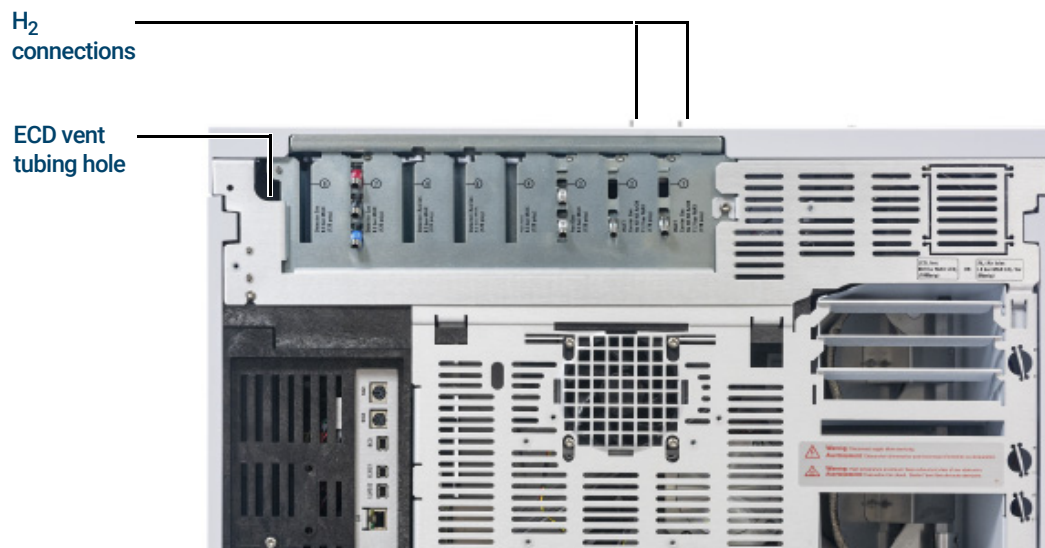

For a TCD, you must supply vent tubing and fittings to connect to the detector exhaust tube on the top of the detector. Route the tubing out the back of the GC, following the same path as for the ECD vent tubing.

The other detectors (FID and FPD) combust any hydrogen carrier gas.

Step 17 Connect cryogenic cooling (if present)

Cryogenic cooling allows you to cool the oven or inlet, including cooling to setpoints below ambient temperature. A solenoid valve controls the flow of coolant to the inlet or oven. The oven can use either liquid carbon dioxide (CO₂) or liquid nitrogen (N₂) as a coolant. All inlets except the multimode inlet must use the same coolant type as the oven. The multimode inlet can use a different coolant than configured for the oven, and can also use compressed air as a coolant.

CO₂ and N₂ coolants require different hardware on the GC. (You can use air cooling on a multimode inlet, with either the CO₂ or N₂ solenoid valves and hardware.)

Flared or AN tubing fittings are commonly used to connect the liquid supply tubing to the cryo coolant tank. Check with the supplier of the coolant before plumbing to be sure you have the correct fittings.

Connecting liquid carbon dioxide

WARNING

Do not use copper or thin-wall stainless steel tubing! Either presents an explosion hazard.

CAUTION

Do not use padded tanks for CO₂ supplies. The cryogenic valve is not designed to handle the higher pressures padded tanks generate.

The tank must be equipped with an eductor tube (dip tube) that reaches to the bottom of the tank, so that liquid (rather than gaseous) CO₂ is drawn.

Materials needed

- 1/8-inch heavy-wall, stainless steel tubing

Procedure

- 1 Locate the inlet for liquid CO₂ on the rear of the GC. Prepare enough tubing to reach from the supply tank to this fitting. See **Figure 13**.



Figure 13. Location of cryogenic cooling valve

- 2 Connect the supply tubing to the liquid CO₂ tank outlet with the fitting recommended by the supplier.
- 3 Use a Swagelok fitting to connect the supply tubing to the cryogenic valve inlet.

Connecting liquid nitrogen

Materials needed

- 1/4-inch insulated copper tubing

Procedure

- 1 Position the nitrogen tank as close to the GC as possible to insure that liquid and not gas is delivered to the inlet.
- 2 Locate the inlet for coolant on the rear of the GC. Prepare enough tubing to reach from the supply tank to this outlet. See [Figure 14](#).

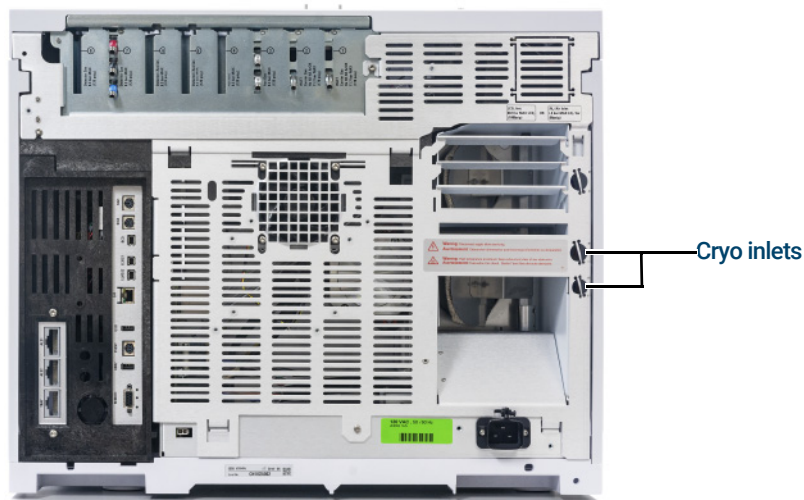

Figure 14. N₂ cryogenic cooling valve connections

- 3 Connect the supply tubing to the liquid N₂ tank outlet with the fitting recommended by the supplier.
- 4 Use a Swagelok fitting to connect the supply tubing to the cryogenic valve inlet.

Connecting air to the multimode inlet

The multimode inlet can also use compressed air cooling with the liquid N₂ inlet cooling option. Requirements for compressed air cooling:

- The compressed air should be free of particulate material, oil, and other contaminants. These contaminants could clog the inlet's cryo valve and expansion orifice or impact the proper operation of the GC.
- The required air supply pressure depends on the installed solenoid valve type. For a multimode inlet with N₂ cooling, set the air supply pressure to 138 to 276 kPa (20 and 40 psig).

While air supplied from tanks can meet these criteria, the consumption rate of air can be 80 L/min, varying based on supply pressure.

NOTE

A noise reduction kit, G3510-67001, is available for users of compressed air cooling with a multimode inlet.

Materials needed

Installation of a compressed air line to the inlet cryo coolant valve requires the hardware (and appropriate fittings) noted below:

- Use 1/4-inch copper or stainless steel tubing for supply tubing to the N₂ valve

1 Installing the GC

Procedure

- 1 Locate the input fitting for inlet coolant on the rear of the GC. Prepare enough tubing to reach from the supply to this outlet.
- 2 Connect the supply tubing to the air supply outlet with the fitting recommended by the supplier.
- 3 Use a Swagelok fitting to connect the supply tubing to the cryogenic valve input fitting.

Step 18 Connect valve actuator air (if present)

Valves are driven by air actuators. Valves should have a dedicated air source; they cannot share detector air supplies.

CAUTION

Do not share air between a detector and valves.

Valves can use nitrogen as an alternate supply. In this case, the nitrogen does not have to be chromatographic grade but must be free from contaminants.

Valve actuator air is supplied through 1/4-inch plastic tubing. If your GC was ordered with valves, the plastic tubing will already be attached to the actuators and will extend from the back of the GC. Additional valves are shipped with a 1/4 to 1/8-inch reducing union to be used in plumbing.

CAUTION

Route the tubing away from the oven exhaust. The hot air will melt the plastic tubing.

Turn off the air supply at the source. If needed, shorten the supplied plastic tubing using a sharp knife. Connect the tubing to the air source using a 1/4-inch Swagelok nut and ferrules. See [Figure 15](#).

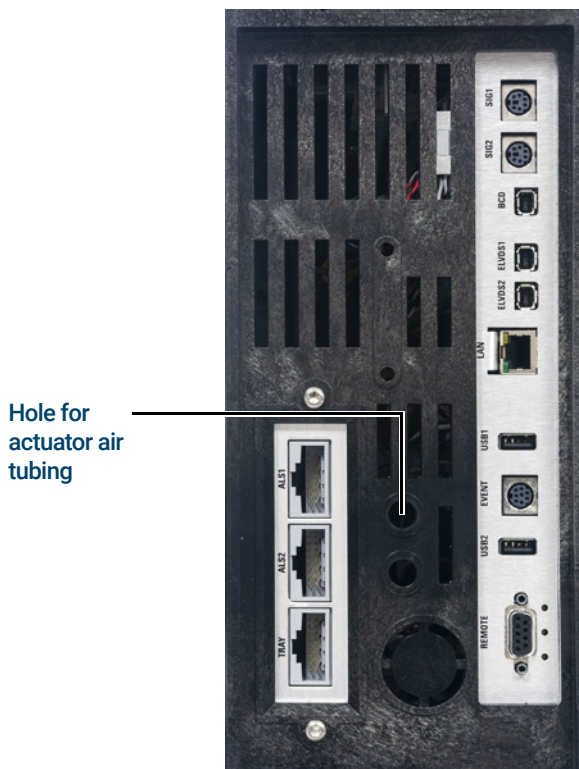

Figure 15. Valve actuator air tubing

Step 19 Configure Headspace Communications

The 7697 headspace sampler can be configured to communicate with the connected GC. This feature requires a HS with firmware A.01.06 (or greater). With communications configured, the HS knows GC method timings and programs, and can synchronize with the GC clock and follow the GC instrument schedule.

To configure GC-HS communications:

- 1 Select **Settings > Configuration > Headspace**.
- 2 Use this page to enter details for, and control, the headspace sampler.
- 3 Select **Apply**. The entered changes are saved to the GC.

If communications fails, check the IP addresses. Verify that the GC's IP address is correct in the headspace sampler, and that the headspace sampler's IP address is correct in the GC. Also check that both instruments are turned on and connected to the LAN. Verify all LAN cable connections.

After GC installation, complete HS configuration. Refer to the HS control software help and the HS manuals for information on the configuration options.

Step 20 Configure the checkout column

You must configure the consumable items (such as the checkout column).

If your checkout column has a Smart ID Key, Insert the key into one of the six Smart ID key slots on the front of the GC. Input which number column (1-6) the key corresponds to in the dialog that appears.

Checkout column

The column length, inside diameter, and film thickness are on a metal tag attached to the column.

- 1 Select **Settings > Configuration > Columns > Column #** to be configured and choose **Column Type**.
- 2 In the **Inlet connection** field, choose the Inlet to select a gas pressure control device for this end of the column. Selections include the installed GC inlets, and installed Aux and PCM channels.

The screenshot shows the 'Configuration' dialog box with a sidebar on the left containing a menu with options: ALS, Valves, Inlets, Columns (highlighted), Oven, Thermal Zones, Detectors, Analog Out, PSD EPCs, Aux EPCs, and Misc. The main area is titled 'Column 1 Settings' and has tabs for Column 1 through Column 6. The settings for Column 1 are as follows:

Field	Value
Column Type	Capillary
Thermal zone	Oven
Inlet connection	Inlet 1
Outlet connection	Detector 1
Length	30.00 m
Diameter	320.00 µm
Film Thickness	0.25 µm

- 3 In the **Length** field, type the column length, in meters.
- 4 In the **Diameter** field, type the column inside diameter in microns.
- 5 In the **Film thickness** field, type the film thickness in microns. The column is now defined.
- 6 In the **Outlet connection** field, select a gas pressure control device for this end of the column. Selections include the installed Aux and PCM channels, and detectors. When a detector is selected, the outlet end of the column is controlled at 0 psig for the FID, TCD, FPD, NPD, and ECD or vacuum for the MSD.

1 Installing the GC

- 7 Select the **Thermal zone**. In most cases this will be **GC oven**, but you may have an MSD transfer line heated by an auxiliary zone, valves in a separately-heated valve box or other configurations.

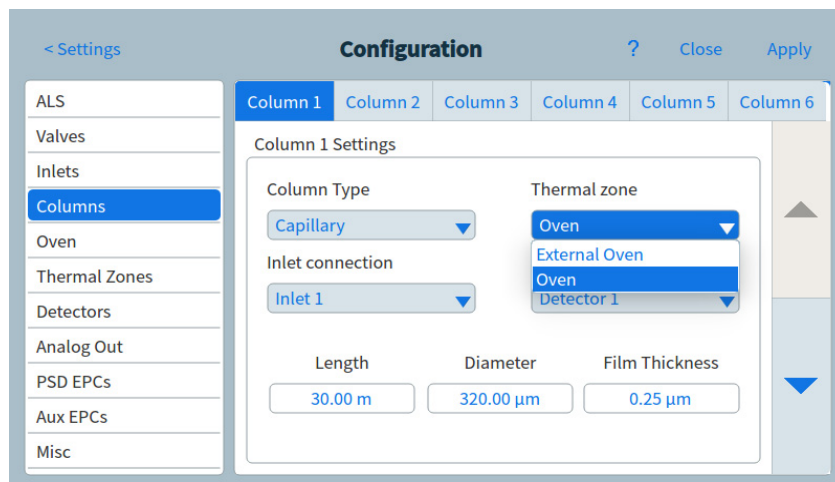

The screenshot shows the 'Configuration' window for 'Column 1'. On the left is a sidebar menu with options: ALS, Valves, Inlets, Columns (selected), Oven, Thermal Zones, Detectors, Analog Out, PSD EPCs, Aux EPCs, and Misc. The main area is titled 'Column 1 Settings' and contains the following fields:

- Column Type: Capillary
- Thermal zone: Oven (dropdown menu is open, showing options: Oven, External Oven, Oven, Detector 1)
- Inlet connection: Inlet 1
- Length: 30.00 m
- Diameter: 320.00 µm
- Film Thickness: 0.25 µm

- 8 Press **Apply**.

This completes configuration for a single capillary column. Also see the Operation manual for more information about configuring columns.

Step 21 Install the checkout column

A capillary column was shipped with the GC to be used to confirm proper operation. Agilent suggests that it be used only for that purpose.

Before use, the column must be conditioned to remove any contaminants.

- 1 Locate the installation instructions for the column, inlet, and detector you will use. Refer to the *Maintaining Your GC* manual. See to the sections on your specific inlet and detector types:
- 2 Install the column in the inlet.
- 3 Connect the free end of the column to the detector, as described in *Maintaining Your GC*.
- 4 Turn on the carrier gas.
- 5 If using a split/splitless or multimode inlet, perform an Inlet Leak Check. Select **Diagnostics > Diagnostic Test**, select **Inlet #**, then select **Leak & Restriction Test**. Press **Start Test** to begin the check. If the check fails, tighten connections.

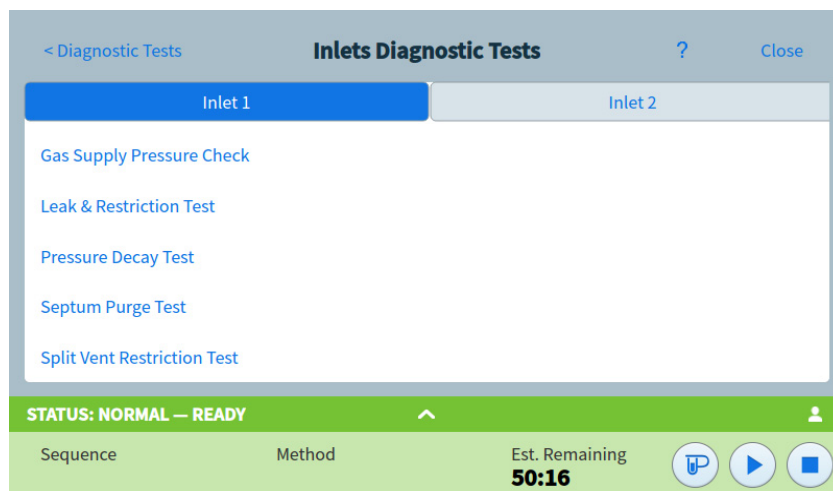

1 Installing the GC

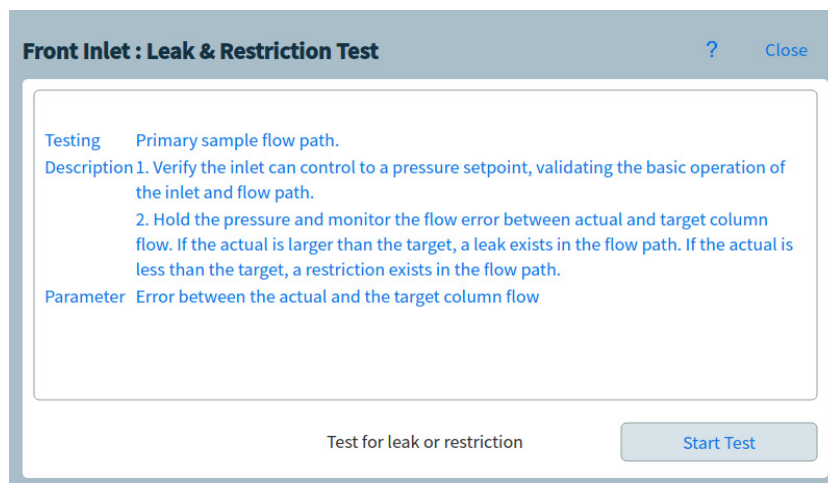

- 6 Set the oven temperature and inlet flow conditions specified for conditioning the column. Select **Method** to access current GC temperatures and flows.
 - Set the oven temperature to 20 °C higher than the highest checkout method temperature (do not exceed the column maximum temperature). For example, for FID checkout set the oven temperature to 210 °C.
 - Set the detector temperature to 20 °C higher than the checkout method temperature. For example, for FID checkout set the detector temperature to 320 °C.
- 7 Turn the detector gases on. Light the flame, if appropriate.
- 8 Heat the detector to the temperature given in the bakeout instructions, and hold at temperature for the time given in the instructions.

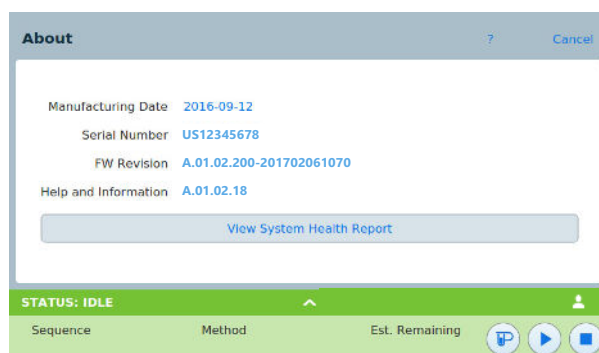
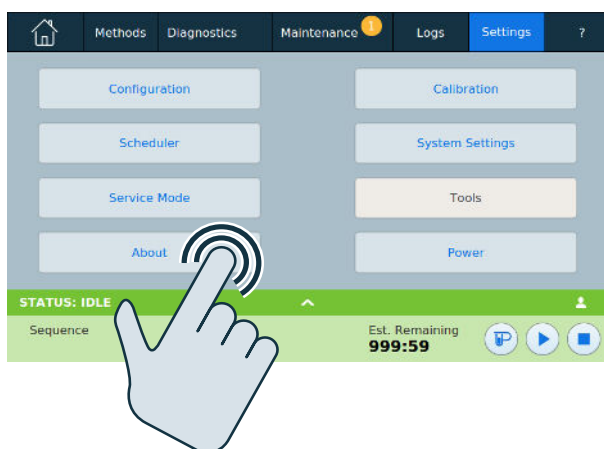

Step 22 Transfer the checkout sample to a screw-top sample vial

- 1 The checkout sample is contained in sealed glass vials. Wrap a piece of cloth or a paper towel around the vial to protect your fingers and snap the top off.

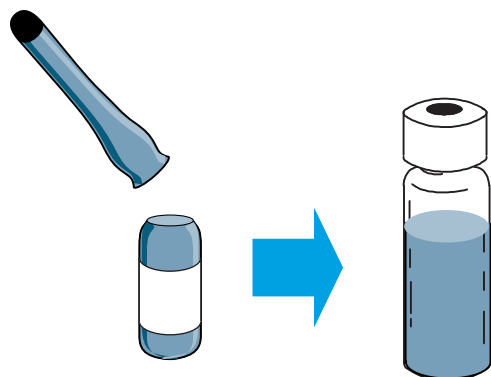

- 2 Use a pipette to transfer the sample to a 2-mL screw-top vial. (If using an ALS, use a vial suitable for the ALS turret or tray, as applicable.)

Step 23 When the system stabilizes, run one injection

Perform the checkout procedure as described in the *Operation Manual*.

- 1 Enter the parameters for the checkout procedure.
 - If using an Agilent data system, use it to create a checkout method.
 - If not using a data system, enter the setpoints using the GC touchscreen or the Browser Interface.
- 2 When the GC is ready to begin a run, the Touchscreen status shows **STATUS: NORMAL READY** (alternately, when the component of the GC is not ready to begin a run, the touchscreen shows **STATUS: NOT READY**), make the injection and start the run.

For a manual injection, inject the sample and press **Prep Run** .



- 3 Evaluate results by comparing the chromatogram you generated with the one in the checkout procedure. There should be a close resemblance.

Step 24 Prepare for the Next Analysis

After evaluating the GC under the checkout conditions, installation checkout is complete. The next step is to prepare the GC for your next analysis. Be sure to cool the GC before making changes.

- 1 Cool all heated zones to < 40 °C, and set safe gas flows. Place the GC in maintenance mode: **Maintenance > Instrument > Perform Maintenance > Maintenance Mode > Start Maintenance** and wait for the GC to become ready.
- 2 Turn off the power by pressing the **On/Off** switch.
- 3 Shut off all gas valves at the gas source.
- 4 If you are using cryogenic cooling, shut off the cryo coolant valve at the source.
- 5 When the GC is cool, do the following:
 - Install the appropriate inlet hardware (can include septum, liner, liner-O-ring, inlet gold seal, inserts, and so on).
 - Install the appropriate detector hardware (wavelength filter for FPD+, jet for FID or NPD).
 - Change to any alternate gas sources as needed for the new analysis.
 - Install the desired column and condition it per the manufacturer's recommendations.
 - Configure the GC to match any hardware or gas type changes (columns, liners, carrier or makeup gas types, and so on).
 - Load or create the desired method.

A

Making Swagelok Connections

Making Swagelok Connections 64

Using a Swagelok Tee 67

The gas supply tubing is attached with Swagelok fittings. If you are not familiar with Swagelok connections, review the following procedures.

Making Swagelok Connections

Objective

To make a tubing connection that does not leak and that can be taken apart without damaging the fitting.

Materials needed

- 1/8-inch (or 1/4-inch, if used) preconditioned copper tubing
- 1/8-inch (or 1/4-inch, if used) Swagelok nuts
- Front and back ferrules
- Two 7/16-inch (for 1/8-inch nuts) or 9/16-inch (for 1/4-inch nuts) wrenches

Procedure

- 1 Place a Swagelok nut, back ferrule, and front ferrule on the tubing as shown in **Figure 16**.

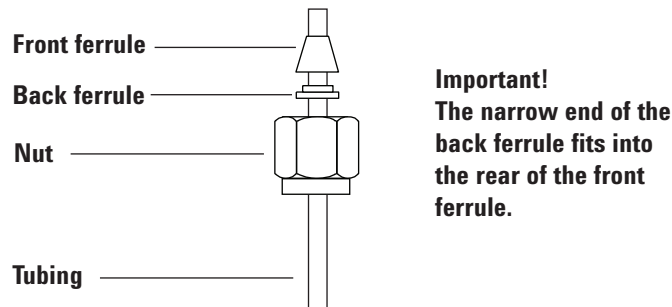

Figure 16. Swagelok nuts and ferrules

- 2 Push the tubing into the stainless steel fitting.
- 3 Make sure that the front ferrule is fully engaged. Slide the Swagelok nut over the ferrule and thread it onto the plug.
- 4 Push the tube fully into the plug, then withdraw it approximately 1 to 2 mm. See **Figure 17**.

A Making Swagelok Connections

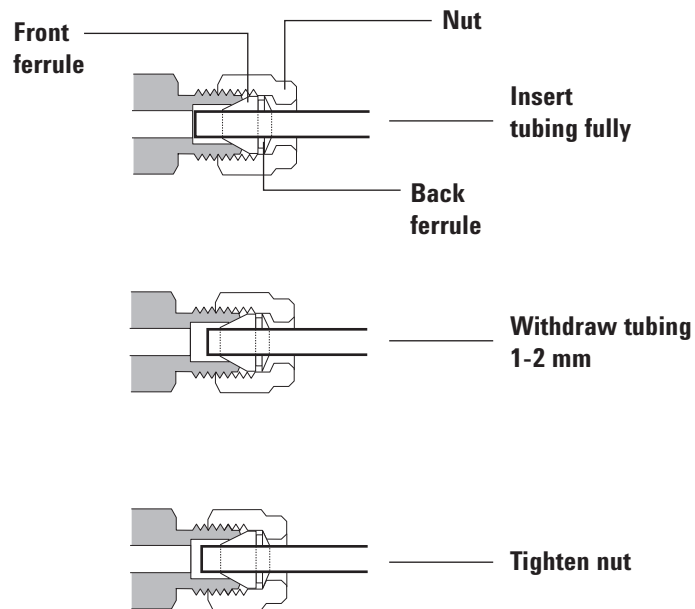

Figure 17. Insert the tubing

- 5 Finger-tighten the nut.
- 6 Mark the nut with a pencil line. See [Figure 18](#).

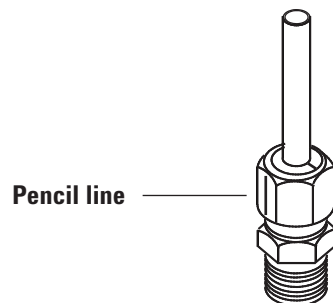

Figure 18. Marking the fitting

- 7 For 1/8-inch Swagelok fittings, use a pair of wrenches to tighten the fitting 3/4 of a turn. See [Figure 19](#).

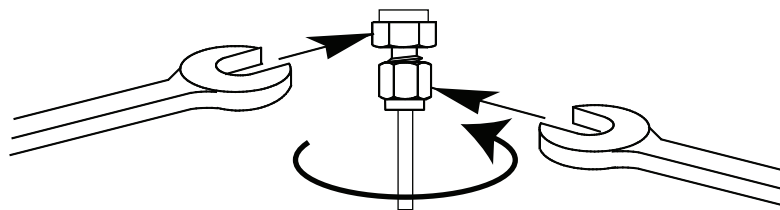

Figure 19. Final tightening

- 8 Remove the plug from the fitting. To connect the tubing, with nut and ferrules, to another fitting, finger-tighten the nut, then use a wrench to tighten it 3/4 (1/8-inch fittings) of a turn.

A Making Swagelok Connections

- Both correctly and incorrectly swaged connections are shown in **Figure 20**. Note that the end of the tubing in a correctly swaged fitting is not crushed and does not interfere with the action of the ferrules.

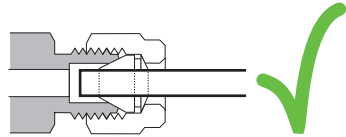
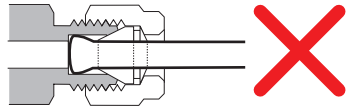

Figure 20. Completed fitting

Using a Swagelok Tee

To supply gas from a single source to more than one input, use a Swagelok Tee.

NOTE

Do not combine valve actuator air with flame ionization air. The valve action will cause major upsets in the detector signal.

Materials needed:

- 1/8-inch preconditioned copper tubing
- Tubing cutter
- 1/8-inch Swagelok nuts and front and back ferrules
- 1/8-inch Swagelok Tee
- Two 7/16-inch wrenches
- 1/8-inch Swagelok cap (optional)

- 1 Cut the tubing where you want to install the Tee. Connect the tubing and Tee with a Swagelok fitting. See **Figure 21**.

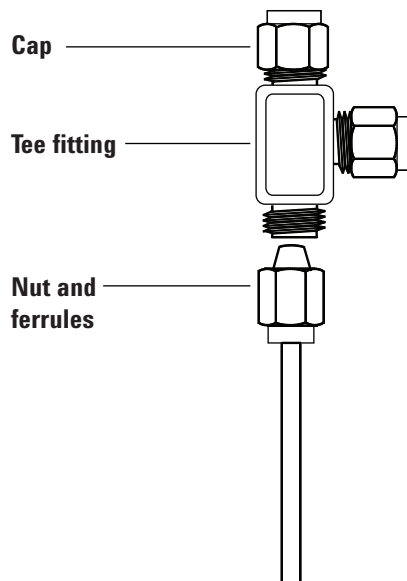

Figure 21. Swagelok tee

- 2 Measure the distance from the Tee to the instrument fittings. Attach copper tubing to the open Tee ends with Swagelok fittings.

B Cabling Diagrams and Remote Start/Stop

Using the Remote Start/Stop Cable 70

Multi-instrument Cabling Examples 73

Cable Diagrams 77

This section lists cabling requirements and connection diagrams that apply to less common or specialized GC installations.

Using the Remote Start/Stop Cable

Remote start/stop is used to synchronize two or more instruments. For example, you might connect an integrator and the GC so that the Start/Stop buttons on either instrument control both of them. You can synchronize a maximum of ten instruments using Remote cables.

Connecting Agilent products

If connecting two Agilent products with Remote cables, the sending and receiving circuits will be compatible—just plug in both ends of the cable.

Connecting non-Agilent products

If connecting to a non-Agilent product, the following paragraphs contain information you will need to ensure compatibility.

APG Remote signal electrical specifications

The APG signals are a modified open collector type. The signal levels are generally TTL levels (low voltage is logic zero, high voltage is logic one) but the open circuit voltage will be between 2.5 and 3.7 V. The typical voltage is 3 V. A voltage over 2.2 V will be interpreted as a high logic state while a voltage below 0.4 V will be interpreted as a low logic state. These levels provide some margin over the specifications of the devices used.

The pull-up resistance, connected to the open-circuit voltage, is in the range of about 1 kOhms to 1.5 kOhms. For a logic-low state, for a single device on the bus, the minimum current you must be able to sink is 3.3 mA. Since devices are connected in parallel, when you have multiple devices this minimum current must be multiplied by the number of devices attached on the bus. The maximum voltage for a low-input state is 0.4 V.

The bus is passively pulled high. Leakage current out of a port must be less than 0.2 mA to keep the voltage from being pulled lower than 2.2 V. Higher leakage current may cause the state to be interpreted as a low.

Over-voltage protection: APG Remote connections are clamped by a zener diode to 5.6 V. Exceeding this voltage will damage the circuit (GC logic board).

APG Remote - Suggested drive circuits

A signal on the APG bus may be driven by another APG device or by one of the following circuits:

- A relay, with one side connected to ground, when closed will set a logic-low state.
- An NPN transistor, with the emitter connected to ground and the collector connected to the signal line will set a logic-low state if proper base current is supplied.
- An open-collector logic gate will perform this same function.
- A low-side drive IC will also work, but Darlington-type drivers should be avoided as they will not meet the low-side voltage requirement of less than 0.4 V

APG Remote connector

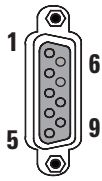

Pin	Function	Logic
1	Digital ground	
2	Prepare	LOW true
3	Start	LOW true (output)
4	Start relay	
5	Start relay	
6	Not used	
7	Ready	HIGH true (output)
8	Stop	LOW true
9	Not used	

APG Remote signal descriptions

Prepare (Low True) Request to prepare for analysis. Receiver is any module performing pre-analysis activities. For example, shorting pin 2 to ground will put the GC into Prep Run state. This is useful for Splitless Mode to prepare the inlet for injection or when using Gas Saver. This function is not needed by Agilent autosampler systems.

Ready (High True) If the Ready line is high (> 2.2 VDC) then the system is ready for next analysis. Receiver is any sequence controller.

Start (Low True) Request to start run/timetable. Receiver is any module performing runtime-controlled activities. The 8890 Series GC requires a pulse duration of at least 500 micro-seconds to sense a start from an external device.

Start Relay (Contact Closure) A 120 millisecond contact closure used as an isolated output to start another device that is not compatible or connected with APG Remote pin 3.

Stop (Low True) Request to reach system ready state as soon as possible (for example, stop run, abort or finish, and stop injection). Receiver is any module performing runtime-controlled activities. Normally this line is not connected, if the GC oven program is used to control the method Stop time.

APG Remote timing diagram

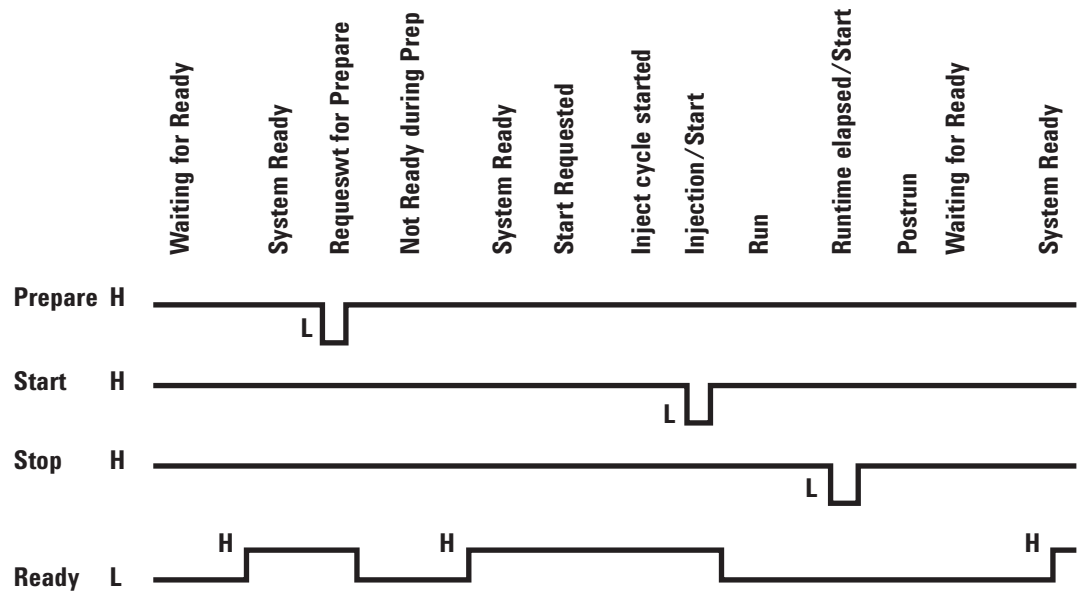

Multi-instrument Cabling Examples

GC / ALS / Non-Agilent Data System

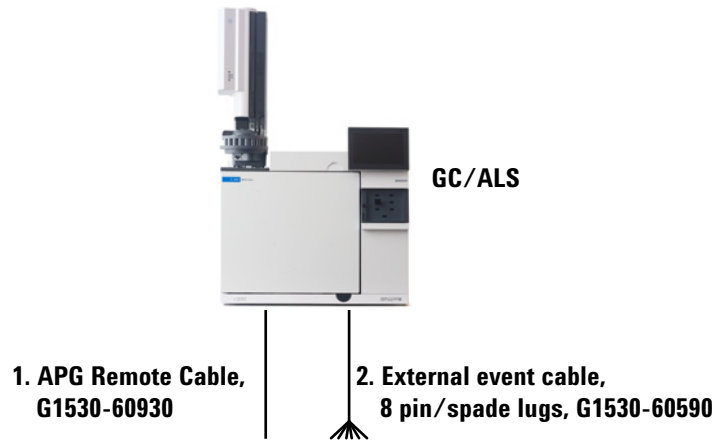

Number	Part number and description
1	G1530-60930, General use APG remote cable, 9-pin male/spade lug (0.5m)
2	G1530-60590, External event cable, 8-pin/spade lugs

35900-60670 APG remote cable spade lug identification			G1530-60590 External event cable spade lug identification		
Connector 1 9 pin (male)	Signal name	Connector 2 spade lugs	Pin	Color	Signal
1	GND	Black	1	Yellow	24 V Out
2	Prepare	White	2	Black	24 V Out 2
3	Start	Red	3	Red	Ground
4	Shut down	Green	4	White	Ground
5	Reserved	Brown	5	Orange	Contact 1
6	Power on	Blue	6	Green	Contact 1
7	Ready	Orange	7	Brown	Contact 2
8	Stop	Yellow	8	Blue	Contact 2
9	Start Request	Violet	9		

GC / 3395A/3396B Integrator / ALS

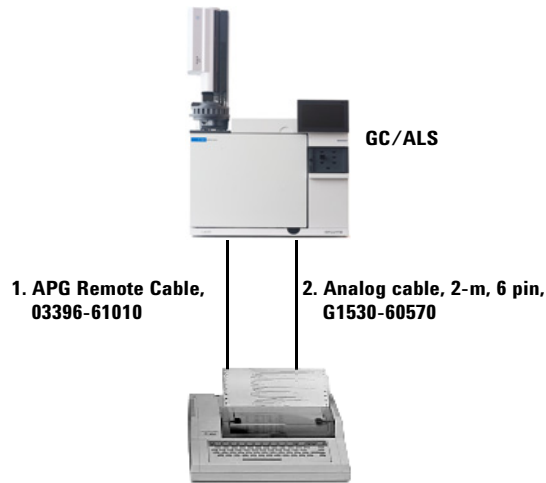

Number	Part number and description
1	03396-61010, 2-m APG remote cable, 9-pin/15-pin
2	G1530-60570, 2-m Analog cable, 6-pin

GC / 3396C Integrator / ALS

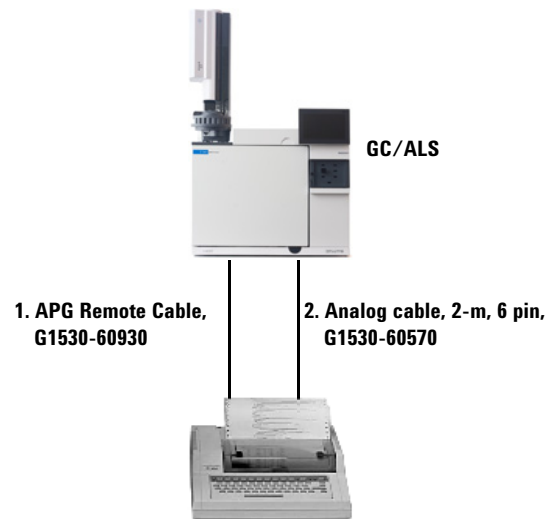

Number	Part number and description
1	G1530-60930, 2-m APG remote cable, 9-pin male/9-pin male
2	G1530-60570, 2-m Analog cable, 6-pin

Example: Using a Y-Cable in a setup (GC/MSD/Data System/Headspace Sampler)

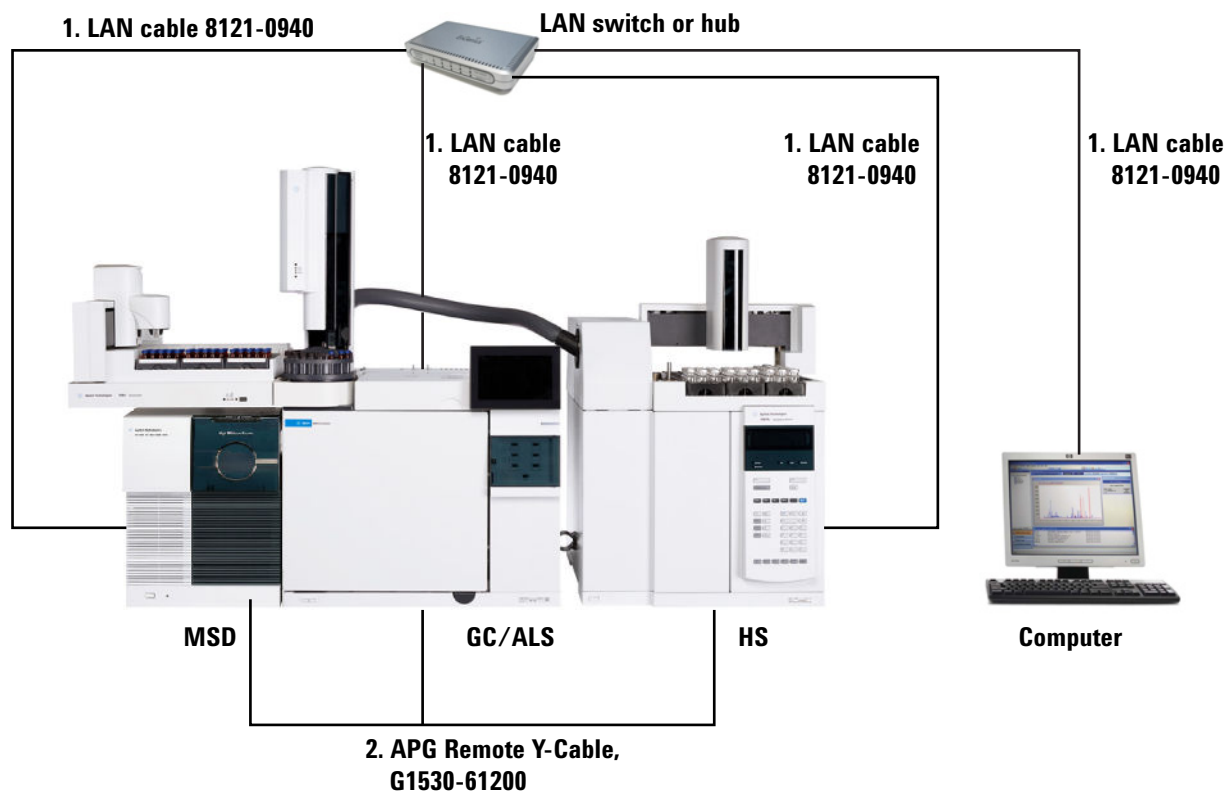

Number	Part number and description
1	8121-0940, Cable, LAN, 25 foot
2	G1530-61200, 2-m Y-cable, remote start/stop

GC / External Events (unspecified, non-Agilent instrument)



1. External event cable,
8 pin/spade lugs,
G1530-60590

Number	Part number and description
1	G1530-60590, External events cable, 8-pin/spade lugs

Connector	Signal name	Maximum rating	Wire color	Corresponds to valve #
24 volt control output				
1	24 volt output 1	150 mA output	Yellow	5
2	24 volt output 2	150 mA output	Black	6
3	Ground		Red	
4	Ground		White	
Relay contact closures (normally open)				
5	Contact closure 1	48 V AC/DC, 250 mA	Orange	7
6	Contact closure 1		Green	7
7	Contact closure 2	48 V AC/DC, 250 mA	Brown or violet	8
8	Contact closure 2		Blue	8

Cable Diagrams

Analog signal cable, general use, G1530-60560

Connects GC signal outputs to non-Agilent products. Also used for the Analog Input Board (AIB).

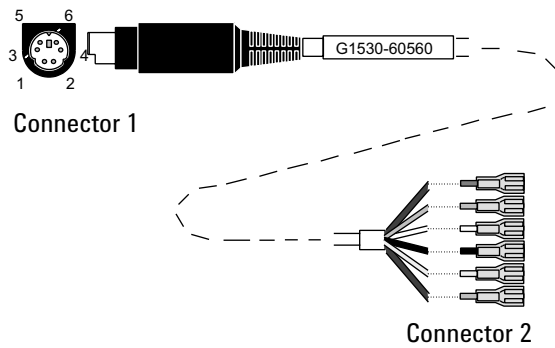

The pin assignments for the general use analog out cable are listed in [Table 11](#).

Table 11 Analog cable, general use, output connections

Connector 1	Connector 2, wire color	Signal
1	Brown or violet	Not used
2	White	0 to 1 V, 0 to 10 V (-)
3	Red	Not used
4	Black	1 V (+)
6	Blue	10 V (+)
Shell	Orange	Ground

Agilent analog signal cable, G1530-60570

This cable connects an Analog out port to an external data system. Both 0 to 1 volt and 0 to 10 volts are provided. Connects both GC signal outputs to Agilent 3395B/3396C integrators, and the 35900 A/D.

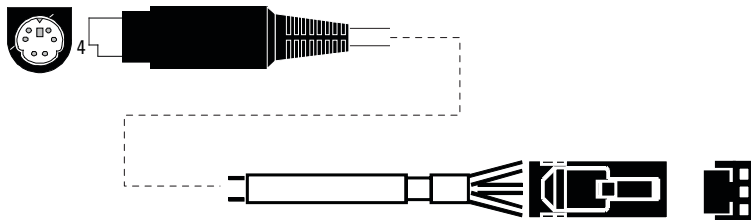
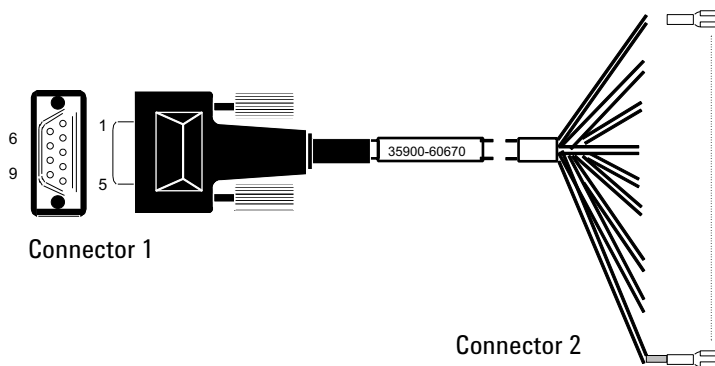

Figure 22. Analog output cable to an Agilent product

Remote start/stop cable, general use, 35900-60670



The pin assignments for the remote start/stop cable are listed in [Table 12](#).

Table 12 Remote start/stop cable connections

Connector 1, 9-pin male	Connector 2, wire color	Signal
1	Black	Digital ground
2	White	Prepare (low tone)
3	Red	Start (low tone)
4	Green	Start relay (closed during start)
5	Brown	Start relay (closed during start)
6	Blue	Open circuit
7	Orange	Ready (high true input)
8	Yellow	Stop (low tone)
9	Violet	Open circuit

Agilent APG remote start/stop cable, 03396-61010

Synchronizes the GC with an Agilent integrator. Additional cables may be used to add more instruments (up to 10 total).

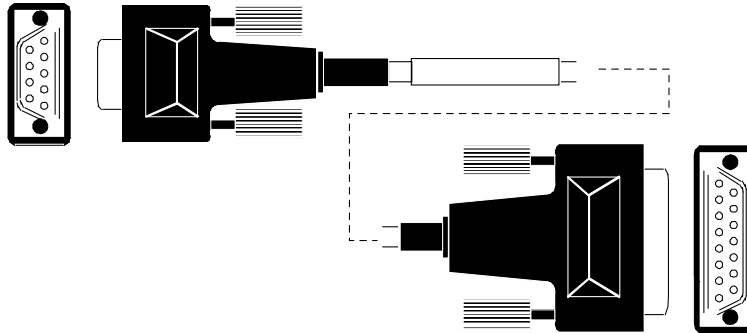

Figure 23. Remote start/stop cable, GC to Agilent integrator

Agilent APG remote start/stop cable, G1530-60930

Synchronizes the GC with another Agilent instrument. Additional cables may be used to add more instruments (up to 10 total).

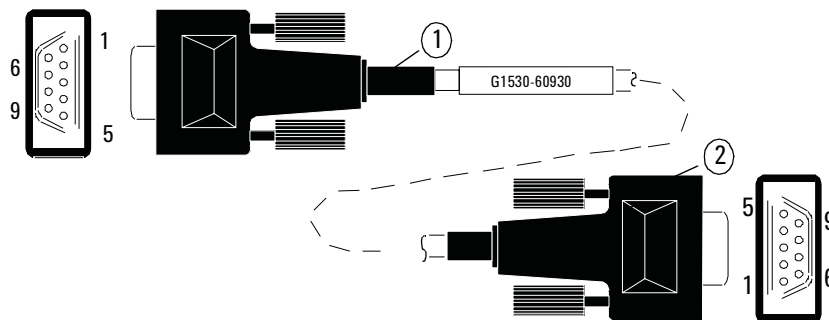

Figure 24. Remote start/stop cable, GC to Agilent instrument

Agilent remote start/stop Y-cable, G1530-61200

Synchronizes the GC with another 2 Agilent instruments.

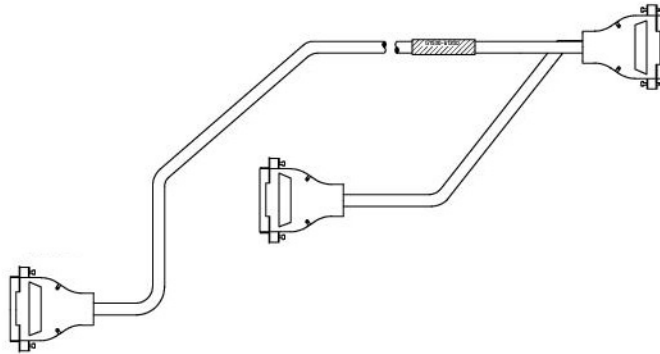

Figure 25. Remote start/stop cable, GC to Agilent instrument

BCD cable, G3450-60570

The BCD cable connector has eight passive inputs that sense total binary-coded decimal levels. The pin assignments for this connector are listed in [Table 13](#).

Table 13 BCD cable connections

Connector 1 Pin	Connector 2 Pin	Ribbon Cable Wire Color
	1	Brown
	2	Red
1	3	Orange
	4	Yellow
	5	Green
	6	Blue
	7	Violet
	8	Gray
	9	White
2,8	10	Black
	11	Brown
6	12	Red
	13	Orange
5	14	Yellow
	15	Green
4	16	Blue
7	17	Violet
3	18	Gray

Table 13 BCD cable connections (continued)

Connector 1 Pin	Connector 2 Pin	Ribbon Cable Wire Color
	19	White
	20	Black
	21	Brown
	22	Red
	23	Orange
	24	Yellow
	25	Green
	26	Blue

External event cable, G1530-60590

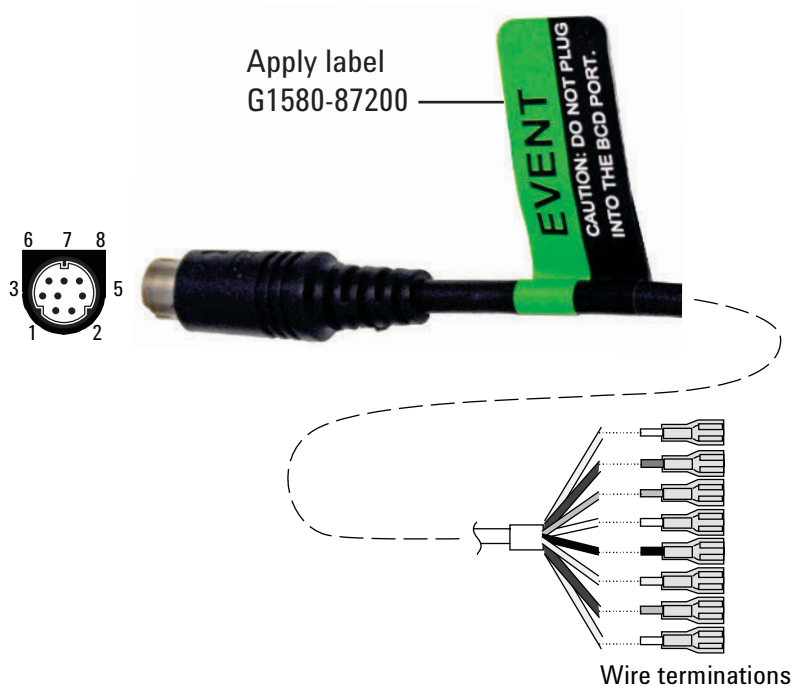

The external event cable has two passive relay contact closures with two 24-volt control outputs. Devices connected to the passive contact closures must be connected to their own power sources.

The pin assignments for this cable are listed in [Table 14](#).

Table 14 External events cable

Connector 1 pin	Signal name	Maximum rating	Connector 2, wire color	Controlled by valve #
24 volts output				
1	24 V output 1	150 mA	Yellow	5

Table 14 External events cable (continued)

Connector 1 pin	Signal name	Maximum rating	Connector 2, wire color	Controlled by valve #
2	24 V output 1	150 mA	Black	6
3	Ground		Red	
4	Ground		White	
Relay contact closures (normally open)				
5	Closure 1	48 V AC/DC, 250 mA	Orange	7
6	Closure 1		Green	7
7	Closure 2	48 V AC/DC, 250 mA	Brown or violet	8
8	Closure 2		Blue	8

When used for external event control, apply label G1580-87200 to identify the cable for EVENT use.

External valve cable, G1580-60710

Supplies power for certain valve applications.

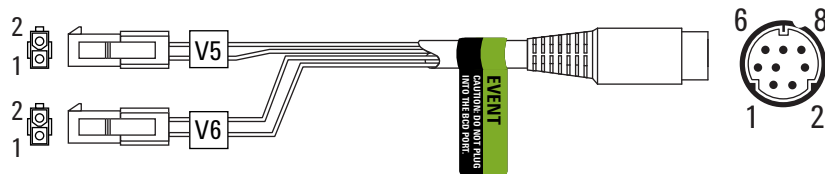

Connector 1 pin	Wire color	Connector and pin	Function
1	Yellow	V5 pin 1	24 V, 150 mA max.
2	Black	V6 pin 1	24 V, 150 mA max.
3	Red	V5 pin 2	Ground
4	White	V6 pin 2	Ground
5			
6			
7			
8			

Pulser module power supply cable, G1580-60730

Supplies power for a PDHID pulser module.

B Cabling Diagrams and Remote Start/Stop

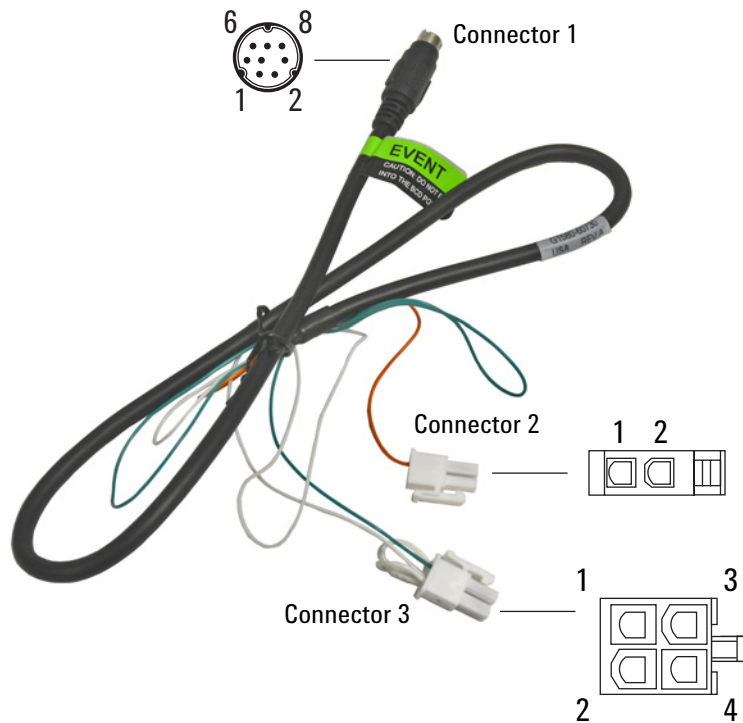

Connector 1 pin	Wire color	Connector and pin	Function
1	Yellow		
2	Black		
3	Red		
4	White	Connector 3 pin 1*	Ground
5	Orange	Connector 2 pin 1	Contact closure 1, 48 V AC/DC, 250 mA
6	Green	Connector 3 pin 3	Contact closure 1
7	Brown		
8	Blue		

* Connector 3: Pin 1 is jumpered to pin 2. Pin 2 is jumpered to pin 4.

This page intentionally left blank.

www.agilent.com

© Agilent Technologies, Inc. 2019

Second edition, December 2019



G3540-90013

