

Agilent 8890 Gas Chromatograph
Operation Manual



Notices

© Agilent Technologies, Inc. 2020

No part of this manual may be reproduced in any form or by any means (including electronic storage and retrieval or translation into a foreign language) without prior agreement and written consent from Agilent Technologies, Inc. as governed by United States and international copyright laws.

Manual Part Number

G3540-90014

Edition

Third edition, January 2020

Second edition, July 2019

First edition, January 2019

Printed in USA or China

Agilent Technologies, Inc.
2850 Centerville Road
Wilmington, DE 19808-1610 USA

Agilent Technologies, Inc.
412 Ying Lun Road
Waigaoqiao Freed Trade Zone
Shanghai 200131 P.R.China

Warranty

The material contained in this document is provided "as is," and is subject to being changed, without notice, in future editions. Further, to the maximum extent permitted by applicable law, Agilent disclaims all warranties, either express or implied, with regard to this manual and any information contained herein, including but not limited to the implied warranties of merchantability and fitness for a particular purpose. Agilent shall not be liable for errors or for incidental or consequential damages in connection with the furnishing, use, or performance of this document or of any information contained herein. Should Agilent and the user have a separate written agreement with warranty terms covering the material in this document that conflict with these terms, the warranty terms in the separate agreement shall control.

Safety Notices

CAUTION

A CAUTION notice denotes a hazard. It calls attention to an operating procedure, practice, or the like that, if not correctly performed or adhered to, could result in damage to the product or loss of important data. Do not proceed beyond a CAUTION notice until the indicated conditions are fully understood and met.

WARNING

A WARNING notice denotes a hazard. It calls attention to an operating procedure, practice, or the like that, if not correctly performed or adhered to, could result in personal injury or death. Do not proceed beyond a WARNING notice until the indicated conditions are fully understood and met.

Contents

1 Getting Started

The 8890 Gas Chromatograph	12
Before Operating Your GC	13
Chromatography Using a GC	14
Inlets	15
Automatic injectors	15
Automatic sampling valves	15
GC Columns and Oven	16
Detectors	17
Touchscreen	18
System Operation	20
Touchscreen	20
Browser Interface	21
Data System	21
Browser Interface	23
Status Indicator	27
GC Status	28
Alert tones	28
Error conditions	28
Clearing a shutdown condition	28
Overview of Running a Sample	29
Instrument Control	30
Correcting Problems	31

2 Help and Information

Where to Find Information	34
Help from the Touchscreen	35
Touchscreen Help	36
Help from a Browser	39
Context-Sensitive Help	43
Agilent GC and GC/MS User Manuals & Tools DVD	45

3 Startup and Shutdown

- To Start Up the GC **48**
- To Shut Down the GC for Less Than a Week **49**
- To Shut Down the GC for More Than a Week **50**

4 Touchscreen Operation

- Navigation **52**
 - Run controls **53**
 - Status/control tray **54**
- Entering Data **55**
- Home View **56**
 - Flow path page **57**
 - Status page **57**
 - Plot page **58**
- Methods View **61**
- Diagnostics View **62**
- Maintenance View **63**
- Logs View **64**
- Settings View **65**
- Help Menu **66**
- Touchscreen Functionality When the GC Is Controlled by an Agilent Data System **67**

5 Methods

- What is a Method? **70**
- What Is Saved in a Method? **71**
- What Happens When You Load a Method? **72**
- Editing the Active Method **73**
 - To edit the active method **73**
 - GC hardware changes **73**
- Create a Method **74**
- Load a Method **75**
- Running Methods **76**
 - Pre Run and Prep Run **76**
 - Manually prepare for the run **76**

To manually inject a sample with a syringe and start a run	76
To run a method to process a single ALS sample	77
To abort a method	77
Events	78
Using run time events	78
Programming run time events	79
The run table	79
Editing events in the run table	79
Deleting run time events	79
Inlets	80
Carrier gas flow rates	80
About gas saver	81
To set the PTV or COC coolant parameters	81
To set MMI coolant parameters	82
About Oven Temperature Programming	84
Oven ramp rates	84
Oven cryogenic cooling parameters	85
Columns	87
Nickel Catalyst Tube	88
About the nickel catalyst tube	88
Detectors	89
FID	89
FPD+	90
NPD	91
TCD	93
ECD	94
Valves	95
The valve box	95
Valve control	95
Valve types	97
Controlling a valve	97
GC Output Signals	101
Analog signals	101
Digital signals	103
Column compensation	106
Test plot	107

6 Sequences

What is a Sequence? **110**

Recoverable Errors **111**

7 Diagnostics

About Diagnostics **114**

The system health report **114**

Automated testing **115**

Self-guided diagnostics **115**

Using the Diagnostics View **117**

Performing Diagnostic Tests **118**

8 Maintenance

Early Maintenance Feedback (EMF) **122**

Counter types **122**

Thresholds **122**

Default Thresholds **123**

Perform Maintenance **124**

Available Counters **125**

Viewing Maintenance Counters **128**

To Enable, Reset, or Change a Limit for an EMF Counter **129**

EMF Counters for Autosamplers **130**

Counters for 7693A and 7650 ALS with EMF-enabled firmware **130**

Counters for ALS with earlier firmware **130**

EMF Counters for MS Instruments **131**

9 Logs

Logs View **134**

Maintenance logs **135**

Run log **135**

System log **135**

10 Settings

About Settings **138**

Service Mode **139**

About **141**

Calibration **142**

Maintaining EPC calibration—inlets, detectors, PCM, PSD, and AUX **142**

To zero a specific flow or pressure sensor **143**

System Settings **145**

Configuring the IP address for the GC **145**

To set system date and time **147**

To change the system locale **148**

To set system power saving features **149**

To access stored run data **150**

To control Browser Interface access **150**

To run the system setup routine **151**

Tools **153**

Performing a column compensation run **153**

Power **155**

11 Configuration

About Configuration **158**

Configuration Changes **159**

Configure a new device **159**

Configure an existing device **159**

Valve Configuration **161**

To configure valves **161**

Inlet Configuration **163**

Columns **165**

To configure a single column **166**

To configure a packed column **167**

To configure a composite column **167**

Additional notes on column configuration **169**

To configure multiple columns **169**

Inlets and outlets **170**

A simple example **170**

Slightly more complex example **171**

Oven **172**

To configure the oven **172**

Detector Configuration **174**

Analog Output Settings **175**

MSD Configuration	176
System-level communications	176
MSD configuration	176
GC/MS systems	177
To enable or disable MS communications	179
To use the GC when the MS is shut down	179
Headspace Sampler	180
Headspace sampler configuration	180
System-Level communications	180
To enable or disable HS communications	181
Miscellaneous Settings	182
Readiness	183
LTM Columns	184
Valve Box	185
PCMs	186
Aux EPCs	187

12 Resource Conservation

Resource Conservation	190
Sleep methods	190
Wake and condition methods	191
To Set the GC to Conserve Resources	193

13 Programming

Clock Time Programming	196
Using clock time events	196
Adding events to the clock table	196
Deleting clock time events	196

14 Flow and Pressure Modules

About Flow and Pressure Control	198
Maximum Operating Pressure	199
Auxiliary Pressure Controllers	200
Restrictors	201
Example: Using the PCM Channels	203
PIDs	204

15 Inlets

Inlet Overview	206
About the Split/Splitless Inlet	207
Selecting the correct S/SL inlet liner	207
About the Multimode Inlet	209
MMI split mode minimum operating pressures	209
Selecting the correct MMI liner	210
About the Purged Packed Column Inlet	212
About the Cool On-Column Inlet	213
Setup modes of the COC inlet	213
Retention gaps	213
About the PTV Inlet	214
PTV sampling heads	214
About the Volatiles Interface	215
VI operating modes	215
About the VI split mode	216
About the VI splitless mode	218
About the VI direct mode	221
Preparing the Interface for Direct Sample Introduction	224
VI direct mode setpoint dependencies	226
VI direct mode initial values	226
Direct mode parameters	226

16 Columns and Oven

About the Oven Insert	230
Hydrogen Sensor	231
Instrument logs	231
Calibration	231
Status information	231
Operation with an Agilent data system	231

17 Chromatographic Checkout

About Chromatographic Checkout	234
To Prepare for Chromatographic Checkout	235
To Check FID Performance	237
To Check TCD Performance	242
To Check NPD Performance	246

To Check ECD Performance	250
To Check FPD+ Performance (Sample 5188-5953)	254
Preparation	254
Phosphorus performance	254
Sulfur performance	258
To Check FPD+ Performance (Sample 5188-5245, Japan)	260
Preparation	260
Phosphorus performance	260
Sulfur performance	264

18 Chinese Metrology Testing

FPD+ and ECD Unit Conversion Factors	268
Conversion factors for the FPD+	268
Conversion factor for the ECD	268
Using the Conversion Factors	270
References	271

19 Glossary

1

Getting Started

The 8890 Gas Chromatograph	12
Before Operating Your GC	13
Chromatography Using a GC	14
Inlets	15
Automatic injectors	15
Automatic sampling valves	15
GC Columns and Oven	16
Detectors	17
Touchscreen	18
System Operation	20
Browser Interface	23
Status Indicator	27
GC Status	28
Overview of Running a Sample	29
Instrument Control	30
Correcting Problems	31

This document provides an overview of the Agilent 8890 Gas Chromatograph (GC) along with detailed operating instructions.

The 8890 Gas Chromatograph

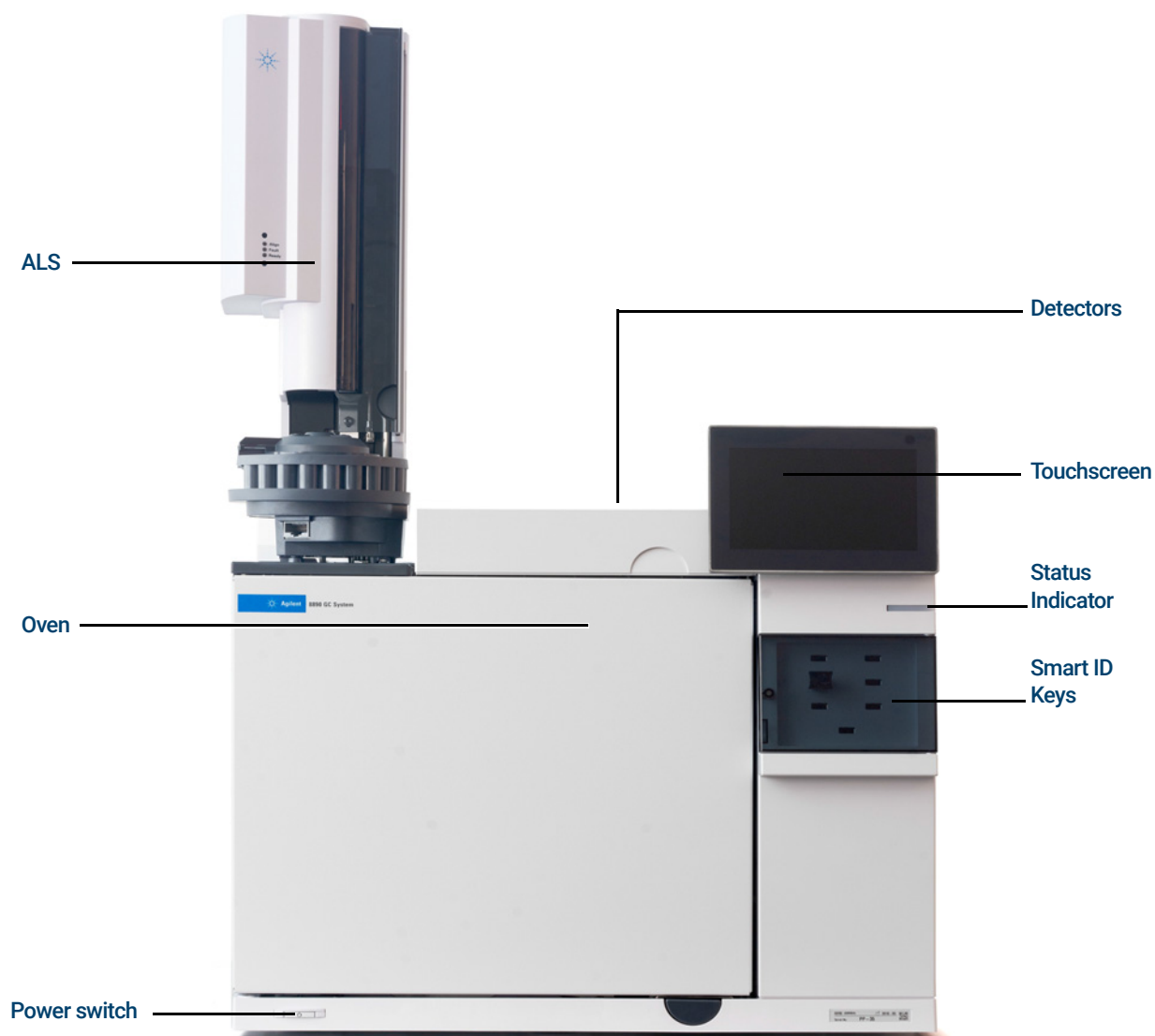

Figure 1. The 8890 GC

Before Operating Your GC

Before operating your GC, be sure to read the safety and regulatory information included on the *Agilent GC and GC/MS User Manuals & Tools* DVD, the Browser Interface or a connected web browser. The most common safety hazards when working on the GC are:

- Burns caused by touching heated areas on or in the GC.
- Release of pressurized gas containing hazardous chemical compounds caused by opening inlets.
- Glass cuts or puncture wounds caused by sharp capillary column ends.
- Use of hydrogen as a GC carrier gas.

Chromatography Using a GC

Chromatography is the separation of a mixture of compounds into individual components.

There are three major steps involved with separating and identifying components of a mixture using a GC. They are:

- 1 **Injecting** a sample into the GC. (This takes place at the inlet.)
- 2 **Separating** the sample into individual components. (This takes place inside the column in the oven.)
- 3 **Detecting** what compounds were in the sample. (This is done in the detector.)

During this process, status messages from the GC are displayed, and user changes to parameter settings can be made through the GC touchscreen, Browser Interface, or data system.

Inlets

Inlets are where samples are injected into the GC. The Agilent 8890 GC can have a maximum of two inlets, identified as Front Inlet and Back Inlet.

The following inlet types are available:

- Split/splitless inlet (SSL)
- Purged packed inlet (PP)
- Multi-Mode Inlet (MMI)
- Cool on column inlet (COC)
- Programmed Temperature Vaporization Inlet (PTV)
- Volatiles Interface (VI)

The type of inlet chosen is based on the type of analysis being done, the type of sample being analyzed, and the column being used.

Samples can be injected into the inlets by hand using a syringe, or an automatic sampling device (such as an Agilent Automatic Liquid Sampler or Agilent Headspace Sampler).

Automatic injectors

The Agilent 8890 GC can accommodate up to two autoinjectors, identified as Front Injector and Back Injector.

Automatic sampling valves

The optional sampling valves are simple mechanical devices that introduce a sample of fixed size into the carrier gas stream. Valves are most frequently used to sample gases in constantly flowing streams.

The Agilent 8890 GC can accommodate up to two gas or liquid sampling valves, identified as Valve #1 and Valve #2.

The valves are located inside the sampling valve box.

GC Columns and Oven

GC columns are located inside a temperature-controlled oven. Generally, one end of the column is attached to the inlet, while the other end is attached to the detector.

Columns vary in length, diameter, and internal coating. Each column is designed for use with different compounds.

The purpose of the column and the oven is to separate the injected sample into individual compounds as it travels through the column. To aid this process, the GC oven can be programmed to speed the sample flow through the column.

The Agilent 8890 GC can accommodate up to six columns, identified as Column #1 through Column #6.

The 8890 will have six Smart ID Key slots on the front of the instrument. These keys hold configuration information about the columns on the system. The Column Smart ID Keys will define column information that could be transferred between GCs. After inserting a Smart ID Key, you will be prompted to input which number column (1-6) the key corresponds to. After setting the column number, set the inlet and outlet connections. The GC will then lock this column's configuration as long as the Smart ID Key remains installed.

After removing a Smart ID Key, the GC will provide a confirmation message to confirm that the key was removed intentionally. If confirmed, the corresponding column can be either deconfigured, or left configured and unlocked.



Detectors

Detectors identify the presence of compounds as they exit the column.

As each compound enters the detector, an electrical signal proportional to the amount of compound detected is generated. This signal is generally sent to a data analysis system—such as Agilent OpenLAB CDS ChemStation edition—where it shows up as a peak on a chromatogram.

The GC can accommodate up to four detectors (three mounted on top of the GC, and one mounted in a side carrier), identified as Front Detector, Back Detector, Aux 1 Detector, and Aux 2 Detector.

A complete selection of detectors (FID, TCD, NPD, NCD, FPD+, ECD, SCD, and MSD) are available. The type of detector chosen is based on the type of analysis required.

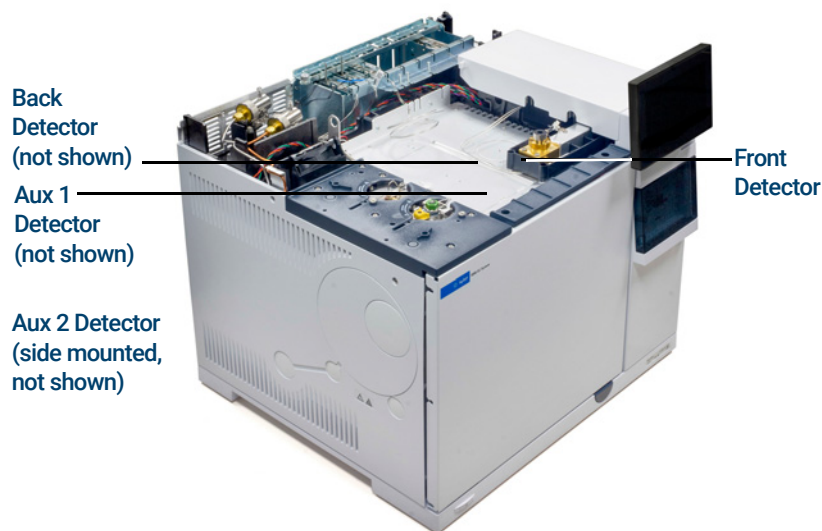

Figure 2. Detector locations

NOTE

An Aux 1 Detector may only be a TCD or FPD+. Other detector types are not supported in this position.

An Aux 2 Detector may only be a TCD, ECD, or FID. Other detector types are not supported in this location.

Touchscreen

The touchscreen shows GC status and activity information, and allows you to start, stop, and prepare the GC to run a sample. The touchscreen also provides access to GC setpoints, real-time signals, diagnostics, maintenance information, logs, and instrument configuration settings. More information about the touchscreen can be found in the Touchscreen Help. For more information on accessing the Touchscreen Help, see **“Help from the Touchscreen”**.

To save energy and increase display life, the touchscreen darkens after an operator specified period of inactivity. Touching the screen brightens it again.

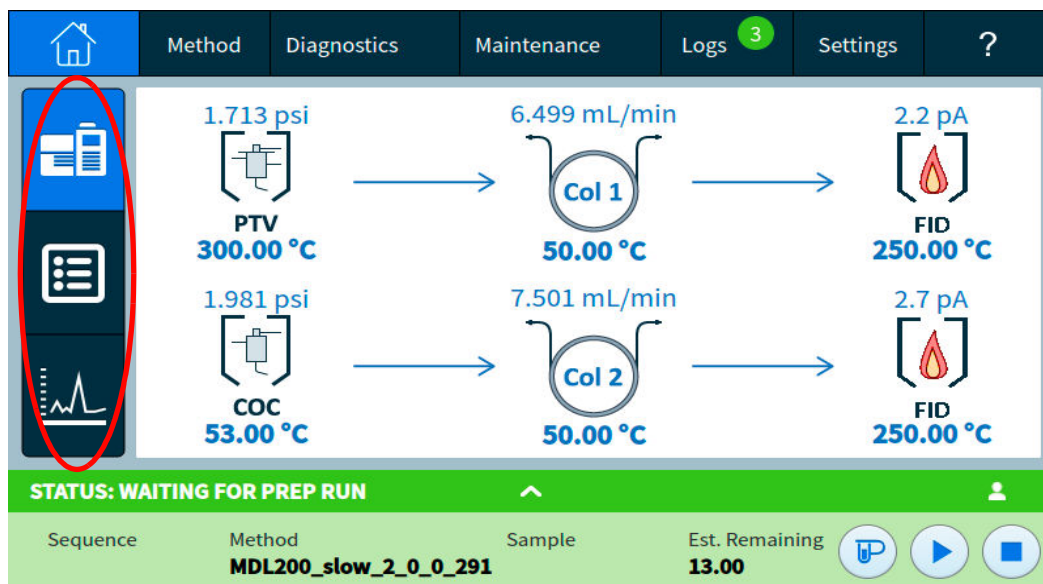

Figure 3. View status, status listing, and live plots.

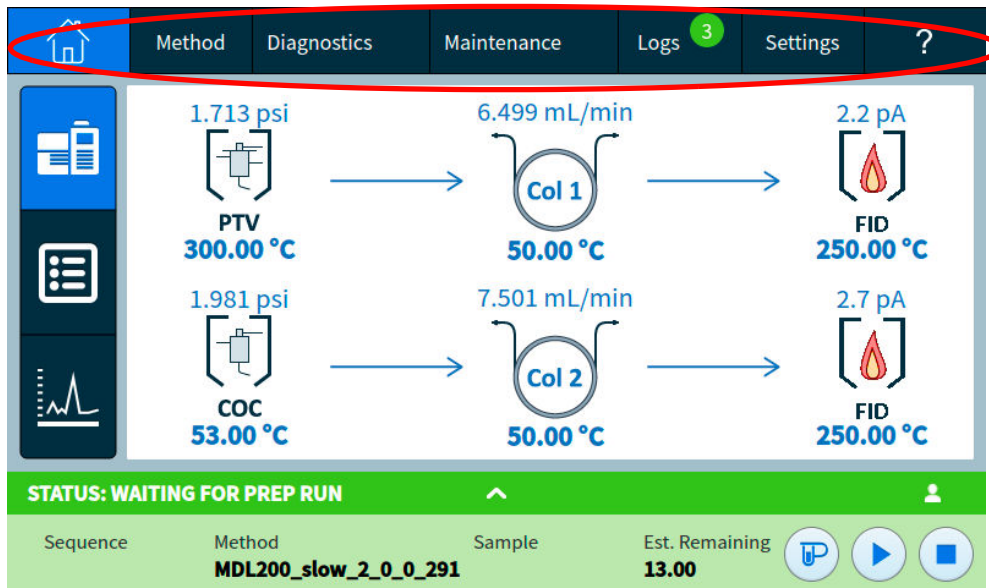

Figure 4. Navigate between home, setpoints, automated maintenance, and help.

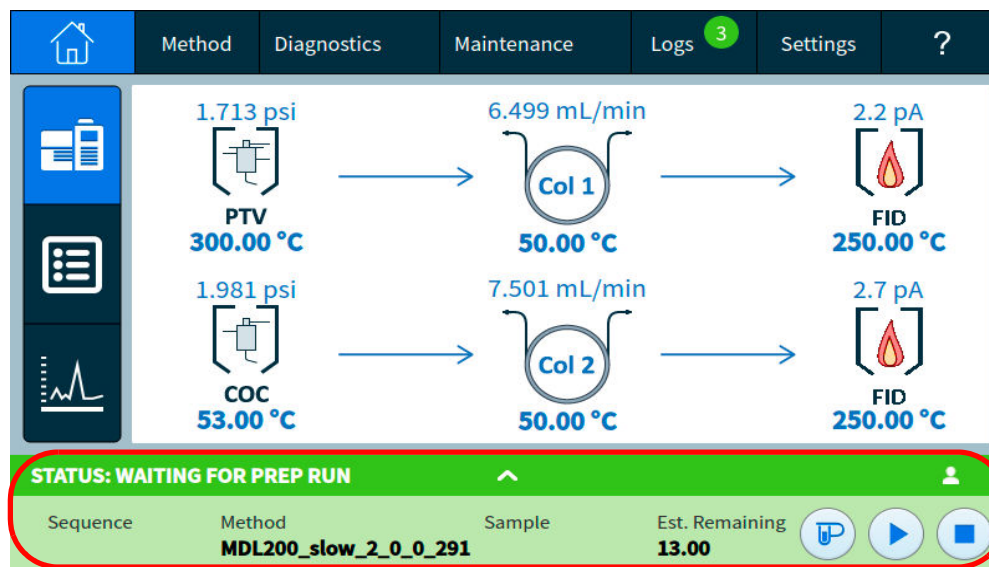

Figure 5. Closable run control and status tray.

See **“Touchscreen Operation”** for a detailed description of the touchscreen functions and capabilities.

System Operation

The GC can be controlled using the touchscreen, the Browser Interface, and an Agilent data system.

Touchscreen

The touchscreen provides direct control of configuration settings, access to diagnostic and maintenance functions, logs, and access to help, as well as the ability to make temporary changes in setpoints. Use the touch display to:

The touchscreen provides controls for:

- Setting the GC IP address
- Selecting the touchscreen language
- Viewing status data and real-time plots.
- Monitor GC and run status
- Editing the current method setpoints (current oven temperature, flows, and so forth)
- Monitor system health
- Perform maintenance tasks
- Perform diagnostic tasks and tests and resolve diagnostic conditions
- Track consumables usage and usable life remaining
- Make system settings, for example system locale, IP address setup, and so forth
- View system logs
- Set GC clock table and resource conservation events

The tray at the bottom of the touchscreen provides run control:



Prep Run: Typically required before manual injections to exit any gas saver mode and to prepare the inlet flows for injection.



Start



Stop: Stops the current run.

Some tasks, such as setting the IP address, can only be performed using the touchscreen.

Browser Interface

The Browser Interface provides many of the same functions as the touchscreen. The Browser Interface provides for instrument setup and control, as well as the ability to run the instrument stand-alone (without a connected data system). The Browser Interface can be viewed using any typical web browsing device, such as a computer or tablet, provided the device is connected to the same gateway as the GC. Use the Browser Interface to:

- Create methods
- Run samples and sequences of samples
- Run diagnostic tests
- Check status and performance of the GC
- Perform maintenance procedures
- Check maintenance details and reset counters
- Change language settings
- Access on-line help

To connect to the Browser Interface:

- 1 On a tablet or computer connected to the same gateway as the GC, open a browser window.
- 2 Navigate to **http://GC Name or IP Address**. For example, if the GC IP address is 10.1.1.100, navigate to **http://10.1.1.100**.
- 3 If prompted, enter the access code. (The access code is available at the GC touchscreen.)

For more information regarding the Browser Interface, see **"Browser Interface"**.

When a data system is controlling the GC, setpoint changes and other features may be disabled in the Browser Interface. If multiple users connect to a GC using the Browser Interface, only the first connection has normal control.

Data System

The data system adapter provided with Agilent data systems, such as OpenLAB CDS, provides full control of the GC for creating methods, running samples, and so forth. Use the data system to:

- Create methods
- Run samples and sequences of samples
- Monitor GC and run status
- Monitor system health
- Track consumables usage and usable life remaining
- Make some system settings
- View system logs
- Set GC clock table and resource conservation events

In addition, the data system adapter provides access to the complete help and user information. From anywhere within the method editor for the GC, select **Help and Information Browser Interface** from the navigation tree.

Also note:

- The data system adapter does not provide direct access to all of the GC's diagnostic and maintenance features.
- The data system cannot directly use any methods or sequences created in the Browser Interface.
- When connected to the GC, the data system adapter can be set to restrict anyone from making certain changes at the touchscreen or with a Browser Interface.

Browser Interface

You can control and monitor the GC using a web browser that is on the same gateway as the GC. An internet connection is not required. This Browser Interface can be accessed by using computer browser clients and mobile device client browsers, such as tablets. The Browser Interface provides complete control of the GC. Use it to perform tasks such as:

- Configuring GC gas types and flows
- Performing automated maintenance procedures
- Running diagnostic tests
- Creating, editing, and loading methods
- Running samples
- Creating, editing, and loading sequences of samples
- Monitoring GC performance (viewing logs, current statuses, and plots)

While connected to your GC with a data system, you can not edit methods, edit sequences, and start or stop runs using the Browser Interface. See **“What is a Method?”** for more details.

The screenshot shows the GC Browser Interface. At the top, there is a navigation bar with tabs: Method, Sequences, Diagnostics, Maintenance, Logs, Settings, and Help. Below this is a toolbar with icons for navigation and file operations. On the left, there is a tree view showing the system hierarchy: ALS/Tray, Front Injector, Other, Valves, Inlets (Front Inlet - 55, Back Inlet - MM1), Columns, Oven, Detectors (Front Detector - FID, Back Detector - TCD, Aux Detector 2 - TCD), and Analog Out (Analog Out 1, Analog Out 2). The main area displays a table of components:

Name	Type	On	Load Time (min)	Inject Time (min)
1	Not Installed			
2	Not Installed			
3	Not Installed			
4	Not Installed			
5	Not Installed			
6	Not Installed			
7	Not Installed			
8	Not Installed			
9	Not Installed			
10	Not Installed			

At the bottom, there is a status bar showing 'STATUS: READY' and a table with columns: Sequence, Method, Sample Name, and Est. Remaining. The current values are: Sequence, AdoledCo12, Sample Name, and 1.

Annotations on the right side of the image:

- A red box highlights the top navigation bar and toolbar, with the text: **Edit GC Methods, Sequences, Settings, and more**
- A red box highlights the right-hand sidebar, with the text: **Access your Help & Information Suite**
- A red box highlights the bottom part of the sidebar, with the text: **View context sensitive help about your current screen**

When using the Browser Interface, the GC stores run data internally. Access can be granted to allow a connected computer on the same gateway to access this data and copy it for analysis. Note that run data can only be deleted by using the Browser Interface directly, or by the GC according to either date or disk space settings.

To connect to the GC using a browser:

1 Getting Started

- 1 If you do not know the GC's IP address or host name, use the touchscreen to find it.

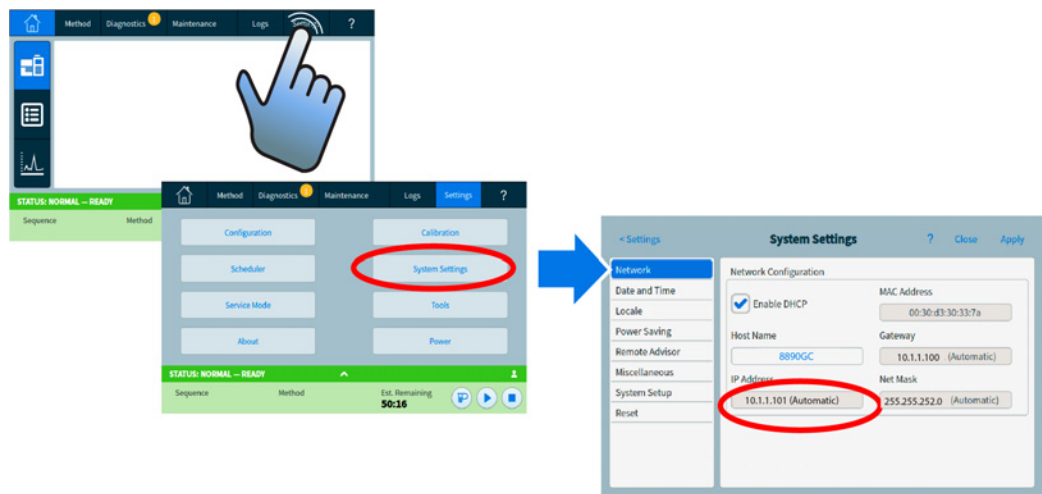

- 2 Open a web browser. Supported browsers include Chrome, Safari (on a tablet), Internet Explorer 11, and Edge. Make sure the browser version is up to date.
- 3 Enter `http://xxx.xx.xx.xxx`, where `xxx.xx.xx.xxx` is the GC's IP address. (If using a host name, enter it instead.) In this example, the GC IP address is 10.1.1.101. Accessing the Browser Interface only requires that the tablet or computer be connected to the same gateway as the GC; no internet connection is required.

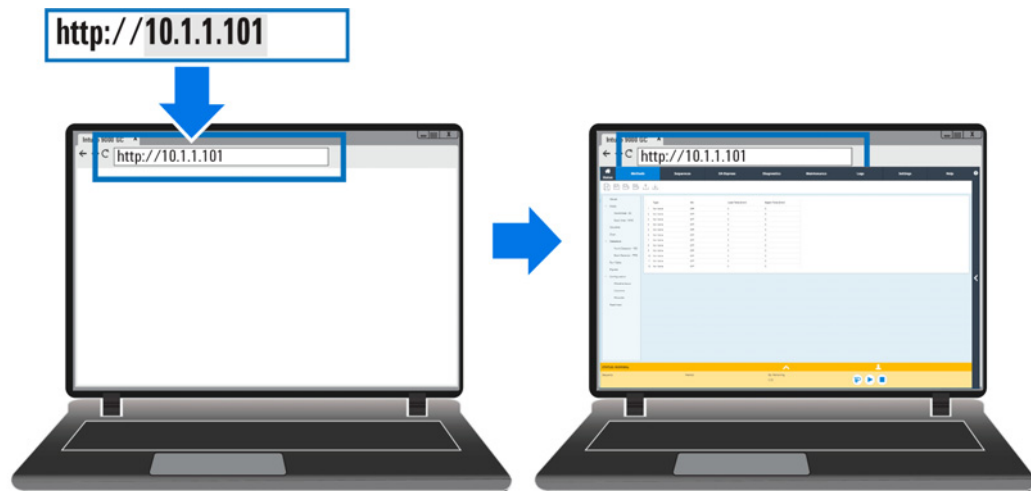

For more information on how to utilize the Browser Interface, click the Help tab to access the Help & Information suite, or click the < on the right side of the screen to access the context sensitive help. See **“Help from a Browser”** and **“Context-Sensitive Help”** for more information.

1 Getting Started

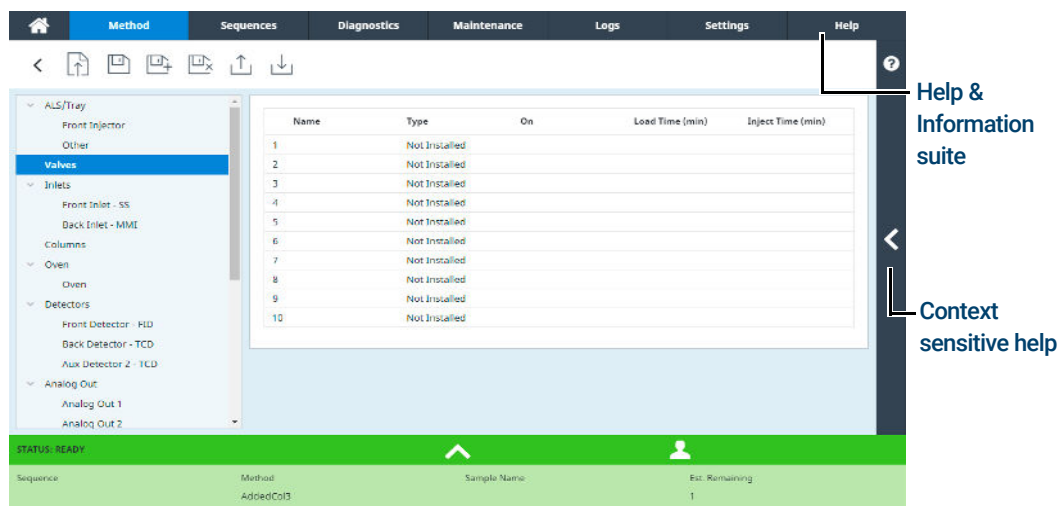

Figure 6. Accessing help from the Browser Interface

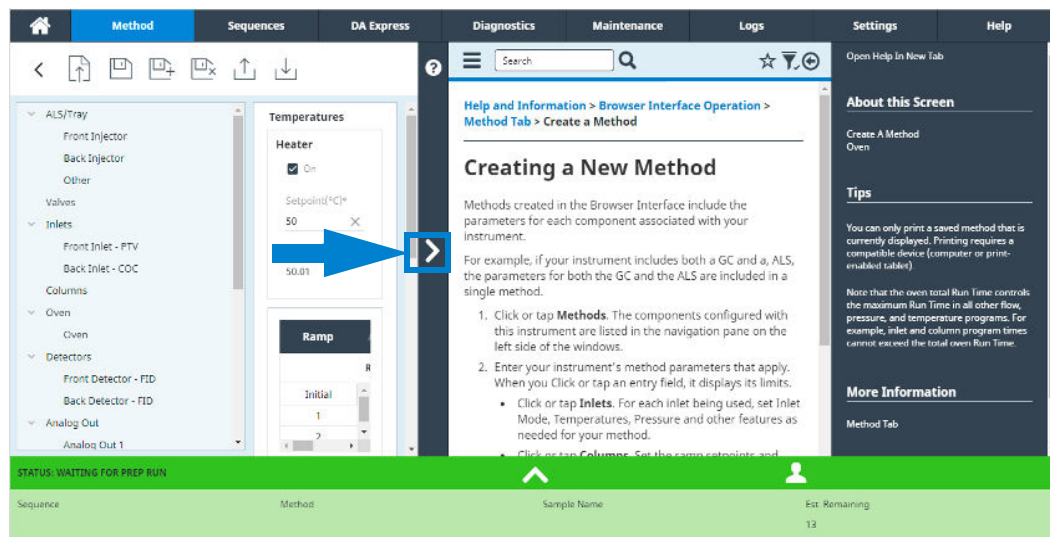

Figure 7. Context sensitive help

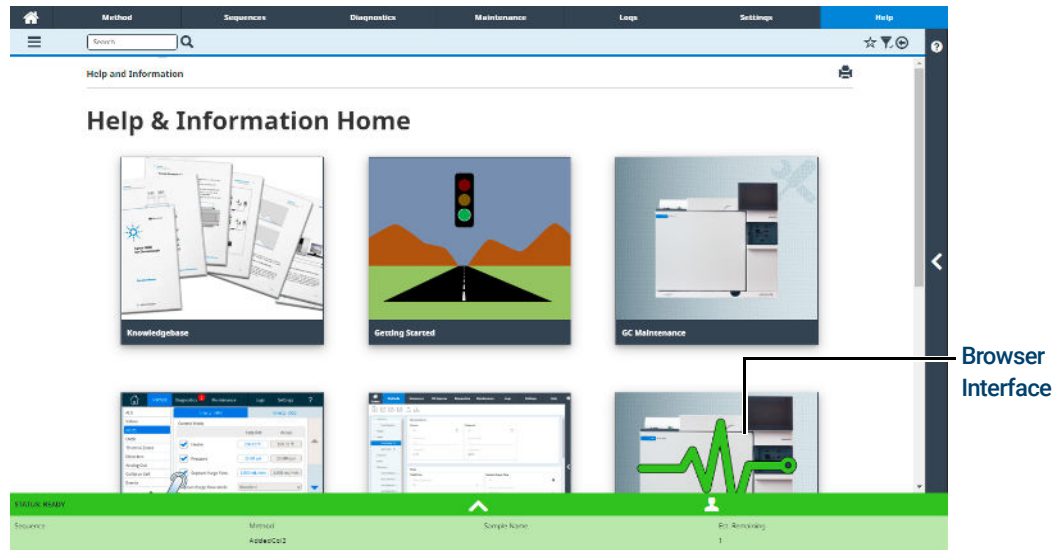

Figure 8. Complete Help and Information content

This manual focuses on GC operation using the touchscreen. While many functions are similar between the touchscreen and Browser Interface, refer to the help provided in the Browser Interface when using it to control the GC.

Status Indicator

The GC includes a status indicator on the front panel to allow you to quickly determine the status and readiness of the GC. The status indicator changes color depending on the current state of the GC.

- Green: Indicates that GC is ready for operation.
- Yellow: Indicates that the GC is not ready for operation. Power is on and available, but not all parameters have reached operating setpoints. A warning or other message may exist. Check the GC touchscreen for additional information.
- Red: Indicates a fault or other serious condition. A fault or other message may exist. Check the GC touchscreen for additional information. The GC cannot be used until the fault condition is resolved.



GC Status

When the GC is ready to begin a run, the touchscreen shows **STATUS: READY FOR INJECTION**. Alternately, when a component of the GC is not ready to begin a run, the touchscreen shows **STATUS: NOT READY** and the status indicator on the GC front panel is yellow. Tapping the **Diagnostics** tab displays indications of why the GC is not ready.

Alert tones

The GC provides information via beeps.

A series of warning beeps sounds before a shutdown occurs. The GC starts with one beep. The longer the problem persists, the more the GC beeps. After a short time the component with the problem shuts down, the GC emits one beep, and a brief message is displayed. For example, a series of beeps sounds if the inlet gas flow cannot reach setpoint. The message **Inlet flow shutdown** is briefly displayed. The flow shuts down after 2 minutes.

WARNING

Before resuming GC operations, investigate and resolve the cause of the hydrogen shutdown.

One beep sounds when a problem exists, but the problem will not prevent the GC from executing the run. The GC will emit one beep and display a message. The GC can start the run and the warning will disappear when a run starts.

Fault messages indicate hardware problems that require user intervention. Depending on the type of error, the GC emits no beep or a single beep.

Error conditions

If a problem occurs, the GC status bar changes to Not Ready, the GC status indicator turns yellow, a number appears next to the Diagnostics tab, and the status tray and Diagnostics tab list the condition that is causing the Not Ready condition. Select **Diagnostics** to view the issue and resolve it.

When configured for enhanced GC-MS or GC-HS communications, error messages from the connected instruments will also be displayed.

Clearing a shutdown condition

When a component is shut down, the GC becomes Not Ready, the status indicator and status bar turn yellow, and the Diagnostics tab and status tray display messages about the condition that caused the shutdown.

To clear a shutdown, select **Diagnostics > Clear shutdown - ON** to turn on all zones, including the one that was shut down, or select **Clear shutdown - OFF** to turn on all zones except the one that was shut down. Note that if you clear the shutdown but do not resolve the problem that caused it (for example, changing a gas supply cylinder or fixing a leak), the GC will shut down again.

Overview of Running a Sample

Operating the GC involves the following tasks:

- Setting up the GC hardware for an analytical method.
- Starting up the GC. See **“To Start Up the GC”**.
- Preparing any attached sampler. Install the method-defined syringe; configure solvent and waste bottle usage and syringe size; and prepare and load solvent, waste, and sample vials, as applicable. Refer to the documentation provided with your ALS or Headspace Sampler (HS) for details on its installation, operation, and maintenance.
- Setting up the active method, or editing sequences.
 - See the Agilent data system documentation.
 - For standalone GC operation see **“Editing the Active Method”**.
- Running the method or sequence.
 - See the Agilent data system documentation.
 - For standalone GC operation, see **“To manually inject a sample with a syringe and start a run”** and **“To run a method to process a single ALS sample”**.
- Monitoring sample runs from the GC touchscreen, Browser Interface, or Agilent data system. See **“Home View”**, or the Agilent data system documentation.
- Shutting down the GC. See **“To Shut Down the GC for Less Than a Week”** or **“To Shut Down the GC for More Than a Week”**.

Instrument Control

The Agilent 8890 GC is typically controlled by an attached data system such as Agilent OpenLAB CDS. Please refer to the online help included in the Agilent data system for details on how to load, run, or create methods and sequences using the data system.

Correcting Problems

If the GC stops operation because of a fault, check the touchscreen or Browser Interface for any messages. The GC includes diagnostics functions to help you determine the cause of a fault.

- 1 Use the touchscreen, Browser Interface, or data system to view the alert. (See **“Home View”** and **“Diagnostics”** for details.)
- 2 Tap the stop button  on the touchscreen, click the stop button on the Browser Interface, or turn off the offending component in the data system.
- 3 Diagnose the problem using the built in diagnostics tools on the GC. See **“Diagnostics”**.
- 4 Resolve the problem by, for example, changing gas cylinders or fixing the leak.

Once the problem is fixed, you may need to power cycle the instrument. Most shutdown errors can be cleared from the LUI, but some may require a power cycle.

2

Help and Information

Where to Find Information 34

Help from the Touchscreen 35

 Touchscreen Help 36

Help from a Browser 39

Context-Sensitive Help 43

Agilent GC and GC/MS User Manuals & Tools DVD 45

Where to Find Information

Agilent provides an extensive amount of documentation for installing, operating, and maintaining the instrument directly from the 8890 GC. In addition, there are multiple ways to access the comprehensive Help and Information suite either from the touchscreen, through a browser, or from your Agilent data system.

- “Help from the Touchscreen”.**
 Includes a comprehensive suite of documentation including context-sensitive information and tips right from the 8890 GC touchscreen.
- “Help from a Browser”.**
 The complete set of user information is available directly from the GC by using a connected web browser.
- “Context-Sensitive Help”.**
 In addition to the complete set of user documentation, context-sensitive information is also available from the Browser Interface.
- “Agilent GC and GC/MS User Manuals & Tools DVD”.**
 Information about the 8890 GC, mass specs, and samplers is also available on the Agilent GC and GC/MS User Manuals & Tools DVD.

When unpacking the instrument, make sure you take a look at the provided 8890 GC *Quick Start Poster* to help you quickly get familiar with your GC, as well as setup and configure your instrument. This poster can also be found in your browser help, in the familiarization section.

Help from the Touchscreen

Available right at your fingertips from the 8890 GC is an extensive amount of on-board documentation designed to assist with topics such as getting started, familiarization, installation, operation, maintenance, troubleshooting, and other useful information.

There are several ways to access this information, including through the touchscreen help '?' menu. Here you will find not only context-sensitive information, but also a listing of tips to quickly guide you to information needed, and a full **Help and Information** suite with topics about maintenance, diagnostics, part views, operations, settings, and familiarization. See **“Touchscreen Help”** for additional information and features available with the touchscreen help package.

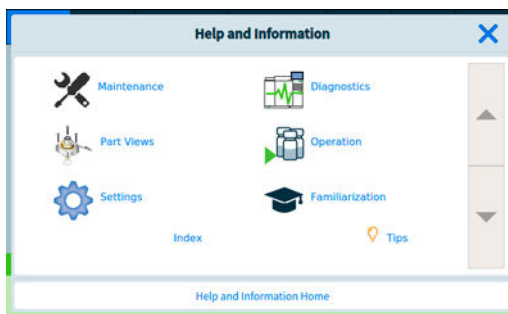
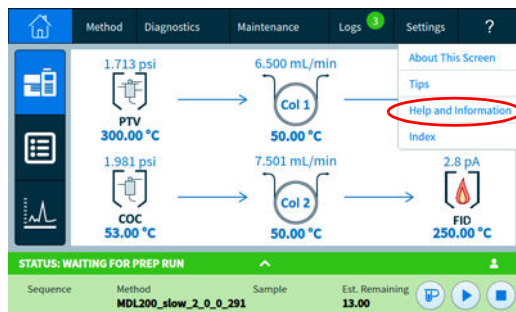

Touchscreen Help

When using the GC, a help menu is available by selecting the question mark (?) in the upper right corner of the touchscreen. The help menu provides access to context-sensitive information about the screen you are viewing, tips, access to the full Help & Information suite, as well as an Index to assist in finding needed information.

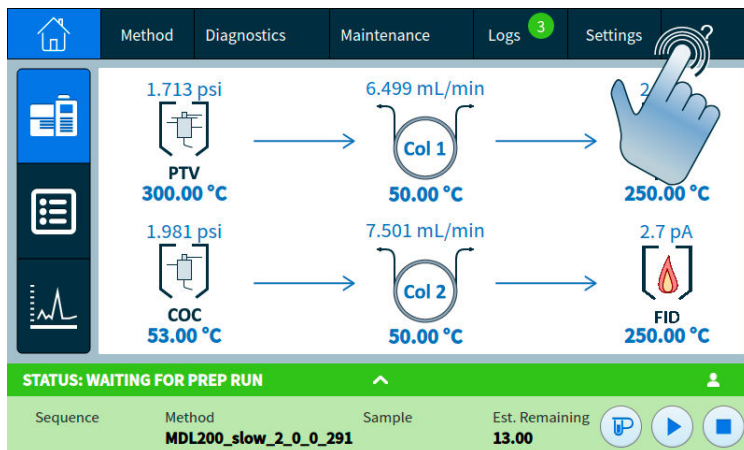

- 1 **About This Screen** provides context-sensitive details about the screen currently being viewed.

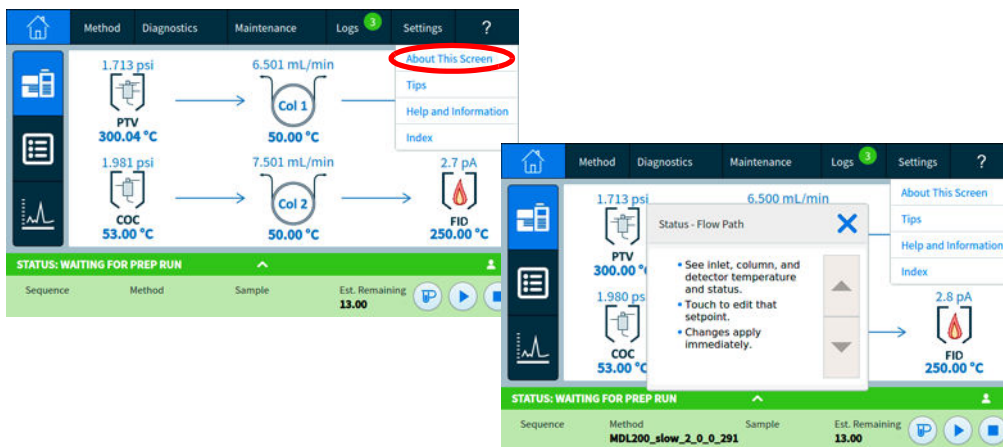

2 Help and Information

- Tips** provides helpful information on how to use the GC. Individual tips are provided which contain answers to frequently asked questions, as well as links to frequently used procedures.

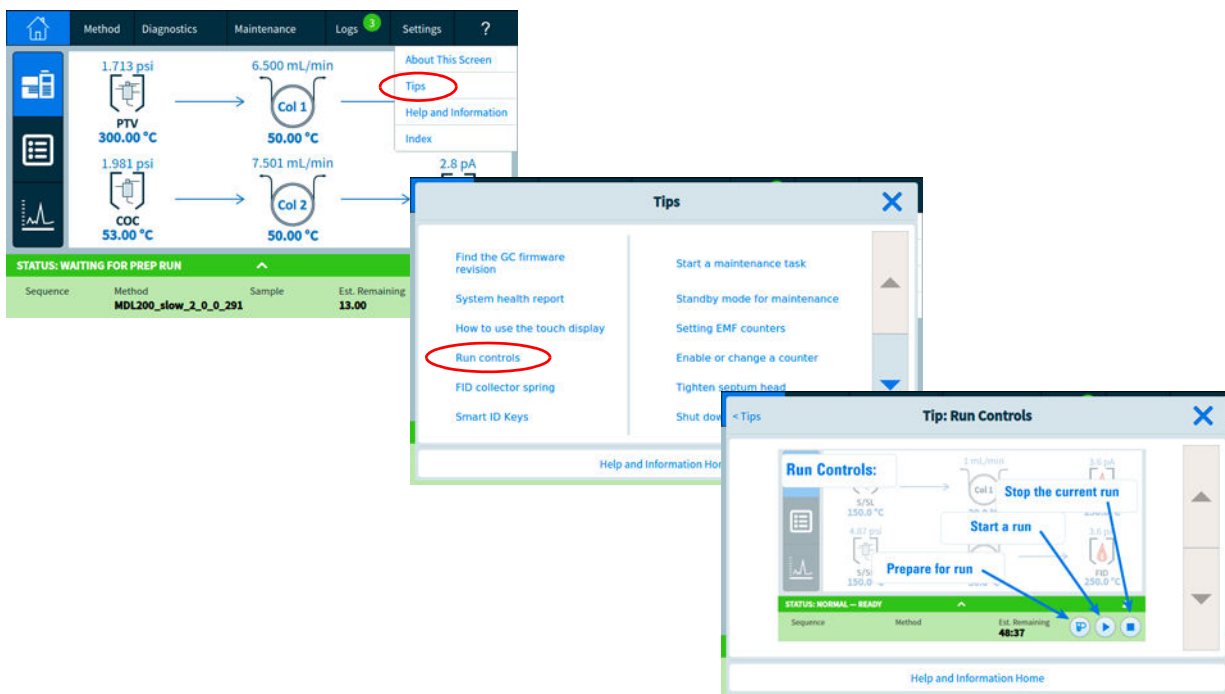

- Help & Information** provides comprehensive, in-depth information related to maintenance, diagnostics, part views, operation, settings, and more.

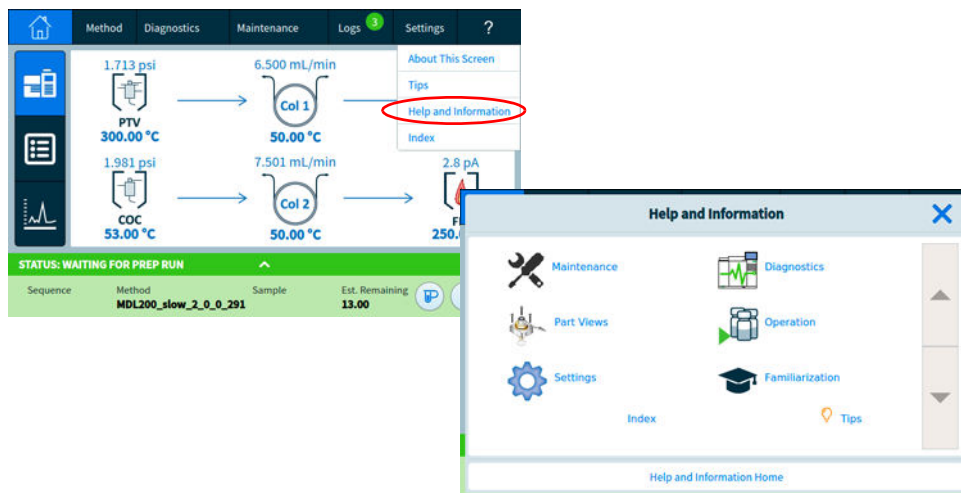

- Maintenance:** How to take care of the inlets, detectors, and modules available on this configured GC.
- Part Views:** The consumable parts for inlets, detectors, and modules configured on this GC.
- Settings:** Configuration and calibration for each available module on this GC. Also includes explanation for the Instrument Scheduler.

2 Help and Information

- **Diagnostics:** Automated and manual tests available on this GC.
- **Operation:** How to use the inlets, detectors, and modules available on this configured GC.
- **Familiarization:** Where to find information regarding the GC, using the touch display, how to use the system setup wizard, accessing the feature tour, and an overview of the GC parts.

4 The **Index** provides an alphabetized list of the topics contained in the touchscreen help.

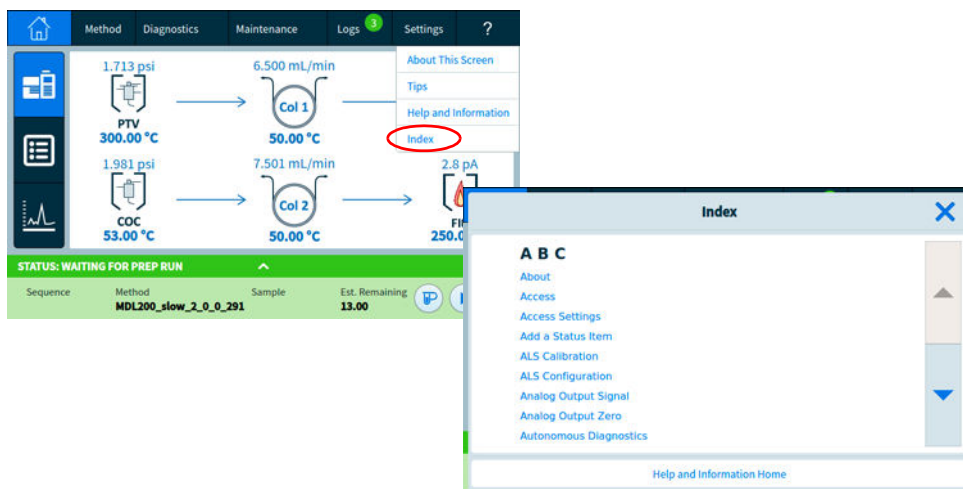

Help from a Browser

You can access an extensive amount of on-board documentation that is designed to assist with topics such as getting started, familiarization, installation, operation, maintenance, troubleshooting, and other useful information. **Access to the internet is not required to use this enhanced help package.** Accessing this help only requires that your PC or tablet be connected to the same gateway as your GC.

This enhanced version of **Help & Information** can be easily accessed through:

- The Browser Interface. Access the Help & Information suite by clicking the **Help** tab in the Browser Interface. See **“Browser Interface”** for instructions on connecting to the Browser Interface.

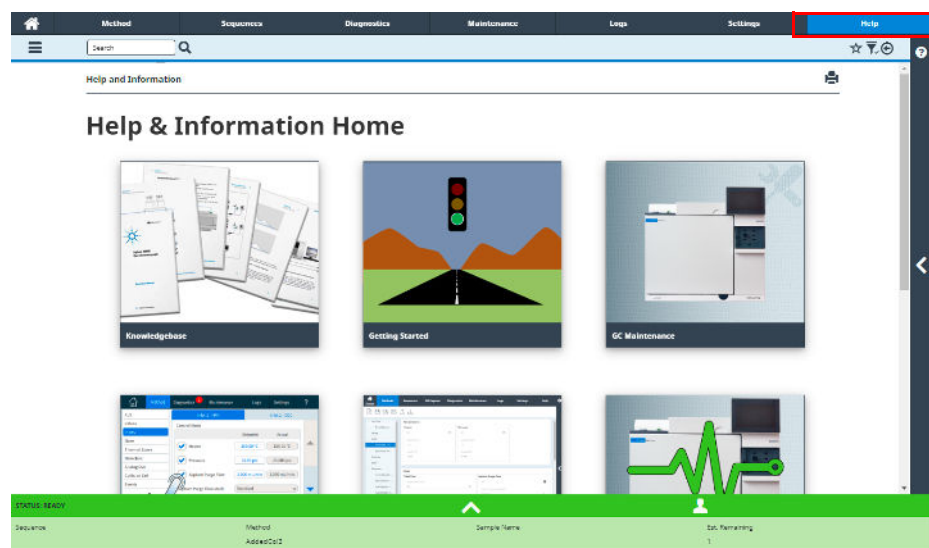

- Your Agilent data system. Access the Help & Information suite by clicking the **Help & Information Browser Interface** link at the top of the tree view.

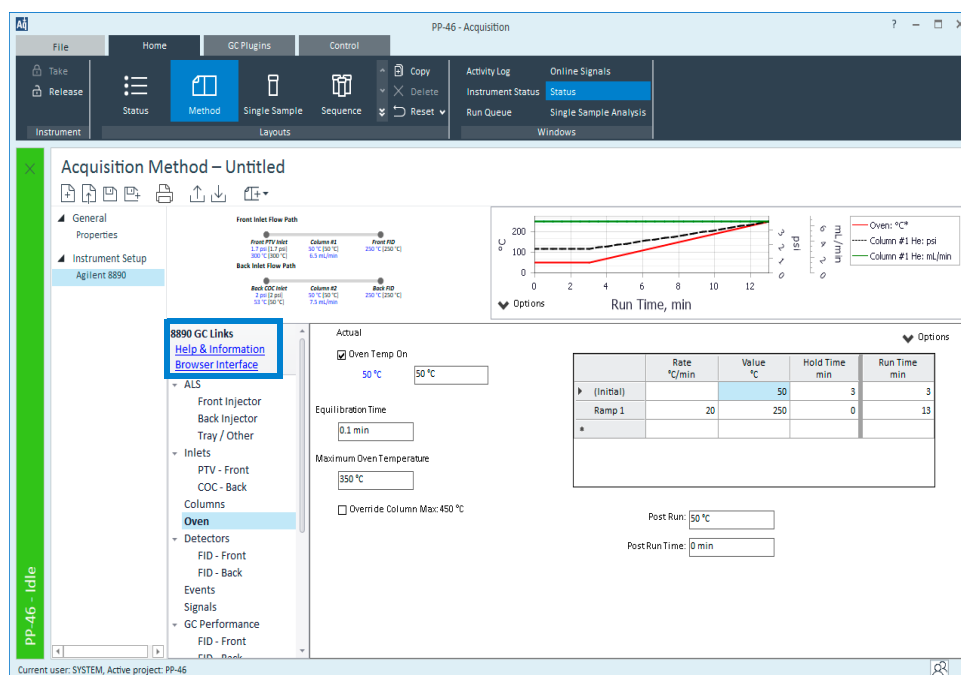



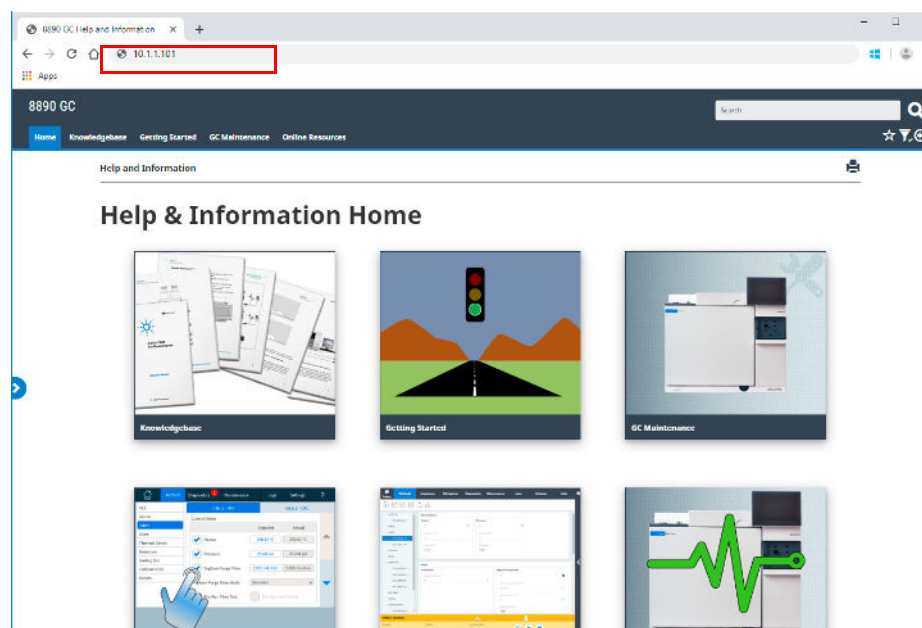

- A web browser on any device that is on the same gateway as the GC. Access the Help & Information suite by typing `http://xxx.xx.xx/inf` into your web browser of choice, where `xxx.xx.xx` is the IP address or host name of your GC.



Accessing the Help & Information suite provides you with the following information:

- **Knowledgebase:** manuals, installation info, safety info, and site prep.
- **Getting Started:** BrowserUI tutorial, Quick Start Poster, eFam, a GC Feature Tour, the System Setup Wizard, and instructional videos.
- **Maintenance:** information for performing maintenance on your configuration (inlets, detectors, etc.).
- **System Operation:** information on operating your GC, such as its settings, or EMF counters.
- **Diagnostics:** information on the diagnostic tests, self-guided diagnostics, and tasks available on your GC.
- **Browser Interface Help:** help and instructions for using the Browser Interface.
- **Online Resources:** links to Agilent University, Agilent YouTube, Agilent Community, services, and more.

By default, the help is filtered to only show information pertaining to your GC's configuration. If information does not appear to be available, be sure to enable all help content. To check your active filters, click the  icon in the top right corner of the Help & Information screen. These filters allow you to show or hide information pertaining to the various components of your GC, such as information about specific detectors or inlets.

In addition, you can set frequently visited topics as favorites for easy access. To do so, navigate to the desired topic, and click the  icon. Once a topic has been added to your favorites, the icon  becomes filled in. Click this icon again to remove the topic from your favorites. Your favorites can be viewed at any time by clicking the  icon. From here, click any of the listed topics to quickly access them, or click the  to remove the topic from your favorites.

The history icon  lists the recent help topics visited in the current browser session. From here, select any of the listed topics to revisit them. Select **Clear History** to remove all topics from your history.

2 Help and Information

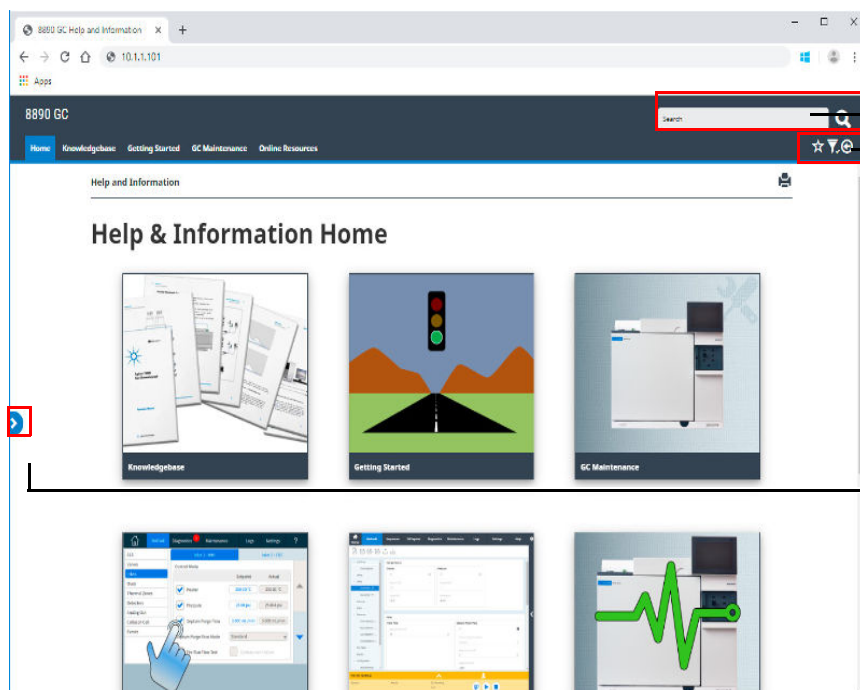

Search all available info
Add and remove favorites, Filter content, and view your history

Show/hide the table of contents

Context-Sensitive Help

Available from each of the Browser Interface pages is the ability to access context-sensitive information or help. Select the < from the right side of the screen to access information and tips relevant to the page you are viewing. About this Screen provides several links to relevant help topics. When clicked, these links open their corresponding topics within the help tray. Under Tips, you will see snippets of useful information about the current page. Additionally, some pages will provide links to additional documentation, such as the link to the Method Wizard in the example below.

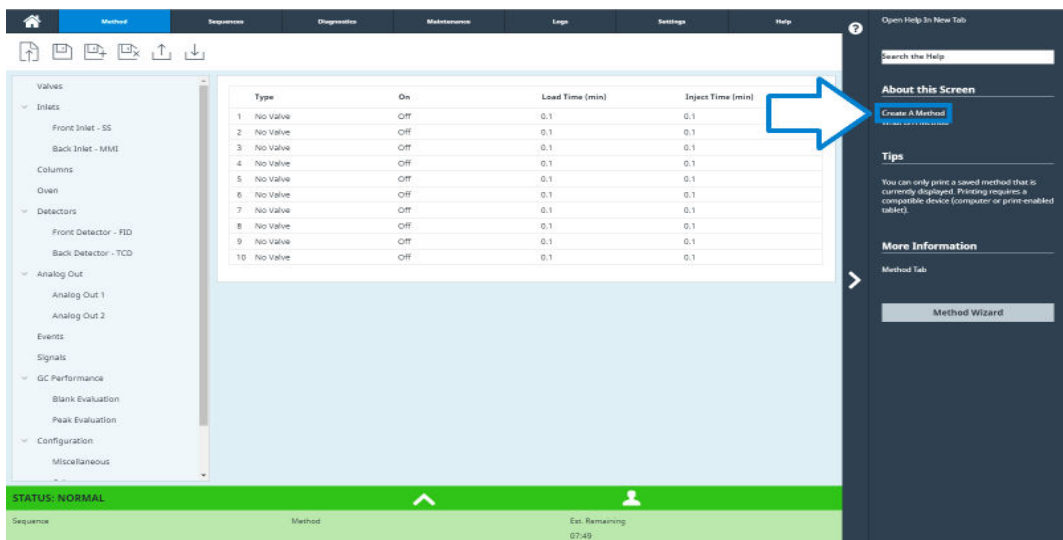
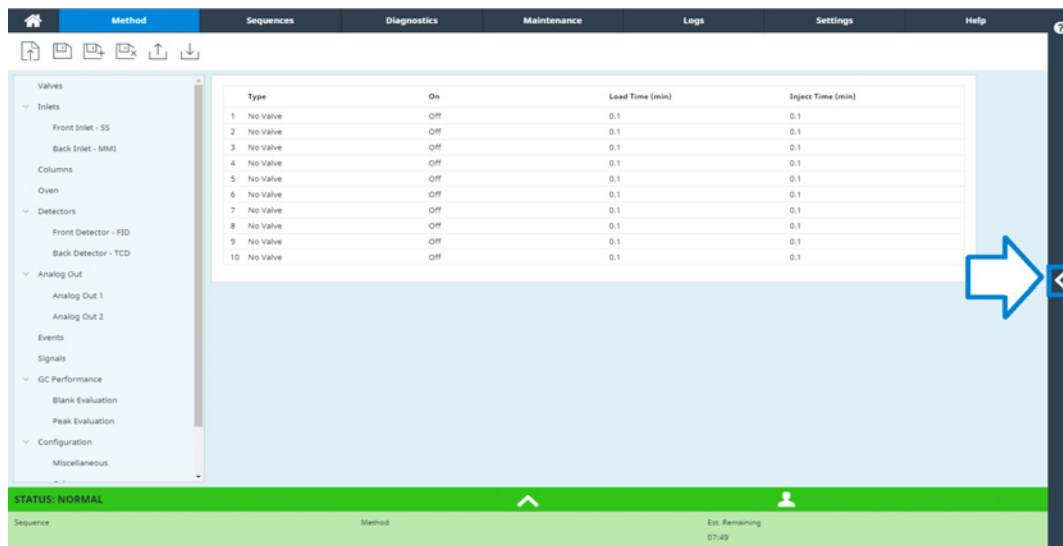

To minimize the topic you are viewing, click the > between the context sensitive help and the page you are viewing. Click the > again to minimize the context sensitive help tray.

2 Help and Information

The screenshot displays the DA Express software interface. At the top, there is a navigation bar with tabs for Method, Sequences, DA Express, Diagnostics, Maintenance, Logs, Settings, and Help. The 'Method' tab is active. On the left, a navigation pane lists various instrument components such as ALS/Tray, Inlets, Oven, and Detectors. The main area shows the 'Temperatures' configuration panel with a 'Heater' section (checked 'On') and a 'Ramp' section. A blue arrow points from the 'Actual' temperature field (50.01) to a help icon (a question mark in a circle) located in the top right corner of the configuration panel. This icon is also highlighted with a blue box. To the right of the configuration panel, a help article titled 'Creating a New Method' is displayed. The article includes a breadcrumb trail: 'Help and Information > Browser Interface Operation > Method Tab > Create a Method'. The article text explains that methods created in the Browser Interface include parameters for each component and provides a list of steps for creating a new method. The bottom of the screen shows a green status bar with the text 'STATUS: WAITING FOR PREP RUN' and a table with columns for Sequence, Method, Sample Name, and Est. Remaining, with the value '13' under 'Est. Remaining'.

Method

Sequences

DA Express

Diagnostics

Maintenance

Logs

Settings

Help

Open Help in New Tab

Help and Information > Browser Interface Operation > Method Tab > Create a Method

About this Screen

Create A Method
Oven

Tips

You can only print a saved method that is currently displayed. Printing requires a compatible device (computer or print-enabled tablet).

Note that the oven total Run Time controls the maximum Run Time in all other flow, pressure, and temperature programs. For example, inlet and column program times cannot exceed the total oven Run Time.

More Information

Method Tab

Creating a New Method

Methods created in the Browser Interface include the parameters for each component associated with your instrument.

For example, if your instrument includes both a GC and a ALS, the parameters for both the GC and the ALS are included in a single method.

1. Click or tap **Methods**. The components configured with this instrument are listed in the navigation pane on the left side of the windows.
2. Enter your instrument's method parameters that apply. When you Click or tap an entry field, it displays its limits.
 - Click or tap **Inlets**. For each inlet being used, set Inlet Mode, Temperatures, Pressure and other features as needed for your method.
 - Click or tap **Columns**. Set the ramp setpoints and

STATUS: WAITING FOR PREP RUN

Sequence	Method	Sample Name	Est. Remaining
			13

Agilent GC and GC/MS User Manuals & Tools DVD

The *Agilent GC and GC/MS User Manuals & Tools* DVD provides an extensive collection of online help and books for current Agilent gas chromatographs, mass selective detectors, and GC samplers. Included are localized versions of the information you need most, such as:

- Getting Familiar documentation
- Safety and Regulatory guide
- Site Preparation information
- Installation information
- Operation guides
- Maintenance information
- Troubleshooting details

3

Startup and Shutdown

To Start Up the GC 48

To Shut Down the GC for Less Than a Week 49

To Shut Down the GC for More Than a Week 50

To Start Up the GC

Successful operation begins with a properly installed and maintained GC. The utility requirements for gases, power supply, venting of hazardous chemicals, and required operational clearances around the GC are detailed in the *Agilent 8890 Gas Chromatograph Site Preparation Guide*.

- 1 Check gas source pressures. For required pressures, see the *Agilent 8890 Gas Chromatograph Site Preparation Guide*.
- 2 Turn on the carrier and detector gases at their sources and open the local shutoff valves.
- 3 Turn on the cryo coolant at its source, if used.
- 4 Turn on the GC power. Wait for **Power on successful** to display on the touchscreen.
- 5 Install the column.
- 6 Check that the column fittings are leak free.
- 7 Set a method for the GC to use.
If using a data system, download the method to the GC.
If using the touchscreen, see **"Editing the Active Method"**
- 8 Wait for the detector(s) to stabilize before acquiring data. The time required for the detector to reach a stable condition depends on whether the detector was turned off or its temperature was reduced while the detector remained powered.

Table 1 Detector stabilization times

Detector type	Stabilization time starting from a reduced temperature (hours)	Stabilization time starting from detector off (hours)
FID	2	4
TCD	2	4
ECD	4	18 to 24
FPD+	2	12
NPD	4	18 to 24

To Shut Down the GC for Less Than a Week

- 1 Wait for the current run to finish.
- 2 If the active method has been modified, save the changes.

WARNING

Never leave flammable gas flows on if the GC will be unmonitored. If a leak develops, the gas could create a fire or explosion hazard.

- 3 Reduce oven temperature to 50 °C or lower. Reduce detector and inlet temperatures to between 150 and 200 °C. If desired, the detector can be turned off. See [Table 1](#) to determine if it is advantageous to shut down the detector for a short time period. The time required to return the detector to a stable condition is a factor.

To Shut Down the GC for More Than a Week

- 1 Put the GC into general maintenance mode by selecting **Maintenance > Instrument > Perform Maintenance > Start Maintenance**, and wait for the GC to become ready.
- 2 Turn off the main power switch.

WARNING

Be careful! The oven, inlet, and/or detector may be hot enough to cause burns. If they are hot, wear heat-resistant gloves to protect your hands.

Touchscreen Operation

Navigation	52
Run controls	53
Status/control tray	54
Entering Data	55
Home View	56
Flow path page	57
Status page	57
Plot page	58
Methods View	61
Diagnostics View	62
Maintenance View	63
Logs View	64
Settings View	65
Help Menu	66
Touchscreen Functionality When the GC Is Controlled by an Agilent Data System	67

This section describes the basic operation of the Agilent GC touchscreen.

Navigation

The touchscreen shows GC status and activity information (current temperatures, flows, pressures, and information about GC readiness), and allows you to start, stop, and prepare the GC to run a sample. The touchscreen also provides access to GC setpoints, real-time signals, diagnostics, maintenance information, logs, and instrument configuration settings.

The touchscreen provides access to all GC settings, controls, and information. Touch a control to access more information, to enable a setting or control, or to enter data using a touch keyboard or keypad interface, as applicable. See **Figure 9**.

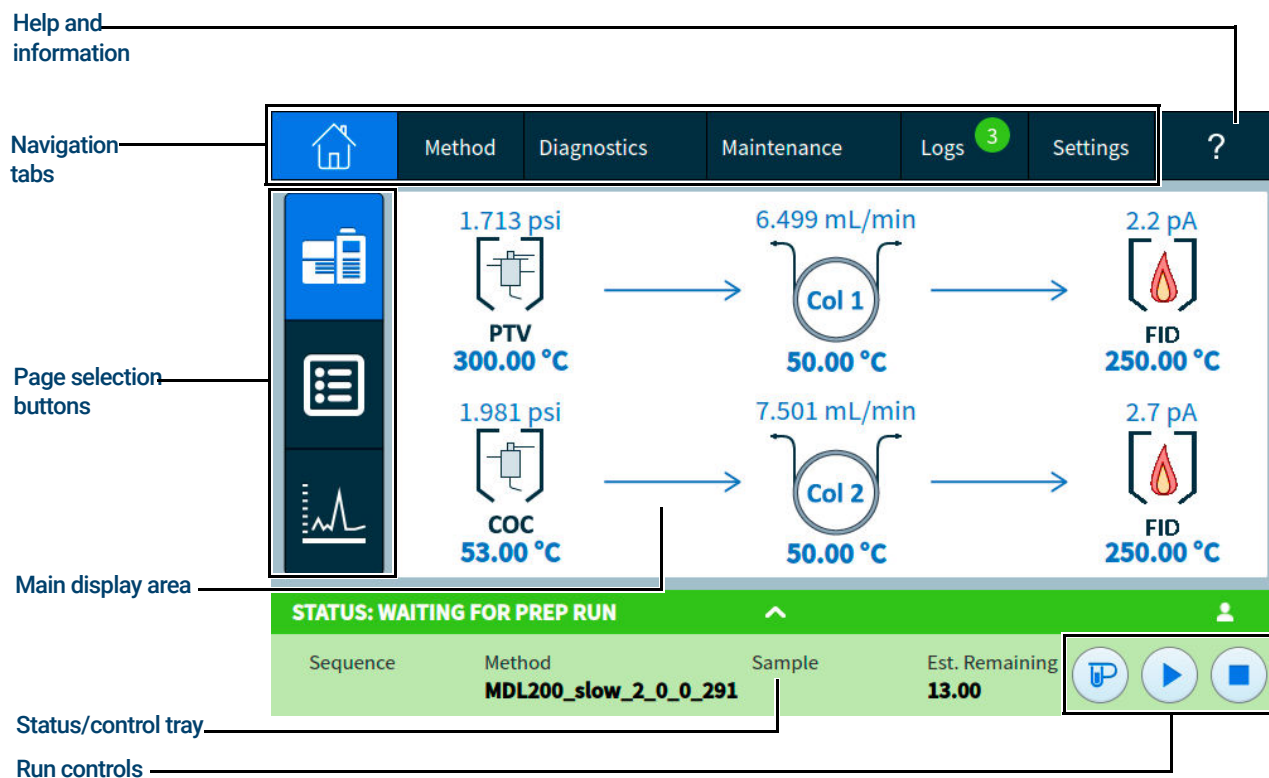

Figure 9. Touchscreen home page

The navigation tabs provide access to different functional areas. Selecting a tab brings up the corresponding panel.

The currently selected page or tab is highlighted.

Selecting the ? (help and information) tab provides access to online help and documentation for the GC.

On the home page, selecting one of the page selection buttons loads the corresponding page.

The main display area provides information related to the selected functional area/page. This area contains status displays, controls, settable parameters, and so on.

4 Touchscreen Operation

Depending on which page is selected, additional controls may appear. This can include page selection buttons, selectable tabs, back and next buttons, scroll buttons, and so on. See **Figure 10**.

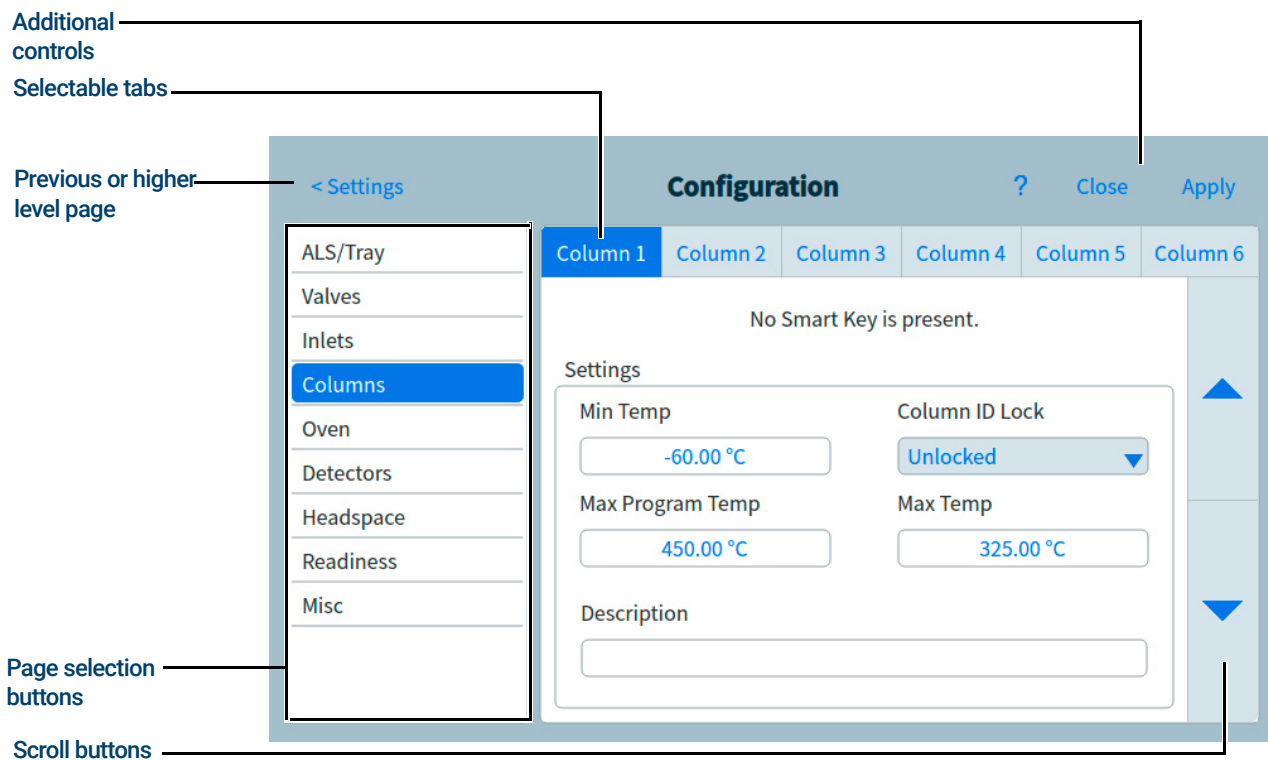

Figure 10. Additional controls

Scroll buttons are enabled if additional information or settings are available via scrolling.

Run controls

The run controls are located on the Status/control tray. The run controls are used to start, stop, and prepare the GC to run a sample.



The **Prep Run** control activates processes required to bring the GC to the starting condition for a run (such as turning off the inlet purge flow for a splitless injection). This is typically required before manual injections to exit any gas saver mode and to prepare the inlet flows for injection.



The **Start** control starts a run after manually injecting a sample. (When you are using an automatic liquid sampler or gas sampling valve, the run is automatically activated at the appropriate time.)



The **Stop** control immediately terminates the run. If the GC is in the middle of a run, the data from that run may be lost.

For details on running methods, see **“Running Methods”**.

Status/control tray

The status/control tray provides details on the current status of the GC, the current sequence and method (if connected to an Agilent data system), the time remaining for the current operation being performed by the GC, run controls, and so on.

The status/control tray is color coded to reflect the run or ready status of the GC:

- Green - Ready for a run
- Yellow - Not Ready or Shutdown
- Blue - Run in Progress
- Purple - Preparing Sample
- Teal- Sleep mode
- Red- Error

Any Early Maintenance Feedback (EMF) flags are also displayed. See **“Early Maintenance Feedback (EMF)”**.

The tray can be expanded by selecting the up arrow on the tray. See **Figure 11**.

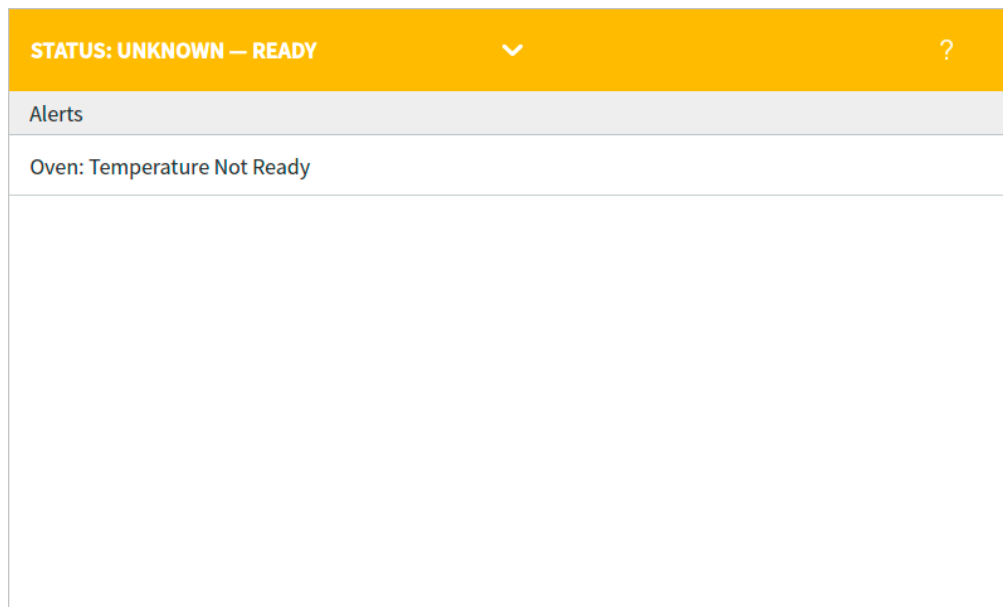

Figure 11. Status/control tray - expanded

The tray can be minimized by selecting the arrow on the tray.

Entering Data

When you touch a data entry field, a touch keyboard or keypad appears, as applicable. See **Figure 12**.

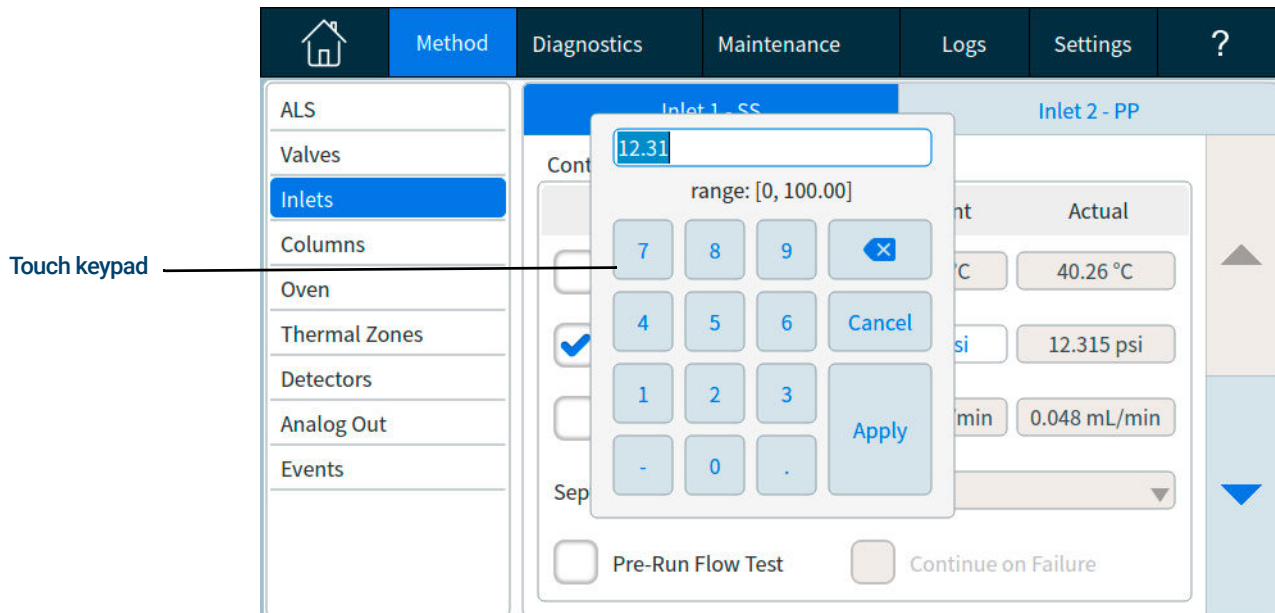

Figure 12. Touch keypad for data entry

If you enter an out of range entry, it is highlighted in a different color.

If the field is a drop-down list box (indicated by a down arrow to the right of the displayed contents of the field), select it to open the list, and then select the desired entry. See **Figure 13**.

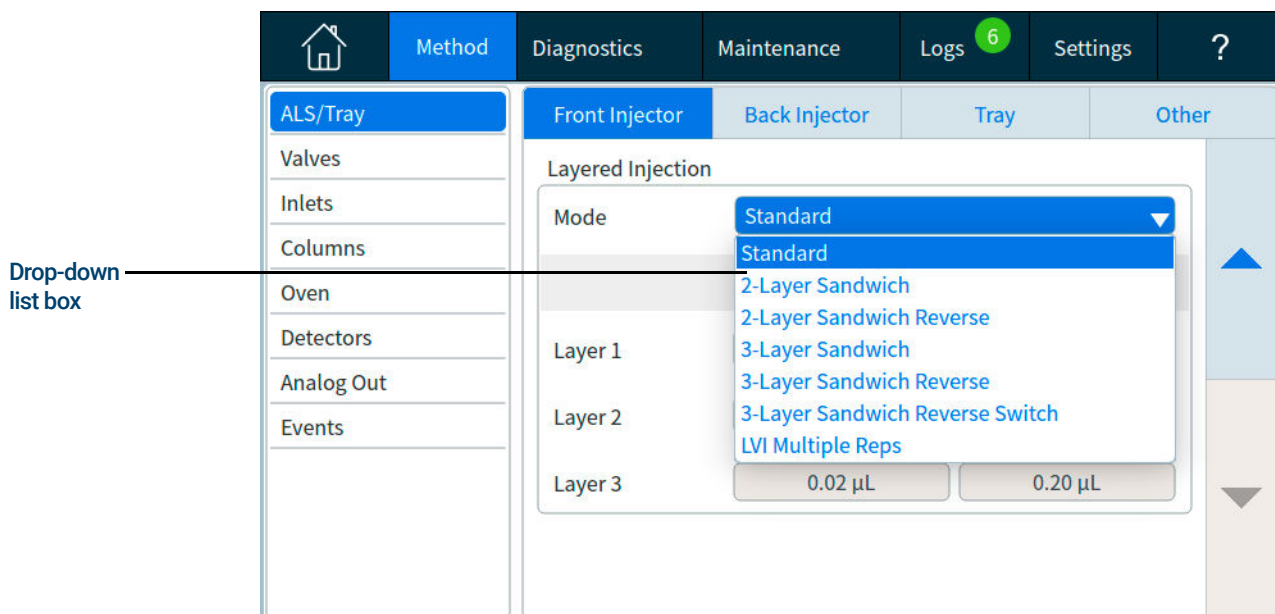

Figure 13. Drop-down list box for data entry

Home View

The home view's Flow Path page shows flow path information (including current temperatures and flow rates), run status (including user selectable status items), a real-time plot of the current chromatogram, and related information. See **Figure 14**.

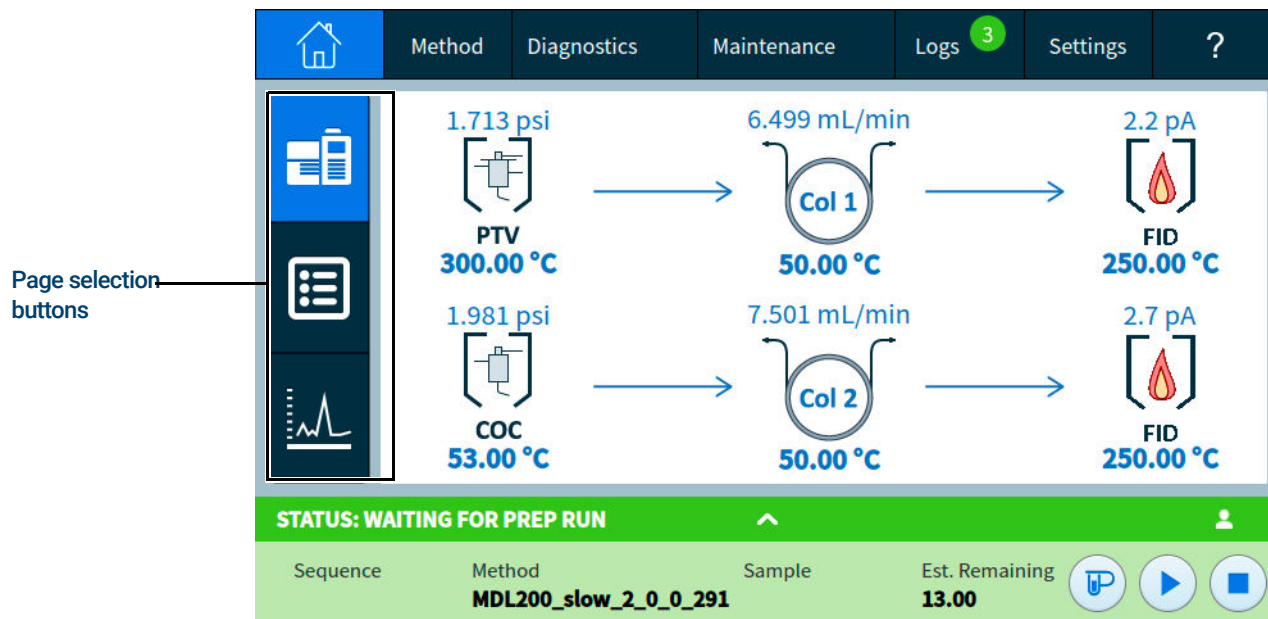

Figure 14. Home view

Three pages are available on the home view:

- Flow path
- Status
- Plot

These pages are displayed by selecting the corresponding page selection button on the left side of the home view.

Each page is described below.

Flow path page

The flow path page provides details on sample flow through the GC. This includes visual indications of whether an ALS is installed on the GC, the inlet type(s), column setup, and detector type(s), along with corresponding setpoints. See **Figure 15**.

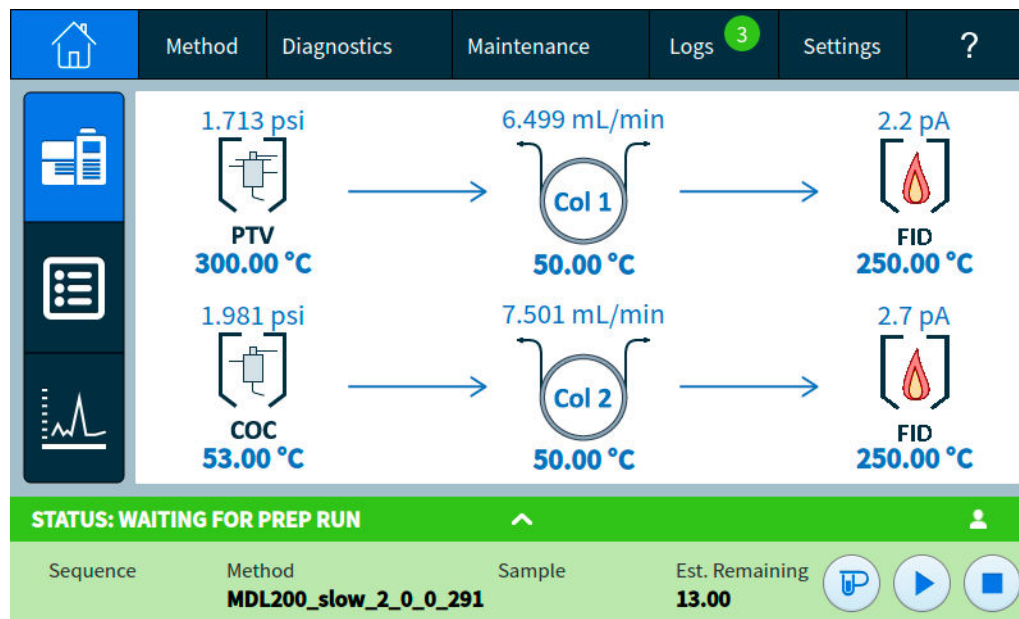

Figure 15. Home view - flow path page

Selecting a setpoint brings up the method editor with the selected setpoint displayed. If the setpoint is enabled, the keypad used to set the setpoint value is displayed.

Selecting a component, or a setpoint which is not currently enabled, brings up the method editor with the component displayed but without the keypad displayed. See **“Methods”**.

When you edit a method in this way, changes are immediately applied when a parameter value is changed, without the need to apply the changes to the GC. This is referred to as On-the-fly editing. See **“Editing the Active Method”** for more information.

Status page

The status page displays a user-selectable list of parameters, along with their setpoints and actual values. See **Figure 16**.

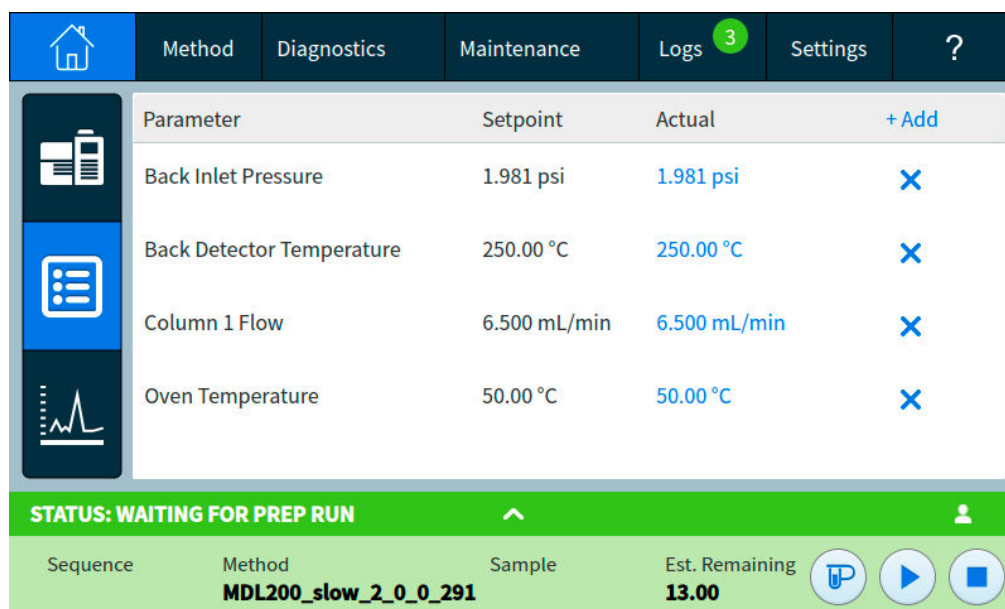

Figure 16. Home view - status page

Selecting **+ Add** brings up a dialog box which allows you to choose a parameter to add to the displayed list. See [Figure 17](#).

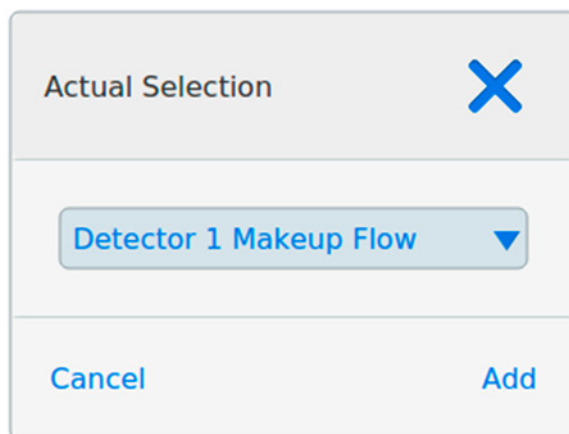

Figure 17. Status page dialog box for adding parameters

Selecting the **X** in the right side of a parameter entry brings up a confirmation dialog box that allows you to remove the corresponding parameter from the page.

Plot page

The plot page displays a plot of the currently selected signal. See [Figure 18](#).

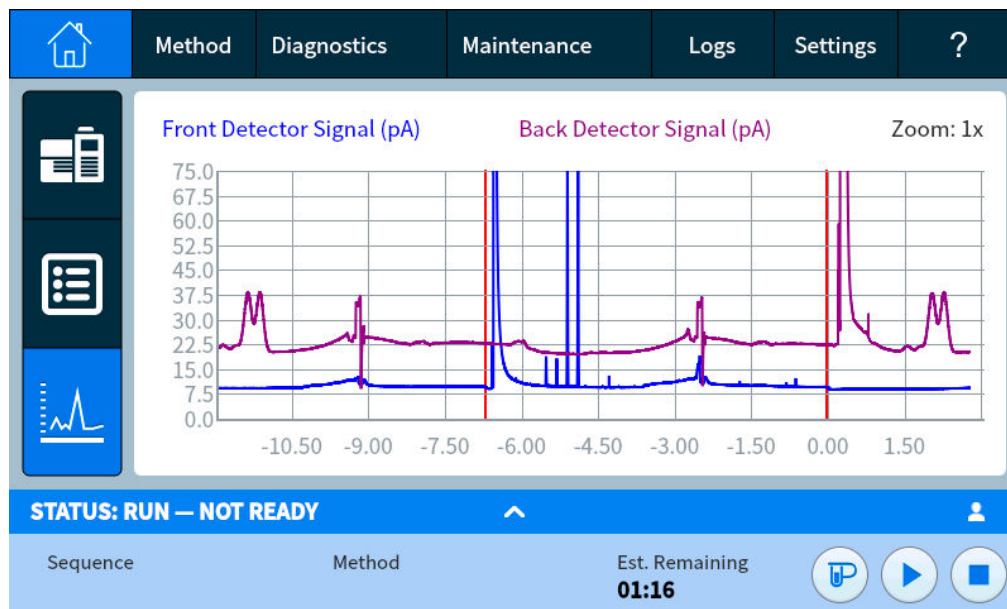

Figure 18. Home view - plot page

Clicking or tapping the plot cycles the displayed zoom between **1x**, **2x**, and **4x** at the point where the plot is clicked or tapped.

Selecting the displayed signal name opens a Plot Options dialog box. This allows you to select which signal to display. See [Figure 19](#).

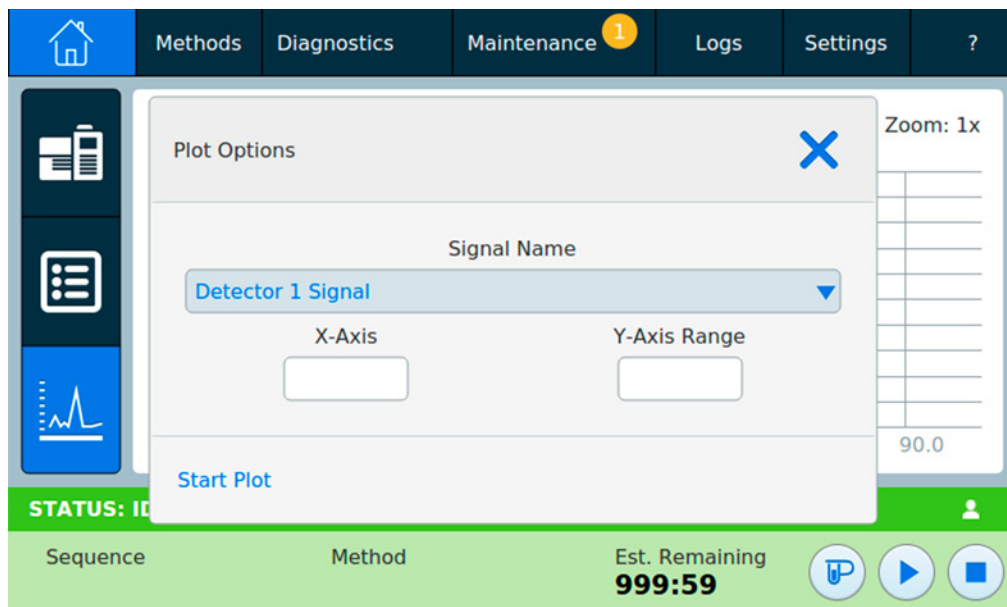

Figure 19. Plot Options dialog box

Use the **Signal Name** drop down list box to select which parameter to display on the plot.

4 Touchscreen Operation

The displayed **X-Axis** interval is 1 to 60 minutes. The **Y-Axis Range** is negative infinity to infinity. Selecting either field brings up a keypad which allows you to set the corresponding value.

If the plot is not currently running, selecting **Start Plot** starts it. If the plot is currently running, selecting **Stop Plot** halts data collection and display. (When changing the Signal Name, it may be necessary to select **Stop Plot** and then **Start Plot** to display the signal.)

Methods View

From the touchscreen, the Methods view provides access to the method currently being used (Active Method). Use this view to edit the Active Method. From the Browser Interface, The Methods view provides access to the locally-stored methods, including the method currently being used (Active Method).

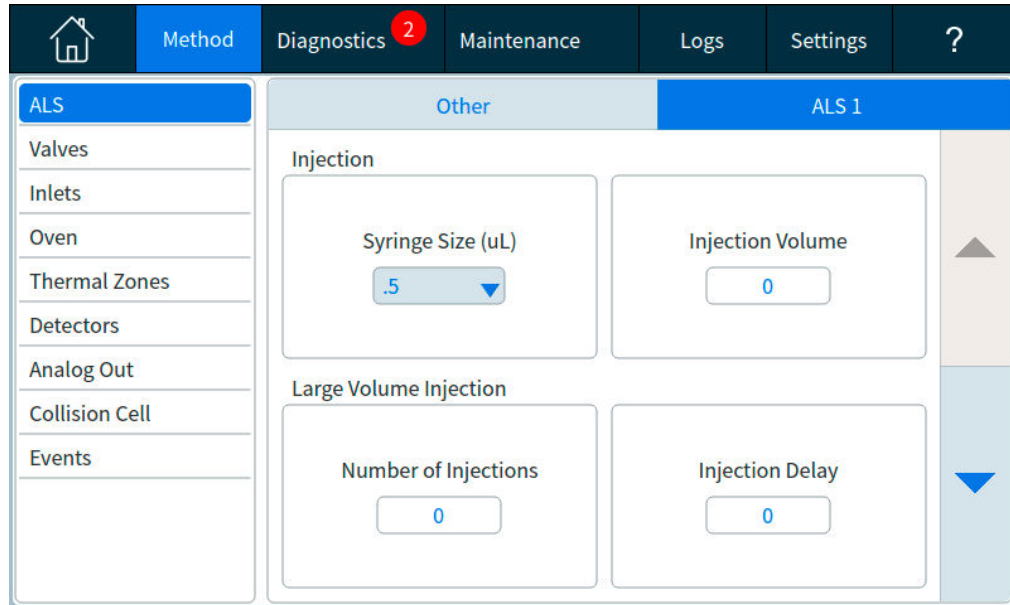

Figure 20. Methods view

Selecting **Edit** brings up the method editor for the Active Method. See “**Methods**” for more details.

Diagnostics View

The Diagnostics view provides access to diagnostic tests for the installed inlet and detectors, as well as access to the System Health Report.

Additionally, the view provides a list of all current alerts.

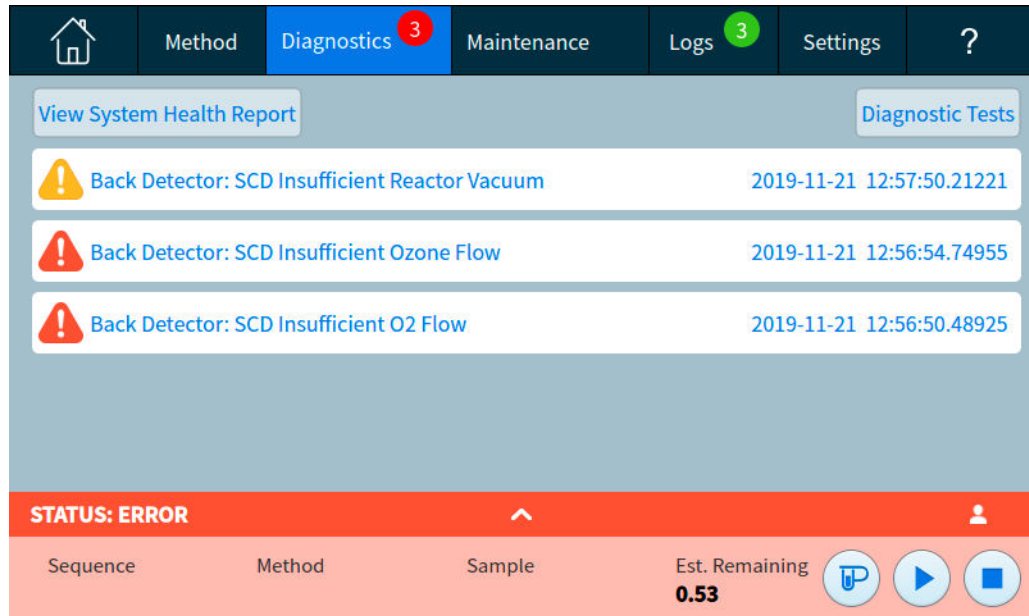

Figure 21. Diagnostics view

See “Diagnostics” for details.

Maintenance View

The Maintenance View provides access to the Agilent GC Early Maintenance Feedback (EMF) features. See **Figure 22**.

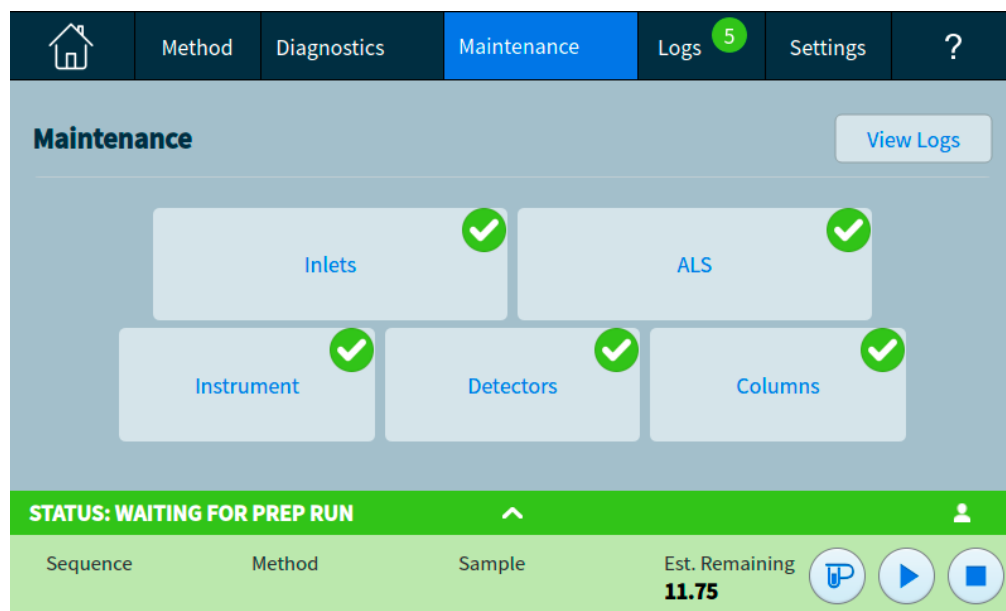

Figure 22. Maintenance view

EMF provides injection-based, run-based, and time-based counters for various consumable and maintenance parts, as well as the instrument itself. Use these counters to track usage of GC components. Replace or recondition items before potential degradation impacts chromatographic results.

The Maintenance view provides visual indications of maintenance status and is used to track and perform maintenance tasks.

The **View Logs** button brings up the Maintenance Log from the Logs view. See **“Logs”**.

Logs View

The Logs view provides listings of GC events including maintenance events, run events, and system events, sorted by date/time. See **Figure 23**.

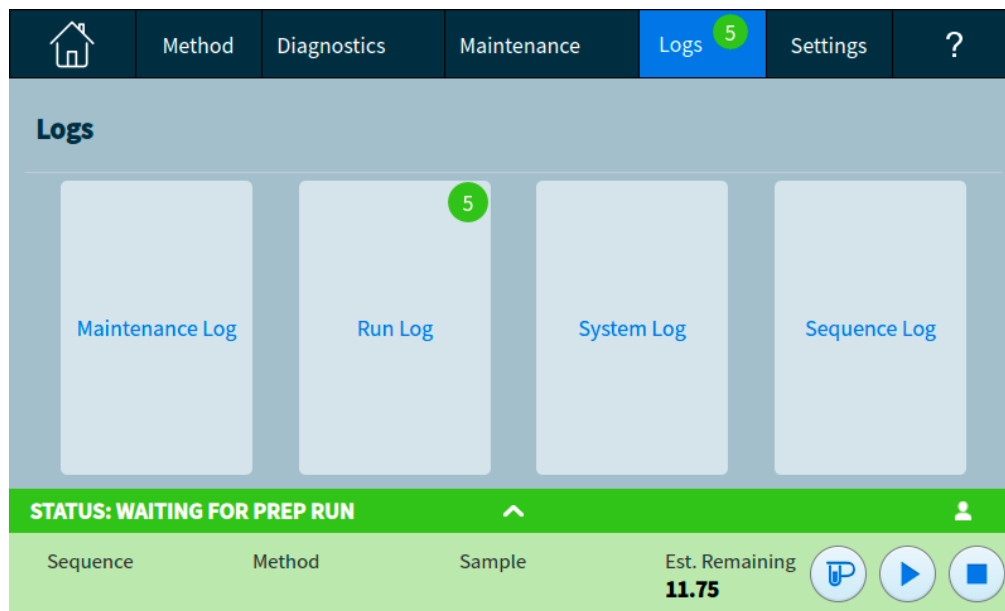

Figure 23. Logs view

See **“Logs”** for more details.

Settings View

The Settings View provides access to instrument configuration functions, scheduler functions, service mode settings, calibration settings, system settings, system tools, power controls (restart or shutdown) and system details. See **Figure 24**.

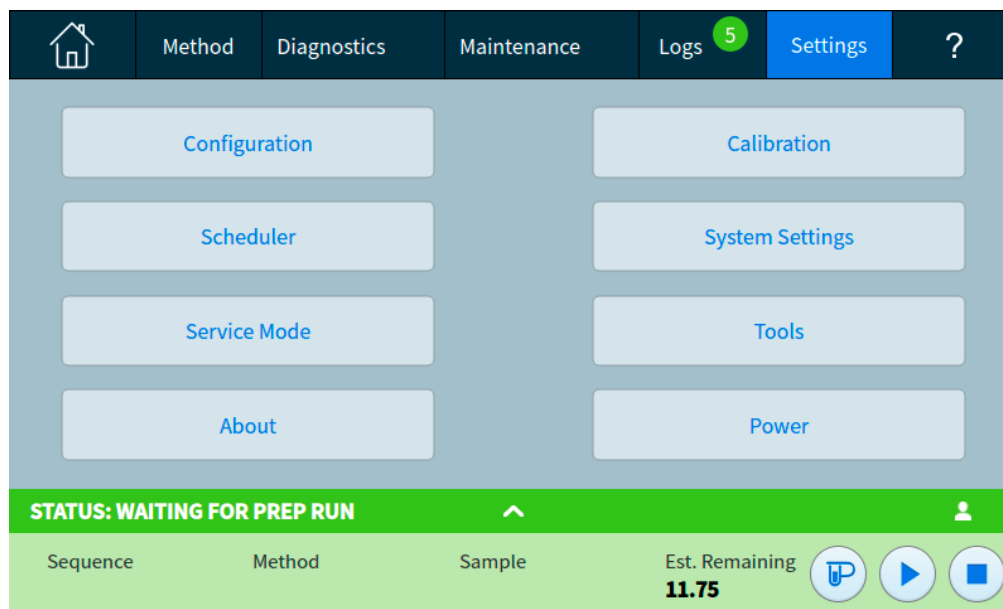
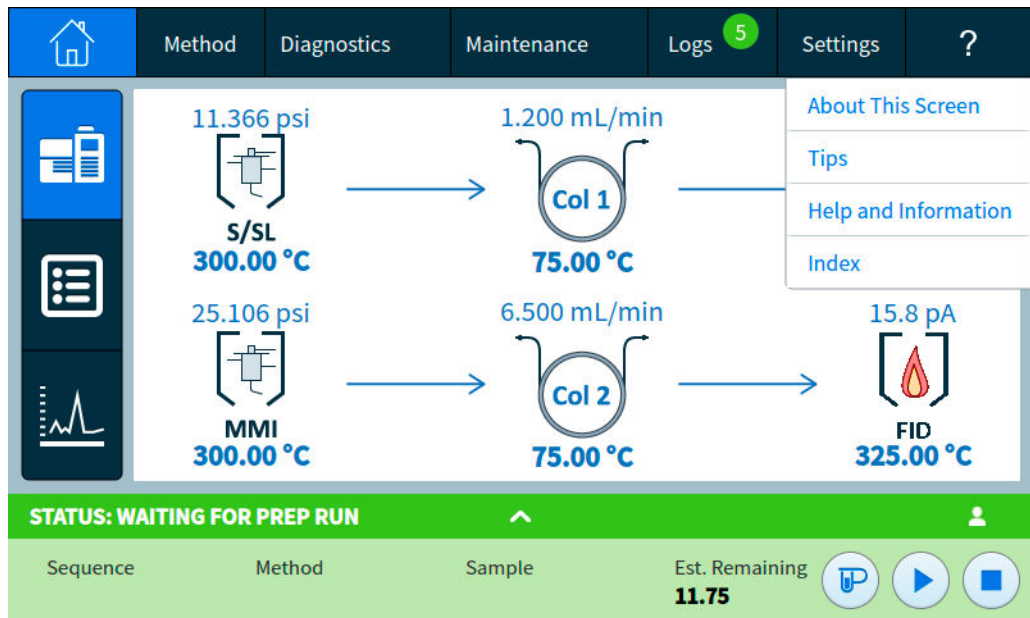

Figure 24. Settings view

See **"Settings"** for more details.

Help Menu

The Help view can be accessed by selecting the ? tab. From here, you can access a full Help and Information suite, additional information about the screen you are currently viewing, and more. See **“Touchscreen Help”** for more information on what each option in the dropdown menu provides.



Touchscreen Functionality When the GC Is Controlled by an Agilent Data System

When an Agilent data system controls the GC, the data system defines the setpoints and runs the samples. If configured to lock the touchscreen, the data system can prevent the changing of setpoints.

When an Agilent data system controls the GC, the touchscreen can be used:

- To view run status by selecting the **Home** view
- To view the method settings by using the **Method** view
- To display the last and next run times, the run time remaining, and the post-run time remaining
- To abort a run

Stopping a run using the touchscreen or Browser Interface immediately ends the run. The data system may retain the data already collected, but no further data is collected for that sample. Agilent data systems may allow the next run to begin, depending on the data system and its settings for handling errors.

What is a Method?	70
What Is Saved in a Method?	71
What Happens When You Load a Method?	72
Editing the Active Method	73
Create a Method	74
Load a Method	75
Running Methods	76
Events	78
Inlets	80
About gas saver	81
To set the PTV or COC coolant parameters	81
To set MMI coolant parameters	82
About Oven Temperature Programming	84
Columns	87
Nickel Catalyst Tube	88
Detectors	89
FID	89
FPD+	90
NPD	91
TCD	93
ECD	94
Valves	95
The valve box	95
Valve control	95
Valve types	97
Controlling a valve	97
GC Output Signals	101
Analog signals	101
Digital signals	103
Column compensation	106
Test plot	107

What is a Method?

A method is the group of settings required to analyze a specific sample.

Since every type of sample reacts differently in the GC—some samples require a higher oven temperature, others require a lower gas pressure or a different detector—a unique method must be created for each specific type of analysis.

The GC also can store several specialized methods. The GC stores three methods used for resource conservation, called **SLEEP**, **CONDITION**, and **WAKE**. When configured for use with an attached MS, the GC also provides a method called **MS VENT**, used to change GC setpoints to values appropriate for a safe MS venting process. Create these methods using an Agilent data system. See **“Resource Conservation”** for more information about these specialized methods.

Methods can be created and edited using the Browser Interface. Methods can also be created, edited, and stored on a connected data system. While a data system is connected to your GC, any attempt to connect to your GC via the Browser Interface will result in the Browser Interface having limited functionality. You will not be able to edit methods, edit sequences, and start or stop runs until the data system is disconnected. Similarly, once a Browser Interface is connected to your GC, any subsequent Browser Interfaces attempting to connect will not be able to edit methods, edit sequences, and start or stop runs until the first session is disconnected.

Methods and sequences created using the Browser Interface are not directly accessible from a connected data system. Methods and sequences created using a connected data system are not directly accessible using the Browser Interface.

What Is Saved in a Method?

Some of the settings saved in a method define how the sample will be processed when the method is used. Examples of method settings include:

- The oven temperature program
- The type of carrier gas and flows
- The type of detector and flows
- The type of inlet and flows
- The type of column
- The length of time to process a sample

Setpoint parameters can be stored for the components shown in **Table 2**.

Table 2 Setpoint parameter components

Component	Component
Oven	Aux temp
Valve 1–8	Aux EPC
Front and back inlet	Aux column
Columns 1 to 6	Aux detector 1 and 2
Detectors 1–4	Post run
Analog 1 and 2	Run table
Front and back injector	Sample tray

Data analysis and reporting parameters are also stored in a method when it is created on an Agilent data system, for example OpenLAB CDS or MassHunter software. These parameters describe how to interpret the chromatogram generated by the sample and what type of report to print.

The GC method also includes sampler setpoints. Refer to the sampler documentation for details on setpoints for the supported device:

- For the 7650A ALS, see its Installation, Operation, and Maintenance manual.
- For the 7693A ALS, see its Installation, Operation, and Maintenance manual.
- For the 7697A HS, see its Installation and First Startup manual and Operation manual.
- For the CTC PAL3 AS, see its Installation and First Startup manual and Operation manual.

Current setpoint parameters are saved when the GC is turned off, and loaded when you turn the instrument back on.

What Happens When You Load a Method?

There are two kinds of methods:

- The active method—This is sometimes referred to as the current method. The settings defined in this method are the settings the GC is currently maintaining.
- Stored methods—User-created methods can be stored in the GC, along with one SLEEP method, one WAKE method, one CONDITION method, an MS VENT method, and a default method.

When a method is loaded from the data system, or when a method is applied from the Browser Interface, the setpoints of the Active Method are immediately replaced with the setpoints of the method loaded.

- The method loaded becomes the active (current) method.
- The GC front panel status indicator will be yellow (not ready) and will stay yellow until the GC reaches all of the settings specified by the method that was just loaded.

Editing the Active Method

The Active Method is the current collection of setpoints being used by the GC. Using the touchscreen you can edit these settings, and any changes apply immediately. When you download a method from the Browser Interface or an Agilent data system, that method becomes the new Active Method.

The Active Method setpoint parameters are stored when the GC is turned off, and loaded when you turn the instrument back on.

The Active Method cannot be saved from the touchscreen, however, you can upload the current GC settings into the Browser Interface or Agilent data system, and then save them as a new method.

To edit the active method

- 1 Individually select each component for which setpoint parameters are appropriate for your method. See [Table 2](#).
- 2 Examine the current setpoints and modify as desired. Repeat for each component as appropriate.
- 3 Examine the current setpoints for the ALS, if appropriate, and modify as desired.
- 4 Changes you make to the active method are automatically applied to the GC.

GC hardware changes

When you change the hardware your GC is using, your GC will use the default settings for the new components. Before operating your GC with its new components, check and update the relevant settings as needed.

Create a Method

Methods may be created using your Agilent data system, or via the Browser Interface. For more information on creating a method using your data system, refer to the documentation provided with your data system.

From the Browser Interface:

- 1 Click **Method** on the control ribbon.
- 2 Click the **Create New** button . You are prompted to name your method and save.
- 3 From the navigation tree, select each instrument device, and set its method parameters to the desired values.
- 4 Click **Configuration > Modules**. Check the gas configuration for each inlet and detector. (Gas configuration was initially set when the Setup Wizard was run at installation.) Make any changes if needed.
Click **Configuration > Columns**. If the installed columns include Smart ID Keys, the column configurations are set by the Smart ID Keys. If not, edit the column configuration as needed. Double-click a column to edit it.
- 5 Click **Columns**. For each column, set the control mode, select the **On** checkbox, and set the flow on the column.
- 6 Click **Inlets**, and then select either the front or back inlet. Set the inlet mode, temperatures, and other parameters needed for your method. Repeat for the other inlet, if present.
- 7 Click **Detectors**. For each detector being used, set the detector temperature and gas flows. Select all check boxes to turn the detector on.

NOTE

Carrier Gas Flow Correction setting recommendations

- **Column + Fuel = Constant** (H₂ carrier in Constant Pressure mode)
- **Column + Makeup = Constant** (He/N₂ carrier Constant Pressure mode)
- **Constant Makeup and Fuel Flow** (any carrier in Constant Flow mode)



- 8 Click **Oven**. Set the initial oven temperature, ramp temperatures, and times for your method. Select the **Heater On** checkbox. For an isothermal run, do not create any ramps.
- 9 Click **Signals**. Choose the signals to be included in the data file when a run is initiated. Normally this is **Front Signal** or **Back Signal** for detector output. Select the Save check box and select a data rate that meets the needs of your chromatography.
- 10 Click **ALS/Tray**, then select either the front or back injector. Set the **Injection Volume**, washes, and pumps.

NOTE

It is important to do both sample and solvent washes to eliminate carryover and keep the syringe clean. Pumping the plunger multiple times eliminates air bubbles in the syringe for better reproducibility.

- 11 If using a tray, click **ALS/Tray > Other**. Set **Sample Overlap** if desired.
- 12 Click the **Save** button  to save your method.

Load a Method

- 1 Connect to the GC using the Browser Interface. See **“Browser Interface”**.
- 2 Open or create the desired method. See **“Create a Method”**.
- 3 If needed, click the **Save** button  to save the method.
- 4 Click the **Download** button  to load the method to your GC.

Running Methods

Pre Run and Prep Run

With some inlets and operating modes, certain instrument setpoints are different between runs than during an analysis. To restore the setpoints for injection, you must place the GC into the Pre Run state.

You must use the Pre Run state when:

- Using gas saver with any inlet.
- Using splitless mode with any inlet.
- Using a pressure pulse mode with any inlet.
- Using the solvent vent mode of the PTV inlet.
- Using the direct or splitless mode of the Volatiles Interface.
- Using the solvent vent mode of the MMI inlet.
- Using the direct mode of the MMI inlet.

There are three ways to begin Pre Run—manually (select  before each run), automatically (for Agilent samplers), or using **Auto Prep Run** (for non-Agilent samplers). The three methods are discussed below.

During the Pre Run state:

- The status on the touchscreen changes to indicate the GC is preparing for the injection.
- Setpoints change to the correct values for injection.
- Inlet, detector, and oven equilibration times begin.

When all criteria for a run are met, the Status/Control tray indicates that the GC is ready for sample injection.

Manually prepare for the run

Select  before you inject a sample manually. The GC enters the Pre Run state. When the touchscreen indicates that the GC is ready, begin the analysis.



If you are using an Agilent automatic sampling system, the **Prep Run** function is automatic.

Non-Agilent samplers

With most automatic injection systems, you do not need to use the  button. If your sampler or automation controller (for example, an integrator or workstation) does not support the **Prep Run** function, you must set the GC to **Auto Prep Run**.

To manually inject a sample with a syringe and start a run

- 1 Prepare the sample syringe for injection.
- 2 Load the desired method. See **“Load a Method”**.

- 3 Navigate to the **Home** view and select **Prep Run** . See **“Run controls”** for more information.
- 4 Wait for status **Ready** to display.
- 5 Insert the syringe needle through the septum and all the way into the inlet.
- 6 Simultaneously depress the syringe plunger to inject the sample and select **Start** .

To run a method to process a single ALS sample

- 1 Prepare the sample for injection.
- 2 Load the sample vial into the assigned location in the ALS tray or turret.
- 3 Load the desired method. (See **“Load a Method”**.)
- 4 Navigate to the **Home** view and select **Start**  to initiate the ALS syringe cleaning, sample loading, and sample injection method. After the sample is loaded into the syringe, the sample is automatically injected when the GC reaches the ready state. See **“Run controls”** for more information.

To abort a method

- 1 Select **Stop** .
- 2 When you are ready to resume running analyses, load the appropriate sequence or method. (See **“Load a Method”**.)

Events

Run time programming during a method allows certain setpoints to be changed during a run as a function of the chromatographic run time. Thus an event that is programmed to occur at 2 minutes will occur 2 minutes after every injection.

- Controlling column switching or other valves
- Changing analog signal definition, zero, or range
- Controlling an auxiliary pressure channel
- Changing polarity of a thermal conductivity detector (TCD)
- Make sample flow bypass TCD filament
- Turning the hydrogen flow to a nitrogen-phosphorus detector (NPD) on or off
- Switching digital signal output (requires an Agilent data system)
- Pausing (“freezing”) and resuming digital signal output (requires an Agilent data system)
- Performing signal math on the front and back detectors.

The changes are entered into a run table that specifies the setpoint to be changed, the time for the change, and the new value. At the end of the chromatographic run, most setpoints changed by a run time table are returned to their original values.

Valves can be run time programmed but are not restored to their starting position at the end of the run. You must program the reset operation in the run table if this action is desired.

Using run time events

The **Events** page in the **Method** tab is used to program the following timed events.

- Valves (1-10)
- Multiposition valve
- Signal type
- Analog signal definition, zero, and range
- Auxiliary pressures (1 through 9)
- TCD negative polarity (on/off)
- Detector gas flow (on/off), including NPD H₂ fuel gas
- Inlet septum purge flow
- AO signal range
- AO signal source
- AO signal zero
- Bypass TCD Filament

Programming run time events

- 1 Select **Method**.
- 2 Select **Events**.
- 3 Input the time at which you want the event to occur, select the event you want to program, select the position of the hardware that is being controlled, and set the desired setpoint.

The run table

The programmed events are arranged in order of execution time in the Run Table.

Editing events in the run table

- 1 Select the event you wish to edit. If the desired event is not immediately visible, use the up and down arrows to the right to scroll up and down the table until it is.
- 2 Select the parameter you want to change.
- 3 Input the new value

Deleting run time events

- 1 Select the event you wish to delete.
- 2 Select **Delete**.

Inlets

The Inlets page in the Method tab is used to modify the method parameters and each inlet connected to your GC. Common parameters include the heater temperature and inlet pressure. See **Figure 25**. To modify your inlets' method parameters:

- 1 Select **Method > Inlets**.
- 2 Select the inlet you want to modify.
- 3 Scroll to the desired setting, and edit as necessary.

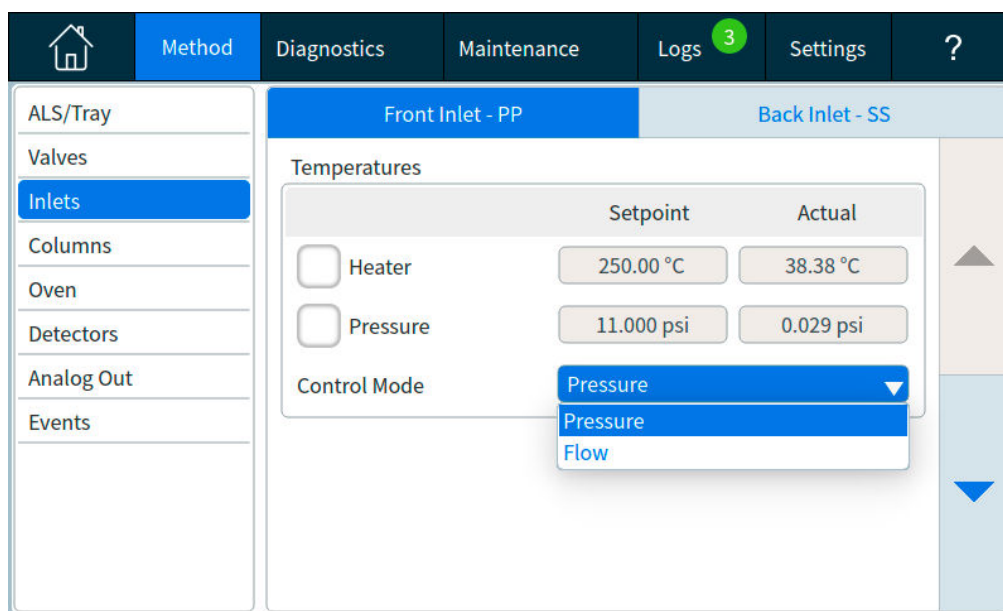

Figure 25. Common Inlet parameters

Carrier gas flow rates

The flow rates in **Table 3** are recommended for all column temperatures.

Table 3 Column size and carrier flow rate

Column type	Column size	Carrier flow rate, mL/min		
		Hydrogen	Helium	Nitrogen
Packed	1/8-inch		30	20
	1/4-inch		60	40
Capillary	0.05 mm id	0.5	0.4	n/a
	0.10 mm id	1.0	0.8	n/a
	0.20 mm id	2.0	1.6	0.25
	0.25 mm id	2.5	2.0	0.5
	0.32 mm id	3.2	2.6	0.75
	0.53 mm id	5.3	4.2	1.5

About gas saver

Gas saver reduces carrier flow from the split vent after the sample is on the column. It applies to the Split/Splitless, Multimode, and PTV inlets (all modes) and to the split and splitless modes of the Volatiles Interface. It is most useful in split applications.

Column head pressure and flow rate are maintained, while split vent flows decrease. Flows—except column flow—remain at the reduced level until you press .

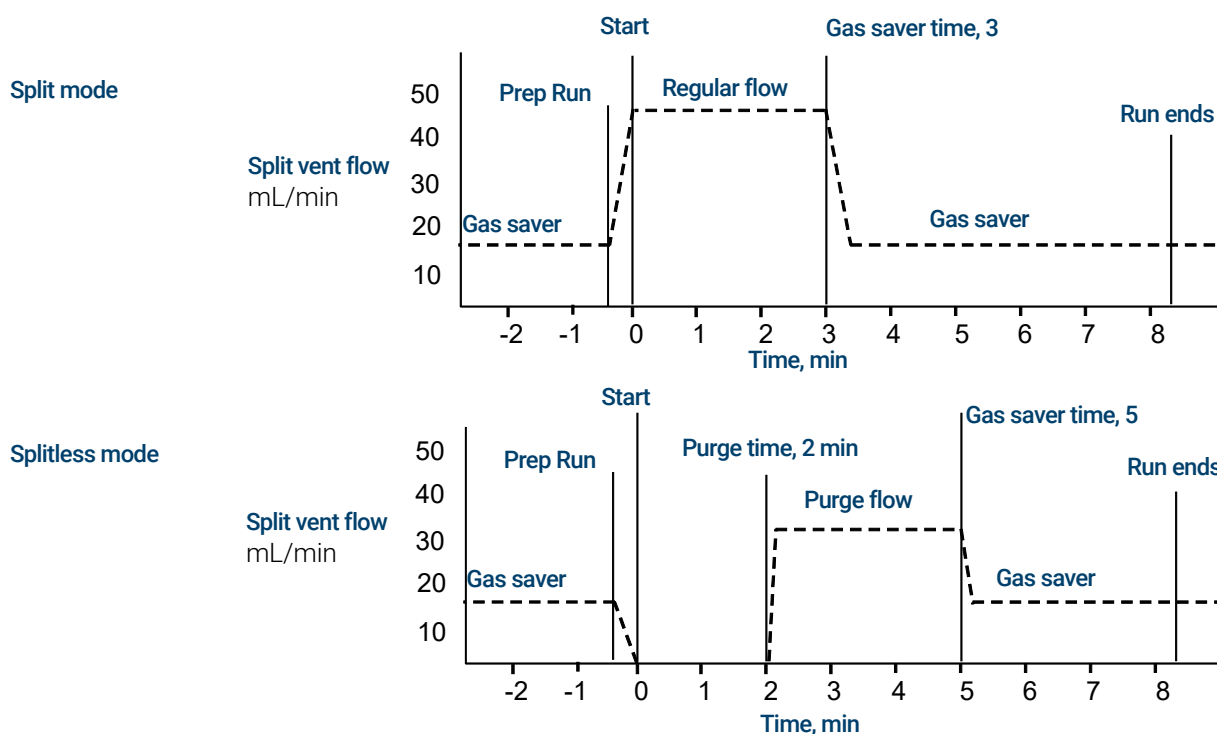

The pulsed modes of the split/splitless, multimode, and PTV inlets are similar except for the pressure pulse starting at  and ending at **Pulse time**.

To use gas saver

- 1 Select **Method** > **Inlets**.
- 2 Scroll down until the Gas Saver option is visible.
- 3 Select the checkbox next to **Gas Saver** to enable it.
- 4 Input the **Setpoint**. The setpoint must be at least 15 mL/min greater than the column flow.
- 5 Input the **Time**.

To set the PTV or COC coolant parameters

Select **Method** > **Inlets**. Use the down arrow to scroll until the cryo settings are visible

Cryo Cooling Selecting the checkbox next to Cryo Cooling enables cryogenic cooling of the inlet at the specified **Cryo use temperature** setpoint. Deselecting the checkbox disables cooling.

Fast Cooldown This feature is separate from **Cryo Cooling**. Fast Cooldown makes the oven cool faster after a run than it would without assistance. This feature is useful when maximum sample throughput is necessary, however it does use more coolant. Fast Cooldown turns off soon after the oven reaches its setpoint and Cryo Cooling takes over, if needed.

Fault Detection Shuts down the inlet temperature if it does not reach setpoint in 16 minutes of continuous cryo operation. Note that this is the time to *reach* the setpoint, not the time to stabilize and become ready at the setpoint

Cryo Use Temperature This setpoint determines the temperature at which cryogenic cooling is used continuously. The inlet uses cryogen to achieve the initial setpoint. If the initial setpoint is below the **Cryo Use Temperature**, cryogen is used continuously to achieve and maintain the setpoint. Once the inlet temperature program starts, the cryogen will be turned off when the inlet exceeds the **Cryo Use Temperature**. If the initial setpoint is above the **Cryo Use Temperature**, cryogen is used to cool the inlet until it reaches the setpoint and then it is turned off. At the end of a run, the inlet waits until the oven becomes ready before it uses cryogen.

If the inlet is to be cooled during a run, cryogen will be used to achieve the setpoint. This may have a negative impact on the chromatographic performance of the oven and cause distorted peaks.

Timeout Detection Use this setting to conserve cryogenic fluid. If selected, the instrument shuts down the inlet and cryogenic (subambient) cooling (if installed) when no run starts in the number of minutes specified. The setpoint range is 2 to 120 minutes (default 30 minutes). Turning cryo timeout off disables this feature. We recommend cryo timeout enabling to conserve coolant at the end of a sequence or if automation fails. A Post Sequence method could also be used.

To set MMI coolant parameters

Select **Method > Inlets**. Use the down arrow to scroll until the cryo settings are visible

Cryo Cooling Selecting the checkbox next to Cryo Cooling enables cryogenic cooling of the inlet at the specified **Use cryo temperature** setpoint, Deselecting the checkbox disables cooling.

Fast Cooldown This feature is separate from **Cryo**. Fast Cooldown makes the oven cool faster after a run than it would without assistance. This feature is useful when maximum sample throughput is necessary, however it does use more coolant. Cryo Cooling turns off soon after the oven reaches its setpoint and Cryo Cooling takes over, if needed.

Fault Detection This parameter is available with **N2 cryo** and **CO2 cryo** Cryo types. Shuts down the inlet temperature if it does not reach setpoint in 16 minutes of continuous cryo operation. Note that this is the time to *reach* the setpoint, not the time to stabilize and become ready at the setpoint.

Cryo Use Temperature If **N2 cryo** or **CO2 cryo** is the Cryo type, this setpoint determines the temperature below which cryogenic cooling is used continuously to hold the inlet at setpoint. Set the **Cryo Use Temperature** equal to or higher than the inlet setpoint to cool the inlet and hold the setpoint until the inlet temperature program exceeds the **Cryo Use Temperature**. If the **Cryo Use Temperature** is less than the inlet setpoint, cryogen will cool the inlet to the initial setpoint and turn off.

Timeout Detection This parameter is available with **N2 cryo** and **CO2 cryo** Cryo types. Use this setting to conserve cryogenic fluid. If selected, the instrument shuts down the inlet and cryogenic cooling when no run starts in the number of minutes specified. The setpoint range is 2 to 120 minutes (default 30 minutes). Turning cryo timeout off disables this feature. We recommend cryo timeout enabling to conserve coolant at the end of a sequence or if automation fails. A Post Sequence method could also be used.

Use cryo temperature behaves differently in Compressed air mode than it does in N2 cryo or CO2 cryo mode. In Compressed air mode, the air coolant is used to cool the inlet regardless of the **Use cryo temperature** setpoint during the cooling cycle. If the inlet reaches setpoint, the air coolant is turned off and stays off. If the oven temperature is high enough, or the inlet was very hot previously, it is possible that the inlet temperature will rise and the GC will go not ready. For this reason, it is better to set the instrument cooling configuration as N2 cryo, or CO2 cryo, using compressed air as the coolant. Using compressed air, the LN₂ hardware cools the inlet faster than the LCO₂ hardware.

Never use LCO₂ or LN₂ as your coolant while the instrument is configured in Compressed air mode.

About Oven Temperature Programming

You can program the oven temperature from an initial temperature to a final temperature using up to 20 ramps during a run.

A single ramp temperature program raises the initial oven temperature to a specified final temperature at a specified rate and holds at the final temperature for a specified period of time.

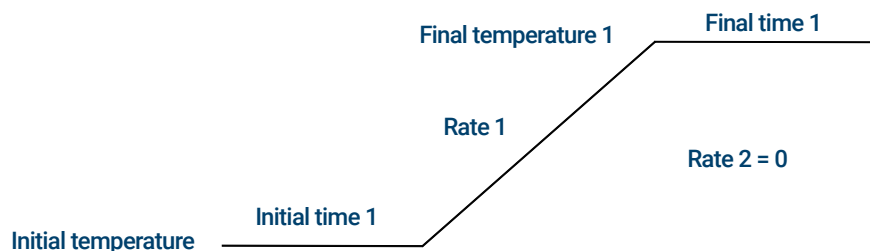

The multiple-ramp temperature program is similar. You can program the oven from an initial temperature to a final temperature, but with various rates, times, and temperatures in between. Multiple ramps can also be programmed for temperature decreases as well as increases.

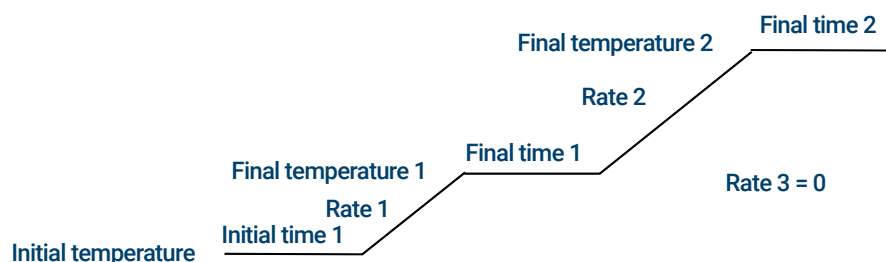

Oven ramp rates

To use the fast oven ramp rates (a 240 V power option is required), your electric service must be able to supply ≥ 200 V at ≥ 15 Amp.

The highest rate that you can achieve depends on many factors, including the room temperature, temperatures of the inlets and detectors, the amount of material inside the oven (columns, valves, etc.), and whether or not this is the first run of the day.

The optional oven insert for fast chromatography (see [“About the Oven Insert”](#)), increases oven ramp rates for the back column. [Table 4](#) lists typical oven ramp rates.

Table 4 Oven ramp rates

Temperature range (°C)	100/120 V oven ramp rate (°C/minute)		200/220/230/240 V oven ramp rate (°C/minute)	
	Without insert	With optional insert	Without insert	With optional insert
50 to 70	75	120	120	120

Table 4 Oven ramp rates (continued)

Temperature range (°C)	100/120 V oven ramp rate (°C/minute)		200/220/230/240 V oven ramp rate (°C/minute)	
	Without insert	With optional insert	Without insert	With optional insert
70 to 115	45	95	95	120
115 to 175	40	65	65	110
175 to 300	30	45	45	80
300 to 450	20	35	35	65

Isothermal runs

An isothermal run is one in which the oven is maintained at a constant temperature. For an isothermal run, set Rate 1 to zero.

- 1 Select **Oven** to open the oven parameter list.
- 2 Enter the oven temperature for the isothermal run.
- 3 Enter the number of minutes (Initial time) that you want the oven to stay at this temperature. This time is the duration of the run.
- 4 If Rate 1 is not already 0, enter zero for an isothermal run

Oven cryogenic cooling parameters

All cryogenic setpoints are found in **Method > Oven**.

Cryo Cooling Select or deselect this checkbox to enable or disable cryogenic cooling respectively.

Quick cool This feature is separate from **Cryo**. Quick cool makes the oven cool faster after a run than it would without assistance. This feature is useful when maximum sample throughput is necessary, however it does use more coolant. Quick cool turns off soon after the oven reaches its setpoint and Cryo takes over, if needed.

Ambient Temperature The temperature in the laboratory. This setpoint determines the temperature at which cryogenic cooling is enabled:

- Ambient temp + 25°C, for regular cryo operation
- Ambient temp + 45°C, for Quick Cryo Cool.

Timeout Detection Cryo timeout occurs, and the oven shuts off, when a run does not start within a specified time (10 to 120 minutes) after the oven equilibrates. Turning cryo timeout off disables this feature. We recommend that it be turned on because cryo timeout conserves coolant at the end of a sequence or if automation fails. A Post Sequence method could also be used.

Fault Detection Shuts the oven down if it does not reach setpoint temperature after 16 minutes of continuous cryo operation. Note that this is the time to *reach* the setpoint, not the time to stabilize and become ready at the setpoint. For example, with a cool on-column inlet and cryo control in the oven track mode, it may take the oven 20 to 30 minutes to achieve readiness.

If the temperature goes below the minimum allowed temperature (-90°C for liquid nitrogen, -70°C for liquid CO_2), the oven will shut down.

The COC, MMI, and PTV inlets must use the same cryo type as configured for the oven.

Columns

The column flow mode determines whether pressure or flows are available as setpoints for the GC inlets. When all columns in the flow path are defined, you can enter pressures or flows. If any column in the flow path is not defined, then the settings for the inlet may be restricted based on the inlet type and whether the column is in flow or pressure mode.

There are two different flow modes that control the mass flow rate through the column: **Constant flow** and **Ramped flow**. The flow rates are corrected to NTP (normal temperature and pressure, 25 °C and 1 atmosphere).

There are two different pressure modes that control the pressure at the head of the column; **Constant pressure** and **Ramped pressure**. These pressures are gauge pressures—the difference between the absolute pressure and the local atmospheric pressure.

Constant flow Maintains a constant mass flow rate of carrier gas in the column throughout the run. If the column resistance changes due to a temperature program, the column head pressure is adjusted to keep the flow rate constant. This can shorten runs significantly.

Ramped flow Increases the mass flow rate in the column during the run according to a program you enter. A column flow profile can have up to three ramps, each consisting of a programmed increase followed by a hold period.

The pressure modes are not available if the column is not defined or the inlet's mode is set to Flow control. Pressures are gauge pressures—the difference between the absolute pressure and the local atmospheric pressure.

Because most detectors present little resistance to the column flow, the gauge pressure at the column head is usually the same as the pressure difference between column inlet and exit. The mass selective detector and the atomic emission detector are the exceptions.

- Constant pressure— Maintains a constant gauge pressure at the head of the column throughout the run. If the column resistance and gas density changes during a run, the gauge pressure does not change but the mass flow rate does.
- Ramped pressure— Increases the column head gauge pressure during the run according to a program you enter. A column pressure profile can have up to three ramps, each consisting of a programmed increase followed by a hold period.

Nickel Catalyst Tube

About the nickel catalyst tube

The Nickel Catalyst Tube accessory, 3534A, is used for trace analysis of CO and CO₂ with a flame ionization detector. The gas sample is separated on the column and passed over a heated catalyst in the presence of hydrogen, which converts the CO and CO₂ peaks to CH₄.

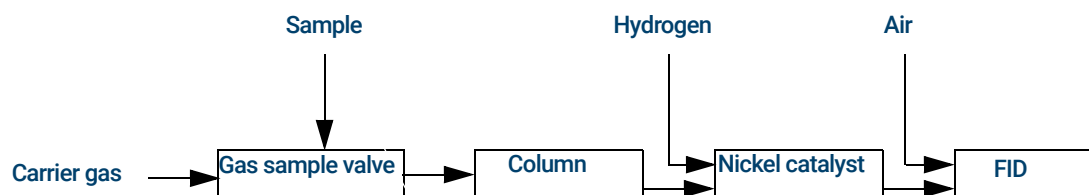

Detectors

For help creating a new method, or troubleshooting detector problems, see the recommended starting conditions for each detector.

The makeup gas line of your detector parameter list changes depending on your instrument configuration. If you have an inlet with the column not defined, the makeup flow is constant.

FID

FID automatic reignition (Lit offset)

Lit offset is the expected minimum difference between the FID output with the flame lit and the output with the flame off. The GC checks this value during runs and when loading a method.

During a run, if the output falls below the **Lit offset** value, the FID will attempt to reignite three times. If after the third attempt the output does not increase by at least this value, the detector shuts down all functions except temperature and makeup gas flow.

When loading a method that includes a **Flame On** setting, the GC performs a similar check. If the detector output is less than the **Lit offset**, it will attempt reignition after reaching method setpoints.

The default setting for **Lit offset** is 2.0 picoamps. This is a good working value for all but very clean gases and systems. You may want to lower this setpoint if the detector attempts to reignite when the flame is still on, thus producing a shutdown.

To change **Lit offset**:

- 1 Select **Settings**.
- 2 Select **Configuration**.
- 3 Select **Detectors**.
- 4 Select your FID from the detectors listed at the top of the window.
- 5 Enter the new value.

NOTE

The newly entered Lit offset is not applied/referenced against the detector output until the next ignition cycle.

Recommended starting conditions

See [Table 5](#) for guidelines and rules to select initial detector settings for new methods.

Table 5 Recommended starting conditions

Gas type	Suggested flow rate
Carrier gas (hydrogen, helium, nitrogen)	
Packed columns	10 to 60 mL/min
Capillary columns	1 to 5 mL/min

Table 5 Recommended starting conditions (continued)

Gas type	Suggested flow rate
Detector gases	
Hydrogen	40 mL/min*
Air	450 mL/min*
Column plus capillary makeup (N ₂ is recommended, or He as an alternative)	50 mL.min*
Detector Temperature	
If < 150 °C, the flame will not light. Agilent recommends a temperature ≥ 300 °C to prevent condensation damage. The detector temperature should be approximately 20 °C greater than highest oven ramp temperature.	

* The hydrogen / air ratio should be 8% to 12% to keep the flame lit

FPD+

The sample burns in a hydrogen- rich flame, where some species are reduced and excited. The gas flow moves the excited species to a cooler emission zone above the flame where they decay and emit light. A narrow bandpass filter selects light unique to one species, while a shield prevents intense carbon emission from reaching the photomultiplier tube (PMT).

The light strikes a photosensitive surface in the PMT where a light photon knocks loose an electron. The electron is amplified inside the PMT for an overall gain of up to a million.

Storage

The FPD+ should not be stored at temperatures above 50 °C.

FPD+ linearity

Several mechanisms produce sulfur emission. The excited species is diatomic, so that emission intensity is approximately proportional to the square of the sulfur atom concentration.

The excited species in the phosphorus mode is monatomic, leading to a linear relationship between emission intensity and atom concentration.

Inlet liners for use with the FPD+

Compounds containing sulfur may adsorb on an inlet liner and degrade the GC's performance. Use deactivated, clean liners or a cool on-column inlet, which injects directly onto the column.

For best results use Agilent Ultra Inert liners:

- Splitless 5190-2293
- Split 5190-2295

FPD+ temperature considerations

The FPD+ provides two temperatures zones, one for the transfer line (the main detector temperature) and one for the emission block. For the transfer line temperature, we recommend a temperature that is 25 °C higher than the highest column temperature.

The emission block temperature ranges from 125–175 °C. Typically, the default temperature of 150 °C is sufficient for most applications. However, when setting the emission block temperature, consider the following:

- If using the GC oven at high temperature (>325 °C) with the transfer line set to 400 °C, set the emission block temperature to 165 °C to avoid a system Not Ready if the emission block temperature cannot be maintained.
- If using the transfer line at 400 °C, set the emission block temperature to at least 150 °C to avoid a system Not Ready.
- For sulfur analyses, the highest area response will be realized with the lowest possible emission block temperature.
- For phosphorus analyses, the area response is independent of the emission block temperature.

Recommended starting conditions

The FPD+ provides two temperature zones, one for the transfer line (the main detector temperature) and one for the emission block. For the transfer line temperature, we recommend a temperature that is 25 °C higher than the highest column temperature. The emission block temperature ranges from 125–175 °C. Typically, the default temperature of 150 °C is sufficient for most applications.

Flows for the maximum sensitivity FPD+ flame, which is hydrogen-rich and oxygen-poor. Helium, either as carrier or makeup gas, may cool the detector gases below the ignition temperature.

Table 6 Recommended starting conditions

Gas type	Suggested flow rate
Carrier gas (hydrogen, helium, nitrogen)	
Packed columns	10 to 60 mL/min
Capillary columns	1 to 5 mL/min
Detector gases	
Hydrogen	60 mL/min
Air	60 mL/min
Column plus capillary makeup	60 mL.min

As with the FID, the FPD has a Lit Offset associated with it. The default Lit Offset for the FPD is 2.0 pA.

NPD

Setting NPD adjust offset on the clock table

You can use the **Clock table** feature to begin **Adjust offset** at a specified time.

Extending the NPD bead life

These actions, together with the automated heatup and adjust procedures, can extend bead life considerably.

- Use the lowest practical **Adjust Offset** value. This will result in a lower applied bead current during operation.
- Run clean samples.
- Turn the bead off when not in use.
- Keep the detector temperature high (320 to 335 °C).
- Turn the hydrogen flow off during solvent peaks and between runs.

Turning hydrogen off during a solvent peak When using the NPD, the baseline shifts after a solvent peak and can take some time to stabilize, especially with chlorinated solvents. To minimize this effect, turn off the hydrogen flow during the solvent peak and turn it back on after the solvent elutes. With this technique, the baseline recovers to its original value in less than 30 seconds. This also extends the life of the bead. The hydrogen can be turned on and off automatically as part of a Run Table. See **“Events”**.

Turning hydrogen off between runs To extend bead life, turn off the hydrogen flow between runs. Leave all other flows and the detector temperature on. Turn on the hydrogen flow for the next run; the bead will ignite almost immediately. The process can be automated with Run Table entries.

Recommended Starting conditions

Table 7 Recommended starting conditions

Gas type	Suggested flow rates
Carrier gas (helium, hydrogen, nitrogen [*])	Capillary: choose an optimal flow rate based on column dimensions.
Detector gases	
Hydrogen	1 to 3 mL/min
Air	60 mL/min
Makeup Flow (<i>He, N₂</i> [†])	1 to 20 mL/min, less is recommended
Bead voltage	
Bios bead.	
• Use Auto Adjust, Dry Bead , and let the GC set the applied bead current for you.	

* Flow rate must be less than 3 mL/min when using hydrogen as carrier gas.

† Helium is recommended for best peak shapes.

TCD

Chemically active compounds reduce TCD filament life

The tungsten-rhenium TCD filament has been chemically passivated to protect against oxygen damage. However, chemically active compounds such as acids and halogenated compounds may attack the filament. The immediate symptom is a permanent change in detector sensitivity due to a change in filament resistance.

If possible, such compounds should be avoided. If this is not possible, the TCD cell may have to be replaced frequently.

Changing the TCD polarity during a run

Negative polarity On inverts the peak so the integrator or Agilent data system can measure it. **Negative Polarity** can be a run table entry; see **“Events”**.

Detecting hydrogen with the TCD using helium carrier gas

Hydrogen is the only element with thermal conductivity greater than helium, and mixtures of small amounts of hydrogen (<20%) in helium at moderate temperatures exhibit thermal conductivities less than either component alone. If you are analyzing for hydrogen with helium carrier gas, a hydrogen peak may appear as positive, negative, or as a split peak.

There are two solutions to this problem:

- Use nitrogen or argon-methane as carrier gas. This eliminates problems inherent with using helium as carrier, but causes reduced sensitivity to components other than hydrogen.
- Operate the detector at higher temperatures—from 200 °C to 300 °C.

You can find the correct detector operating temperature by analyzing a known range of hydrogen concentrations, increasing the operating temperature until the hydrogen peak exhibits normal shape and is always in the same direction (negative relative to normal response to air or propane) regardless of concentration. This temperature also ensures high sensitivity and linear dynamic range.

Because hydrogen peaks are negative, you must turn negative polarity on at appropriate times so the peak appears positive.

Recommended Starting conditions

Table 8 Recommended starting conditions

Gas type	Suggested flowrates
Carrier gas (hydrogen, helium, nitrogen)	Packed: 10 to 60 mL/min Capillary: 1 to 5 mL/min
Reference (same gas type as carrier)	15 to 60 mL/min
Capillary makeup (same gas type as carrier)	Packed: 2 to 3 mL/min Capillary: 5 to 15 mL/min
Detector temperature	
<135 °C, cannot turn on filament	
If detector temperature goes below 125 °C, the filament turns off.	
Detector temperature should be 30 °C to 50 °C greater than the highest oven ramp temperature.	

ECD

ECD linearity

The ECD response factor versus concentration curve is linear for four orders of magnitude or more (linear dynamic range = 10^4 or higher) for a broad range of compounds. You should still run a calibration curve on your samples to find the limits of the linear range for your materials.

ECD makeup gas notes

If the carrier gas type is different from the makeup gas type, the makeup gas flow rate must be at least three times the carrier gas flow rate.

ECD sensitivity can be increased by reducing the makeup gas flow rate.

ECD chromatographic speed (for fast peaks) can be increased by increasing the makeup gas flow rate.

ECD temperature programming

The ECD is flow sensitive. If you are using temperature programming, in which the column flow resistance changes with temperature, set up the instrument as follows:

- Set the carrier gas in the **Constant flow** mode. Set detector makeup gas to **Constant makeup**.
- If you choose to work in the constant pressure mode, the makeup gas should be set in the **Column + makeup = constant** mode.

Recommended starting conditions for new ECD methods

Use the following information when selecting temperatures and flows. Maximum source pressure must not exceed 100 psi. Use the maximum source pressure to achieve maximum makeup flow rate.

Table 9 Recommended starting conditions

Gas type	Suggested flow rates
Carrier gas	
Packed columns (nitrogen or argon-methane)	30 to 60 mL/min
Capillary columns (hydrogen, nitrogen, or argon-methane)	0.1 to 20 mL/min, depending on diameter
Capillary makeup (nitrogen or argon-methane)	10 to 150 mL/min (30 to 60 mL/min typical)
Temperature	
250 °C to 400 °C	
Detector temperature is typically set 25 °C greater than the highest oven ramp temperature.	

Valves

The valve box

The GC holds up to four valves in a heated valve box on top of the oven.

The valve box is the preferred location for valves because it is a stable temperature zone, isolated from the column oven.

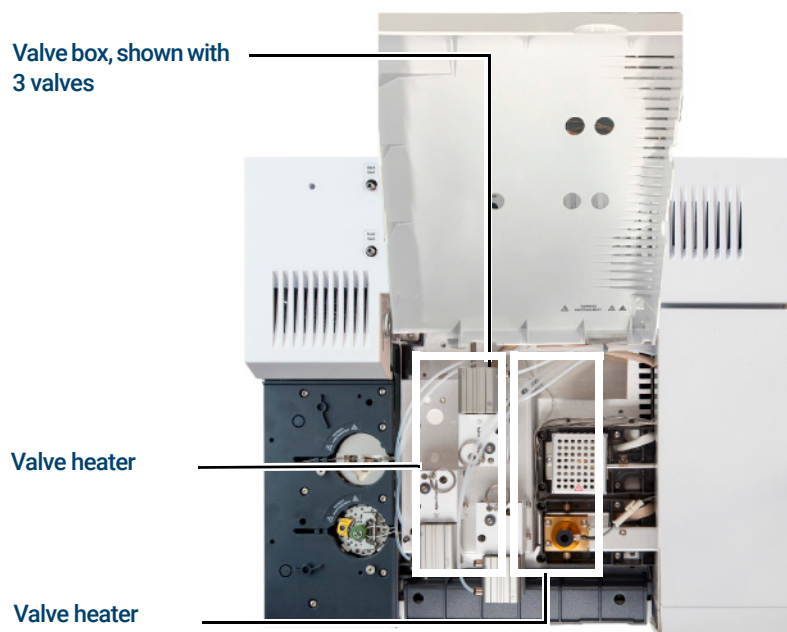

Figure 26. Diagram of valve locations on GC

Valves may also be mounted inside the column oven.

Valve control

Valves can be controlled manually from the touchscreen, Browser Interface, or as part of a clock or run time program. Note that only sampling valves automatically reset at the end of a run. Other valve types remain at the new position until activated again. For other valve types, you must include any desired resets in the program.

The valve drivers

A valve driver is the software and circuitry in the GC that controls a valve or related function. There are eight drivers known as Valve 1 through Valve 8.

Table 10 Valve drivers

Valve number	Type	Volts	Power or current	Use
1, 2, 3, 4, 9, and 10	Current source	24 VDC	13 watts	Pneumatic valve control
5 and 6	Current source	24 VDC	100 mA	Relays and low-power devices
7 and 8	Contact closure	48 VDC or 48 VAC RMS		Control an external current source

The internal valve drivers

Valve drivers 1 through 4, 9, and 10 are usually used to control pneumatically operated valves mounted in the valve box. The wiring for these appears at a set of connectors inside the right cover of the GC.

Pneumatically driven valves are controlled by solenoids mounted near the connectors that control the flow of air to the valve actuators.

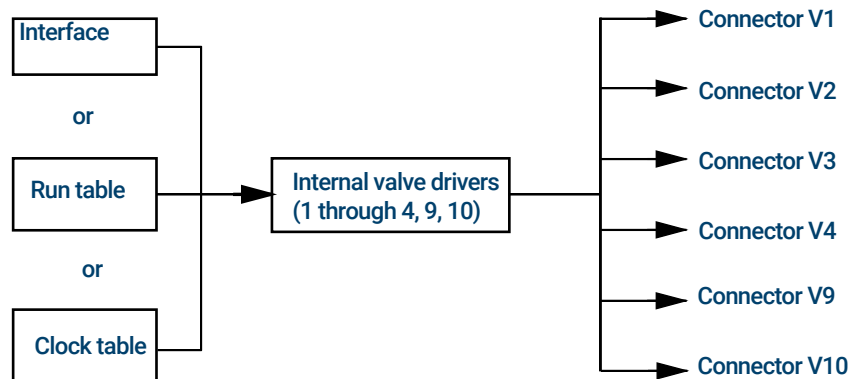

There is no direct relationship between the location of a valve in the valve box and the driver that controls it. This depends on how the solenoids are wired and the actuators are plumbed.

Manual valves must be switched by hand, and are heated or unheated.

The external valve drivers

Valve drivers 5 and 6 control a current that may be used to drive a relay or other low-power device. Valve drivers 7 and 8 switch a current from an external source. Electrical details are in **Table 10**.

These drivers, particularly Valve 7 and 8, may be used to control a motor driven multiposition valve for stream selection.

All four of these drivers appear on the External Event connector on the back of the GC.

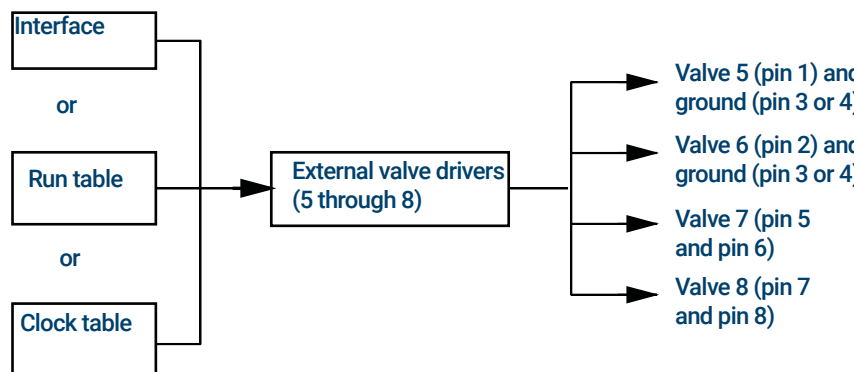

Valve types

The possible valve types are:

Sampling A two-position (load and inject) valve. In load position, an external sample stream flows through an attached (gas sampling) or internal (liquid sampling) loop and out to waste. In inject position, the filled sampling loop is inserted into the carrier gas stream. When the valve switches from **Load** to **Inject**, it starts a run if one is not already in progress. See the example on [page 98](#).

Switching A two-position valve with four, six, or more ports. These are general-purpose valves used for such tasks as column selection, column isolation, and many others. For an example of valve control, see [page 99](#).

Multiposition Also called a stream selection valve. It is usually used to select one from a number of gas streams and feed it to a sampling valve for analysis. It has a special actuator that advances the valve one position each time it is activated, or it may be motor driven. An example that combines a stream selection valve with a gas sampling valve is on [page 99](#).

Other Could be anything.

Not installed There is no valve installed in this position.

Controlling a valve

From the run or clock time tables

The **Valve On** and **Valve Off** commands can be run time or clock time programmed. See [“Events”](#) and [“Clock Time Programming”](#).

If a valve is rotated by a run time program, it is not automatically returned to its initial position at the end of the run. You must program this reset operation yourself.

Switching valve: column selection

This is the plumbing for a single valve, configured as a switching valve, that selects one of two columns for analysis. It has no configuration parameters.

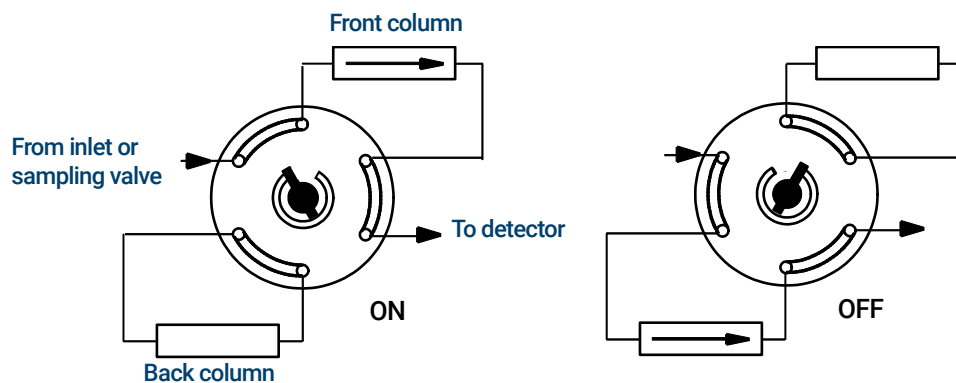

When the valve is set to **On**, the front column is selected. When the valve is set to **Off**, the back column is selected

Use a run table entry to ensure that the valve is in the Off state between runs.

Sampling valve

If a valve is configured as a sampling valve, it starts a run automatically when it is switched to the Inject position. This can be done by a subsequence or clock table entry. You may have two gas sampling valves installed.

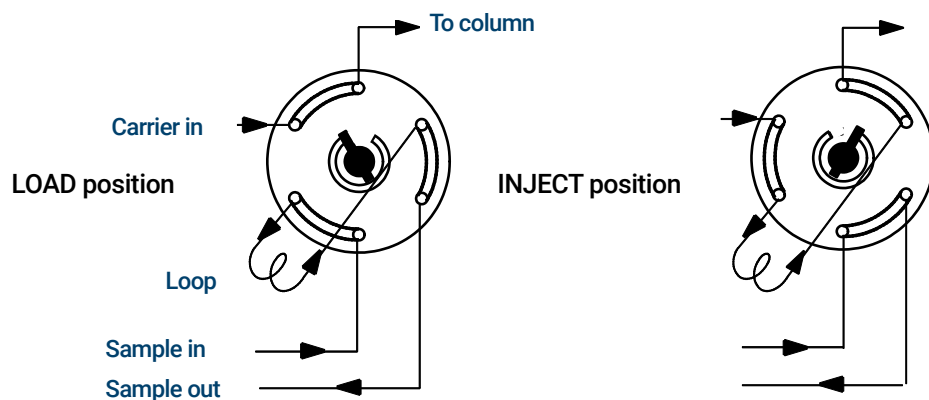

Sampling valves have two positions:

Load position The loop (external for gas sampling, internal for liquid sampling) is flushed with a stream of the sample gas. The column is flushed with carrier gas.

Inject position The filled loop is inserted into the carrier gas stream. The sample is flushed onto the column. The run starts automatically.

Carrier gas may be provided by an (optional) auxiliary gas channel. To do this, configure the column and specify an Aux # channel as the inlet. The channel then becomes programmable with four operating modes.

The gas sampling valve control parameters are:

Load time Time in minutes that the valve remains in the Load position before becoming ready.

Inject time Time in minutes that the valve remains in the Inject position before returning to the Load position.

The sampling valve cycle is:

- 1 The sampling valve rotates to the Load position. **Load time** begins. Valve is not ready.
- 2 **Load time** ends. The valve becomes ready.
- 3 If everything else is ready, the GC becomes ready. If anything is not ready:
 - If you are using Clock Table or sequence control, the GC waits until everything is ready, then executes the valve inject command.
 - If you are not using Clock Table or sequence control, the valve injection can be made at any time from the keyboard.
- 4 The sampling valve rotates (keyboard command or sequence control) to the Inject position. **Inject time** begins. The run begins.
- 5 **Inject time** ends. Return to step 1.

Multiposition stream selection valve with sampling valve

Several manufacturers provide multiposition stream selection valves that can be driven by valve drivers 7 or 8. Only one multiposition valve can be configured.

If a valve is configured as a multiposition valve and has a BCD position output connected to the GC, the valve position can be selected directly.

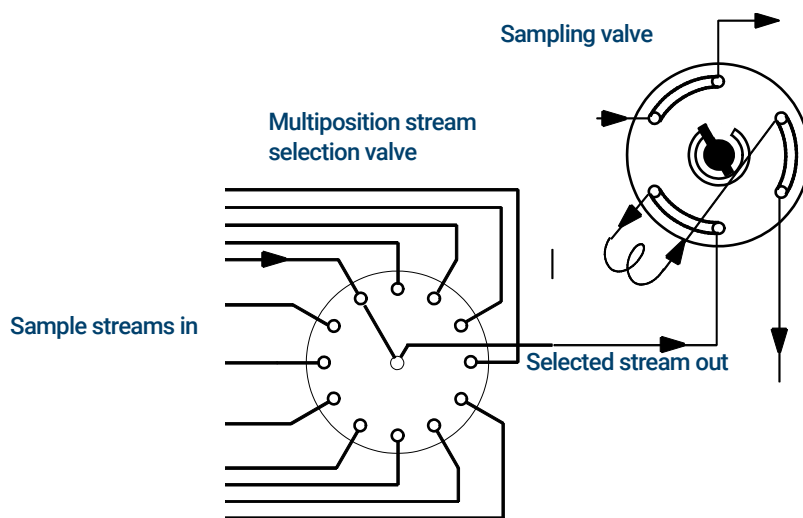

If the GC has one valve configured as a multiposition valve and another configured as a gas or liquid sampling valve, it assumes that they are to be used in series. This “double configuration” can be used to replace an automatic liquid sampler and sample tray in an analytical sequence. The multiposition valve becomes the sample tray; the sampling valve becomes the injector.

Two configuration parameters provide mechanical and electrical compatibility with most multiposition valve actuators.

Step time In seconds, is a delay between successive actuator movements. It allows time for the actuator mechanism to prepare for the next movement.

BCD Inverted Complements the BCD input; 1's become 0's and 0's become 1's. This accommodates coding convention differences among manufacturers.

GC Output Signals

Signal is the GC output to a data handling device, analog or digital. It can be a detector output or the output from flow, temperature, or pressure sensors. Two signal output channels are provided.

Signal output can be either analog or digital, depending on your data handling device. Analog output is available at either of two speeds, suitable to peaks with minimum widths of 0.004 minutes (fast data rate) or 0.01 minutes (normal rate). Analog output ranges are 0 to 1 V, 0 to 10 V.

Digital output rates are set by your Agilent data system, such as OpenLAB CDS or MassHunter Workstation.

See **Table 11** for the conversions from units shown on the GC display to units as shown in Agilent data systems and integrators.

Table 11 Signal conversions

Signal type	1 display unit is equivalent to:
Detector:	
FID, NPD	1.0 pA (1.0×10^{-12} A)
FPD+	150 pA (150×10^{-12} A)
TCD	25 μ V (2.5×10^{-5} V)
ECD	1 Hz
Analog input board (use to connect the GC to non-Agilent detector)	15 μ V
Nondetector:	
Thermal	1 °C
Pneumatic:	
Flow	1 mL/min
Pressure	1 pressure unit (psi, bar, or kPa)
Diagnostic	Mixed, some unscaled

When outputting a column pressure signal, the GC reports the pressure in absolute units. For example, an inlet pressure of 68.9 kPa would be reported as 170.2 kPa.

Analog signals

If you use an analog recorder, you may need to adjust the signal to make it more usable. **Zero** and **Range** in the Signal parameter list do this.

Analog zero

Zero Subtracts value entered from baseline. Either select **On** to set Zero at the current signal value, or enter a number between -500,000 and +500,000 as the setpoint to subtract from the baseline.

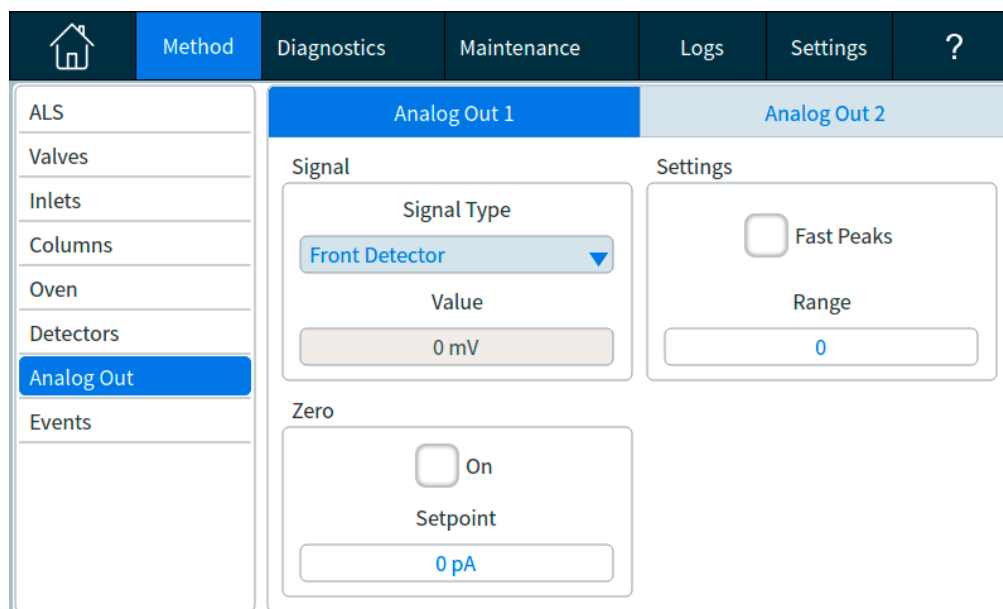

This is used to correct baseline elevation or offsets. A common application is to correct a baseline shift that occurs as the result of a valve operation. After zeroing, the analog output signal is equal to the **Value** line of the parameter list minus the **Zero** setpoint.

Zero can be programmed as a run time event. For details, see [“Events”](#).

Analog range

Range Scales data coming from the detector

Range is also referred to as gain, scaling, or sizing. It sizes the data coming from the detector to the analog signal circuits to avoid overloading the circuits (clamping). **Range** scales all analog signals.

If a chromatogram looks like A or B in the next figure, the data needs to be scaled (as in C) so that all peaks are visible on the paper.

Valid setpoints are from 0 to 13 and represent 2^0 (=1) to 2^{13} (=8192). Changing a setpoint by 1 changes the height of the chromatogram by a factor of 2. The following chromatograms illustrate this. Use the smallest possible value to minimize integration error.

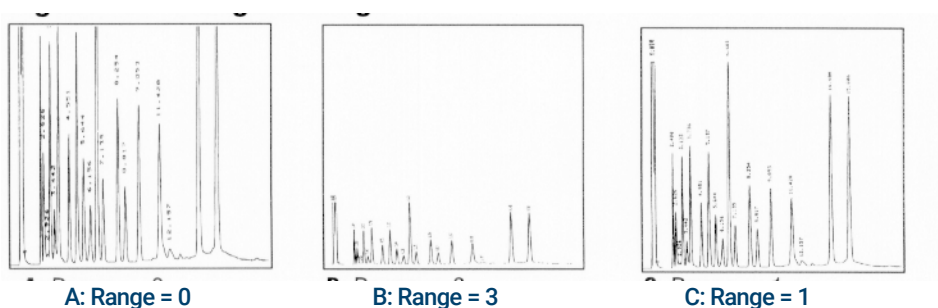

There are limits to usable range settings for some detectors. The table lists the valid range setpoints by detector.

Table 12 Range limits

Detector	Usable range settings (2x)
FID	0 to 13
NPD	0 to 13
FPD+	0 to 13
TCD	0 to 6
ECD	0 to 6
Analog input	0 to 7

Range may be run time programmed. See “**Events**” for details.

Analog data rates

Your integrator or recorder must be fast enough to process data coming from the GC. If it cannot keep up with the GC, the data may be damaged. This usually shows up as broadened peaks and loss of resolution.

Speed is measured in terms of bandwidth. Your recorder or integrator should have a bandwidth twice that of the signal you are measuring.

The GC allows you to operate at two speeds. The faster speed allows minimum peak widths of 0.004 minutes (8 Hz bandwidth), while the standard speed allows minimum peak widths of 0.01 minutes (1.6 Hz bandwidth).

If you use the fast peaks feature, your integrator should operate at around 15 Hz.

Selecting fast peaks (analog output)

- 1 Select **Settings > Configuration**.
- 2 Select Analog Out.
- 3 Select the checkbox next to Fast Peaks.

Agilent does not recommend using **Fast peaks** with a thermal conductivity detector. Since the gas streams switch at 5 Hz, the gain in peak width is offset by increased noise.

Digital signals

The GC outputs digital signals only to an Agilent data system. The following discussions describe features that impact the data sent to data systems, not the analog data available to integrators. Access these features from the data system. These features are not accessible from the GC touchscreen or Browser Interface.

Zero signal

Available only from an Agilent data system.

Digital signal outputs respond to a zero command by subtracting the signal level at the time of the command from all future values.

Signal Freeze and Resume

Available only from an Agilent data system.

Some run time operations, such as changing signal assignments or switching a valve, can cause baseline upsets. Other factors can cause baseline upsets also. The GC can compensate for this by pausing (freezing) the signal at a particular value, using that signal value for a specified duration, and then resuming normal signal output.

Consider a system that uses a switching valve. When the valve switches, an anomaly occurs in the baseline. By freezing and resuming the signal, the anomaly can be removed so that the peak identification and integration software operates more smoothly.

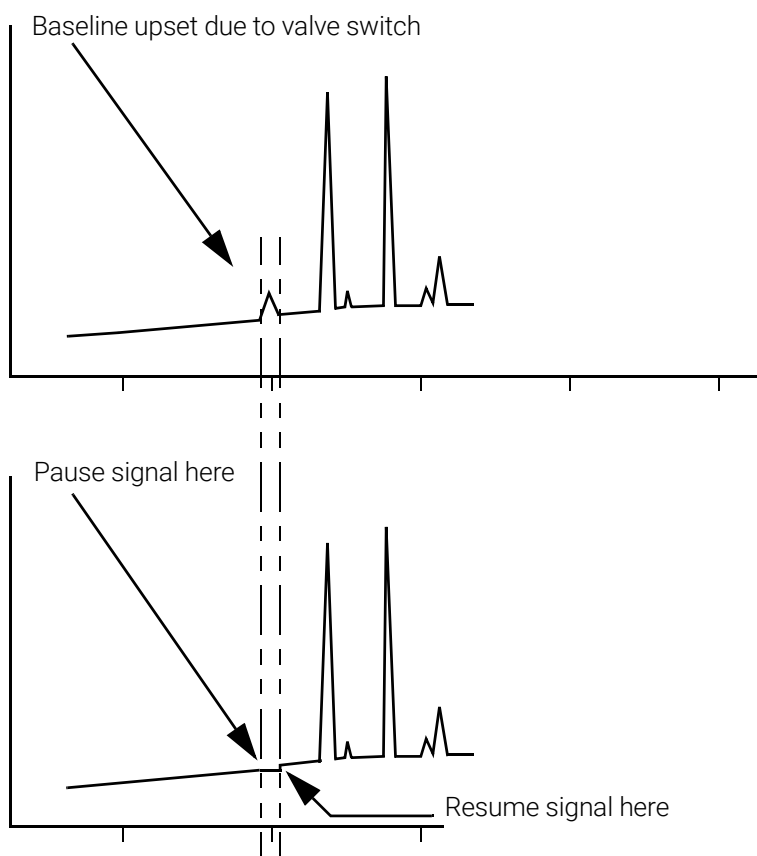

Data rates with Agilent data systems

The GC can process data at various data rates, each corresponding to a minimum peak width. The table shows the effect of data rate selection.

Table 13 Agilent data system data processing

Data rate, Hz	Minimum peak width, minutes	Relative noise	Detector	Column type
1000	0.0002	6.96	FID/NPD	Narrow-bore, 0.05 mm
500	0.0004	5	FID/NPD	Narrow-bore, 0.05 mm
200	0.001	3.1	FID/FPD+/NPD	Narrow-bore, 0.05 mm
100	0.002	2.2	FID/FPD+/NPD	Capillary
50	0.004	1.6	ECD/FID/FPD+/NPD	↓ to
20	0.01	1	ECD/FID/FPD+/NPD	
10	0.02	0.7	ECD/FID/FPD+/NPD	
5	0.04	0.5	ECD/FID/FPD+/NPD /TCD	
2	0.1	0.3	ECD	
1	0.2	0.22	ECD	↓ Slow packed
0.5	0.4	0.16	ECD	
0.2	1.0	0.10	ECD	
0.1	2.0	0.07	ECD	

You cannot change the data rate during a run.

You will see higher relative noise at the faster sampling rates. Doubling the data rate can double peak height while the relative noise increases by 40%. Although noise increases, the signal-to-noise ratio is better at the faster rates.

This benefit only occurs if the original rate was too low, leading to peak broadening and reduced resolution. We suggest that rates be chosen so that the product of data rate and peak width in seconds is about 10 to 20.

The figure shows the relationship between relative noise and data rates. Noise decreases as the data rate decreases until you get to data rates of around 5 Hz. As the sampling rate slows, other factors such as thermal noise increase noise levels.

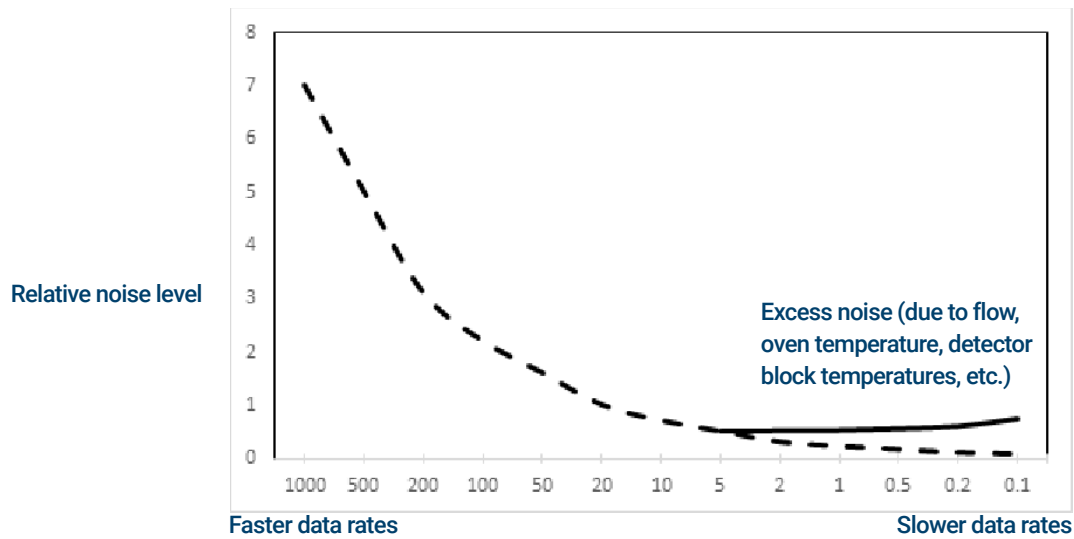

Column compensation

In temperature programmed analysis, bleed from the column increases as the oven temperature rises. This causes a rising baseline which makes peak detection and integration more difficult. Column compensation corrects for this baseline rise.

A column compensation run is made with no sample injected. The GC collects an array of data points from all 4 detectors, whether installed, off, or working. If a detector is not installed or is turned off, that part of the array is filled with zeros.

Each array defines a set of curves, one for each detector, that can be subtracted from the *real* run to produce a flat baseline. The next figure illustrates the concept.

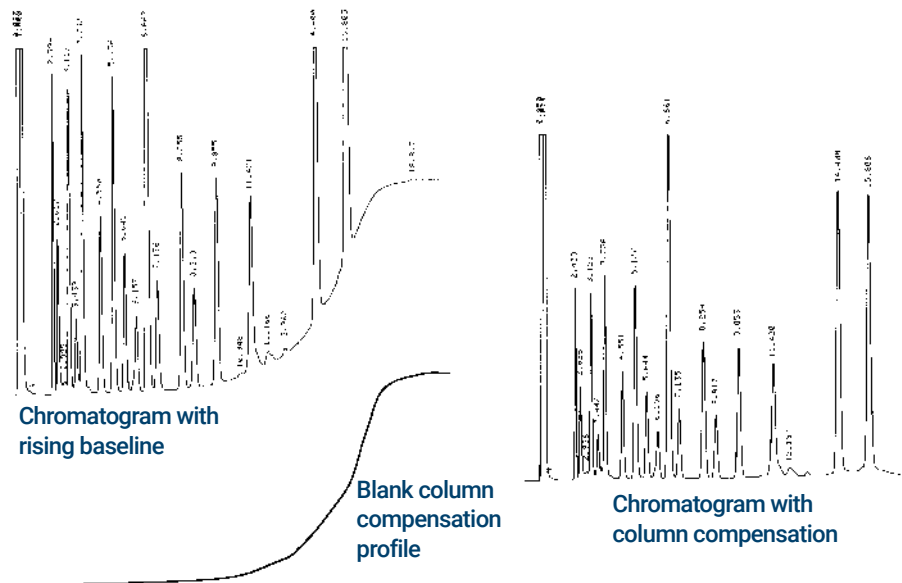

All conditions must be identical in the column compensation run and the *real* run. The same detector and column must be used, operating under the same temperature and gas flow conditions.

Test plot

Test plot is an internally generated “chromatogram” that can be assigned to a signal output channel. It consists of three baseline-resolved, repeating peaks. The area of the largest is approximately 1 Volt-sec, the middle one is 0.1 times the largest, and the smallest is 0.01 times the largest.

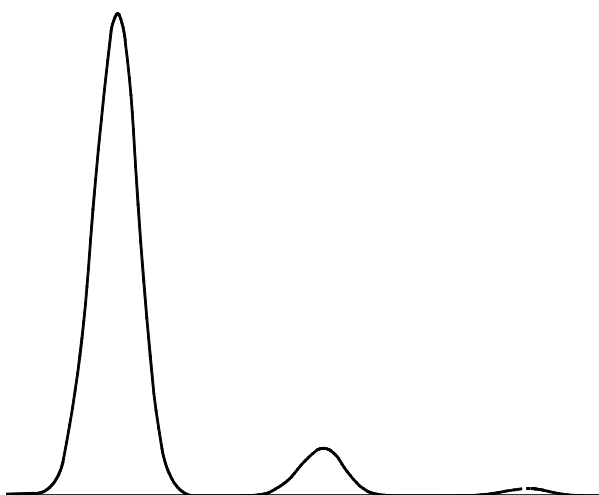

Test plot can be used to verify the operation of external data processing devices without having to perform repeated chromatographic runs. It may also be used as a stable signal to compare the results from different data processing devices.

To use the Test Plot:

- 1 Select **Method > Analog Out**.
- 2 Select the dropdown under Signal Type.
- 3 Select **Test Plot**.

Test Plot is the default choice for the analog outputs. Test Plot can also be selected as a digital signal when using the Browser Interface or a data system.

6

Sequences

What is a Sequence? 110

Recoverable Errors 111

What is a Sequence?

A sequence is a list of samples to be analyzed along with the method to be used for each analysis. Sequences can be set up from the Browser Interface, or from the connected Agilent data system. Refer to the help provided in the Browser Interface or data system for details.

Recoverable Errors

For details on how this feature works in your data system, refer to its help and documentation.

Some types of errors, such as an ALS missing vial error or a headspace sampler vial size mismatch, may not always justify stopping an entire sequence. These errors are called *recoverable errors*, since you may be able to recover from them and continue running a sequence, if desired. Agilent data systems now provide features to allow you to control how the system will react to these types of errors. When using an Agilent data system, the data system will now control whether or not the sequence pauses, aborts completely, continues with the next sample, and so on, for each type of recoverable error.

Note that the data system only controls what happens to the *next* run in the sequence, not the *current* run, except when set to immediately abort. (In that case, the data system typically aborts the current run and the sequence.)

For example, selecting the **Stop** control  on the GC always halts the current run. However, the data systems can allow you to choose whether to continue with the next run or to pause or to abort the whole sequence.

Diagnostics

About Diagnostics	114
The system health report	114
Automated testing	115
Self-guided diagnostics	115
Using the Diagnostics View	117
Performing Diagnostic Tests	118

About Diagnostics

The GC provides diagnostics features for inlets, detectors, and other installed components. This includes tests that are performed by the operator and automated testing that is performed by the GC without operator intervention.

The Diagnostics view provides access to the system health report and operator initiated diagnostic tests.

Additionally, the view provides a list of all current alerts. When a condition arises, the GC lists the problem in Diagnostics. Select a condition to see a description of the issue and recommended diagnostic tasks that might help resolve it. If a listed diagnostic task is automated, select it to run it. See **Figure 27**.

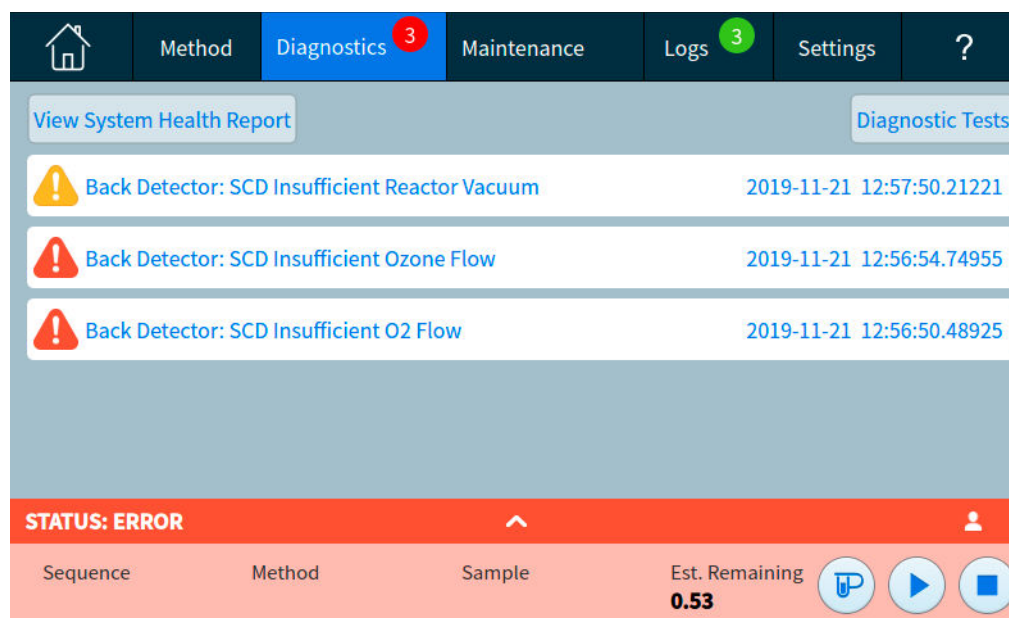

Figure 27. Diagnostics view

The system health report

To access the system health report, select **View System Health Report**. The system health report appears.

The system health report includes the following types of information:

- System information
- System Configuration details
- Active instrument conditions
- Column details
- Early Maintenance Feedback details
- Diagnostic test results
- Network information
- Status snapshot information

Automated testing

The GC performs continuous, automated testing of the following items. If a failure occurs, an alert appears on the diagnostic tab. See **Figure 27**. In addition, an entry is made in the appropriate log.

See below for a list of the continuous monitoring dialogs:

Detector:

- Supply voltage
- ADC (analog to digital converter) references
- FID flameout
- NPD bead open/short
- Igniter open/short
- Collector short
- Electrometer not plugged in
- TCD filament open or short
- TCD switching valve open or short
- FPD flameout

EPC (Electronic Pneumatic Control) - Inlets, detectors, and other modules.

ADC (analog to digital converter) references

Actuator movements

Thermal:

- Sensor open/short
- Missing heater
- Wrong heater
- Heater current:
 - Quiescent
 - Leakage

Configuration Mismatch

Self-guided diagnostics

The GC offers several useful diagnostic checks to use when troubleshooting issues with the GC or method. See below for a list of self-guided diagnostic tests available:

Inlet tests:

- Leak & Restriction test
- Gas Supply Pressure test
- Split Vent Restriction test
- Pressure Decay test
- Septum Purge test

7 Diagnostics

Detector tests:

- FID Jet Restriction test
- FID Leakage Current test

Using the Diagnostics View

To use the Diagnostics view:

- 1 Select **Diagnostics**. The Diagnostics view appears. The view provides a list of all current alerts.
- 2 Select **Diagnostic Tests**. The Diagnostic Tests page appears. See **Figure 28**.

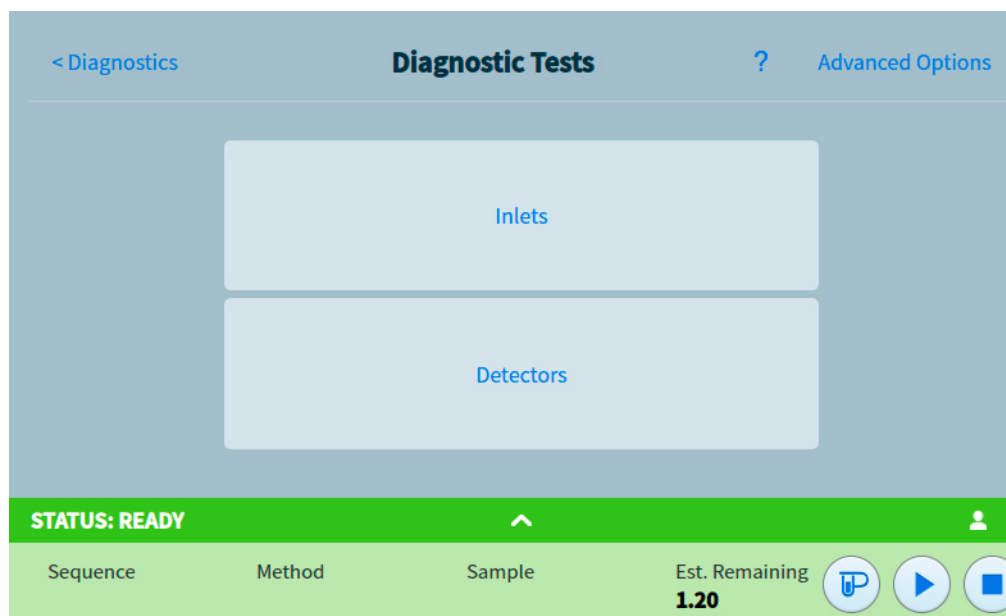

Figure 28. Diagnostic Tests page

- 3 Select **Inlets**, **Detectors**, or **Other**, as desired. The corresponding page will appear. For example, selecting **Inlets** brings up the Inlet Diagnostic Tests page. See **Figure 29**.

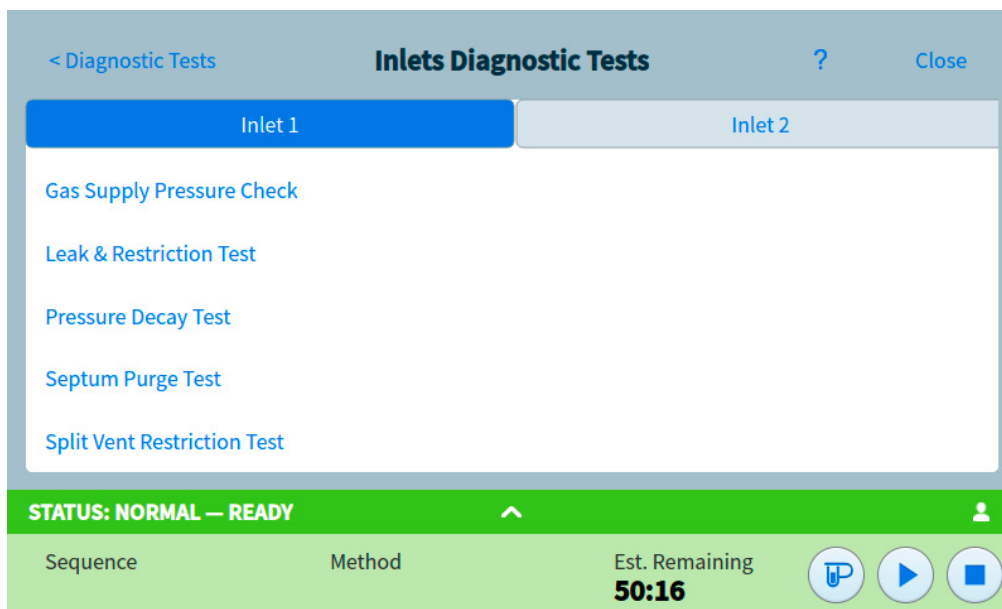

Figure 29. Inlet Diagnostic Tests page

Performing Diagnostic Tests

To perform a diagnostic test:

- 1 Access the desired test from the Diagnostics view. See **“Using the Diagnostics View”**.
- 2 Select the desired test. The corresponding test page appears. The test page includes a test description and an indication of the parameter being tested. See **Figure 30**.

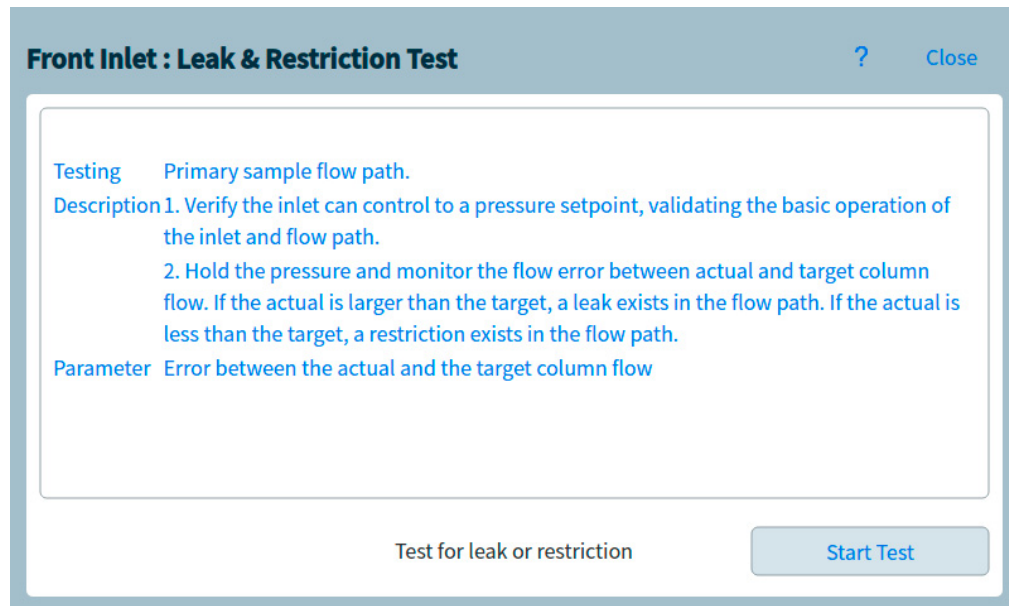

Figure 30. Leak & Restriction Test page

- 3 Select **Start Test**. Testing is initiated. Test details are displayed along with test results. See **Figure 31**.

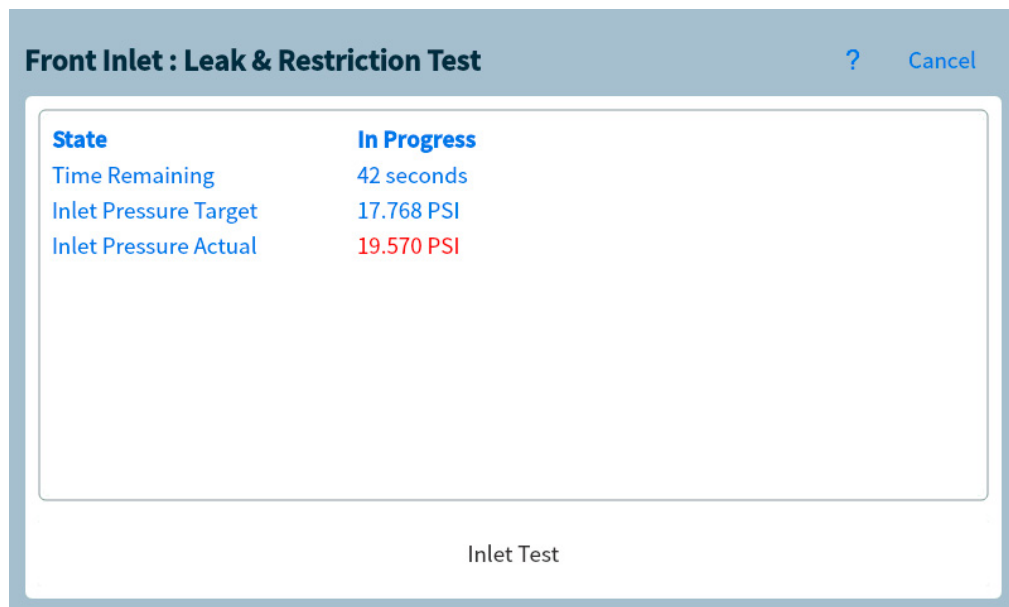

Figure 31. Leak & Restriction Test page

The currently running test can be aborted by selecting **Cancel**. This brings up a dialog box which allows you to confirm that you want to cancel the test. See **Figure 32**.

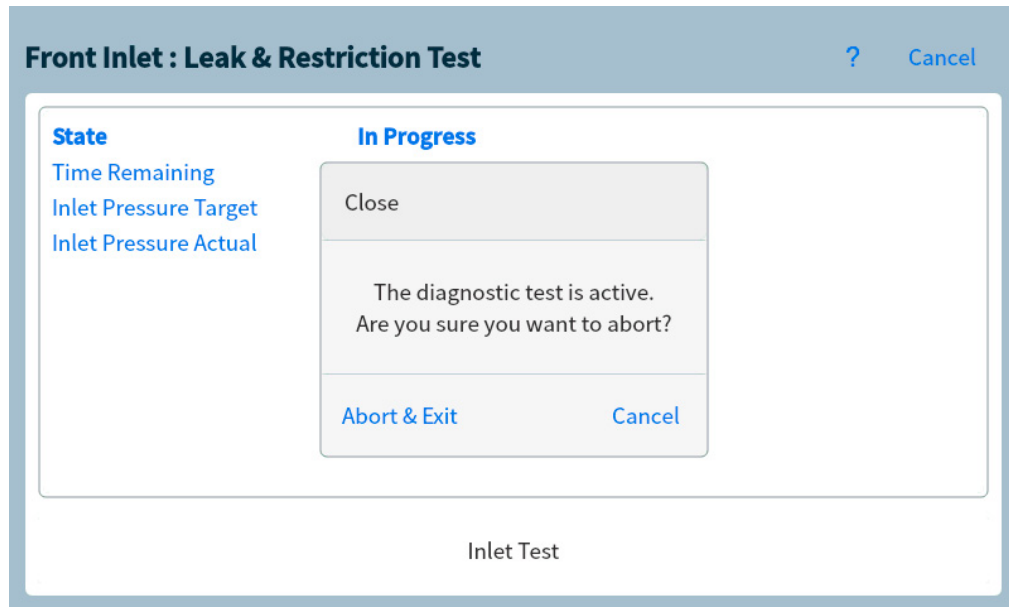

Figure 32. Abort dialog box

Early Maintenance Feedback (EMF)	122
Counter types	122
Thresholds	122
Default Thresholds	123
Perform Maintenance	124
Available Counters	125
Viewing Maintenance Counters	128
To Enable, Reset, or Change a Limit for an EMF Counter	129
EMF Counters for Autosamplers	130
Counters for 7693A and 7650 ALS with EMF-enabled firmware	130
Counters for ALS with earlier firmware	130
EMF Counters for MS Instruments	131

Selecting the maintenance navigation tab shows buttons for counters by component, lets you view the maintenance log, and lets you start automated, step-by-step maintenance procedures for various components. These procedures also include automated tests as needed to help be sure the GC is ready when maintenance is complete. See the *8890 Maintaining Your GC manual* for more information.

Early Maintenance Feedback (EMF)

The 8890 provides injection- and time-based counters for various consumable and maintenance parts. Use these counters to track usage and replace or recondition these items before potential degradation impacts the chromatographic results.

If using an Agilent data system, these counters can be set and reset from within the data system.

Counter types

Counters are provided for injections, runs, and time. Each type is described below.

Injection counters increment whenever an injection occurs on the GC via an ALS injector, headspace sampler, or sampling valve. Manual injections do not increment counters. The GC differentiates between front and back injections, and only increments counters associated with the configured injection flow path.

For example, consider the following GC:

Configured front flow path	Configured back flow path
Front injector	Back injector
Front inlet	Back inlet
Column 1 (GC oven)	Column 2 (GC oven)
Purged Union / Aux EPC 1	Back detector
Column 3 (GC oven)	
Front detector	

In this example, for a front ALS injection, the GC will increment counters for the front injector, front inlet, and the front detector, but it would not increment the back injector, back inlet, or back detector counters. For the columns, the GC would increment the injection counters for columns 1 and 3, and the oven cycles counter for all 3 columns.

Run counters increment against the number of runs performed on the GC.

Time counters increment against the GC clock. Changing the GC clock changes the age of tracked consumables.

Thresholds

The EMF feature provides two warning thresholds: **Service Due** and **Service Warning**. When either threshold is passed, an indication appears on the **Maintenance** tab on the GC touchscreen ribbon.

Selecting the **Maintenance** tab brings up the Maintenance view. See [Figure 33](#).

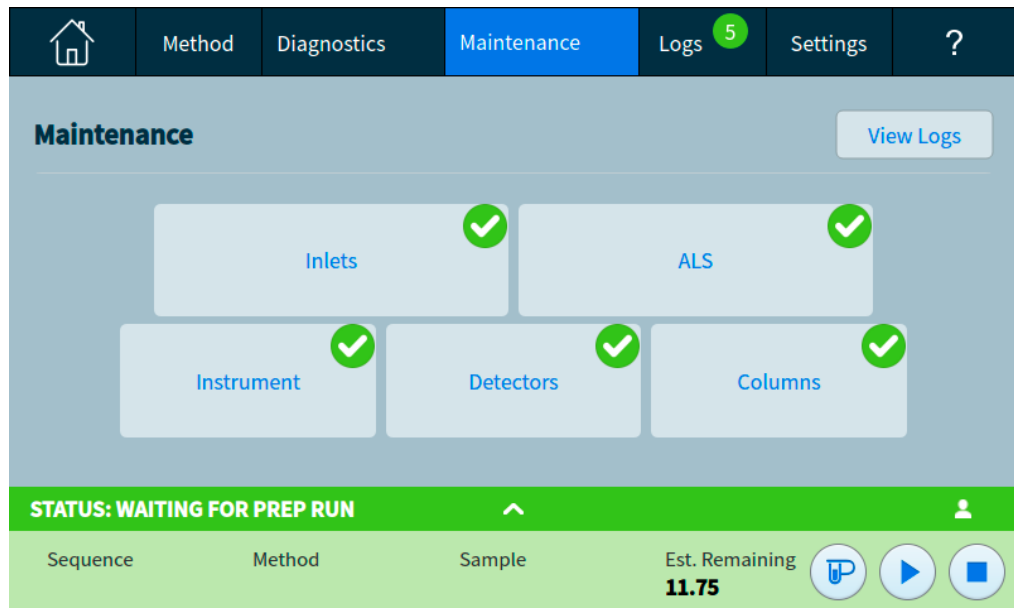

Figure 33. Maintenance view

Selections are available for any installed component.

Two thresholds are settable for any given item:

- **Service Due:** When the counter exceeds this number of injections, runs, or days, a red warning icon appears on the corresponding button, and an entry is made in the **Maintenance Log**.
- **Service Warning:** When the counter exceeds this number of injections or days, an orange warning icon appears on the corresponding button, indicating that the component needs maintenance soon.

Both thresholds are set independently for each counter. You can enable one or both, as desired. The **Service Due** limit must be larger than the **Service Warning** limit.

Default Thresholds

Selected counters have default thresholds to use as a starting point.

If you want to change a default limit, enter a conservative limit based on your experience. Use the warning feature to alert you when service is approaching, then track performance to determine if the **Service Due** threshold is too high or too low.

For any EMF counter, you may need to adjust the threshold values based on the demands of your applications.

Perform Maintenance

For many common maintenance procedures, your GC contains a detailed walkthrough of each procedure. These procedures may be accessed by selecting **Maintenance** > your desired component > **Perform Maintenance**. Once here, select your desired maintenance procedure, and select **Start Maintenance** to begin the walkthrough.

< Overview **Instrument Maintenance** ?

Cool down option for performing instrument maintenance

Provide Inputs:

Maintenance Mode Gas Clean Filter Maintenance

Start Maintenance

Many maintenance procedures require you to put the GC in maintenance mode prior to performing any maintenance. To do so, select **Maintenance** > **Instrument** > **Perform Maintenance**, select the checkbox next to Maintenance Mode, and then select **Start Maintenance**. Putting the GC into maintenance mode can additionally include:

- Setting low temperatures to avoid burns and other injuries
- Setting reduced flows to avoid safety hazards and to prevent damage to the instrument
- Venting a mass selective detector (MSD)
- Making other settings to prevent damage to the instrument (electronics, columns, and so forth) or to connected instruments (MSD)

For example, to change the gas clean filter, select **Maintenance** > **Instrument** > **Perform Maintenance**, select the checkbox next to Gas Clean Filter Maintenance, and then select **Start Maintenance**. This cools down the required components of the GC, and then walks you through the procedure for replacing the gas clean filter.

Available Counters

Table 14 lists the most common counters available. The available counters will vary based on the installed GC options, consumables, and future updates.

Table 14 Common EMF counters

GC Component	Parts with a counter	Type	Default value
Detectors			
FID	Collector	Number of injections	
	Jet	Number of injections	
	Ignitor	Number of ignition attempts	
TCD	Switching solenoid	On time	
	Filament on time	On time	
ECD	Insert liner	Number of injections	
	Time since wipe test	On time	6 months
NPD	Bead	Number of injections	
	Collector	Number of injections	
	Bead baseline offset	pA Value	
	Bead baseline voltage	Voltage value	Blos bead: 1.045
	Bead current integral	pA-sec Value	
FPD+	Ignitor	Number of ignition attempts	
	PMT	Number of injections	
	PMT	On time	6 months
Inlets			
SSL	Gold seal	Number of injections	5000
	Gold seal	Time	90 days
	Liner	Number of injections	200
	Liner	Time	30 days
	Liner O-ring	Number of injections	1000
	Liner O-ring	Time	60 days
	Septum	Number of injections	200
	Split vent trap	Number of injections	10,000
	Split vent trap	Time	6 months
MMI	Liner	Number of injections	200
	Liner	Time	30 days

Table 14 Common EMF counters (continued)

GC Component	Parts with a counter	Type	Default value
	Liner O-ring	Number of injections	1000
	Liner O-ring	Time	60 days
	Septum	Number of injections	200
	Split vent trap	Number of injections	10,000
	Split vent trap	Time	6 months
	Cooling cycles	Number of injections	
	Clean bottom seal	Number of injections	1000
PP	Liner	Number of injections	200
	Liner	Time	30 days
	Septum	Number of injections	200
	Top weldment O-ring	Number of injections	10,000
	Top weldment O-ring	Time	1 year
COC	Septum	Number of injections	200
PTV	Column adapter silver seal	Number of injections	5000
	Liner	Number of injections	200
	Liner	Time	30 days
	Split vent trap	Number of injections	10,000
	Split vent trap	Time	6 months
	PTFE ferrule	Number of injections	
	PTFE ferrule	Time	60 days
VI	Split vent trap	Number of injections	10,000
	Split vent trap	Time	6 months
Columns			
Column	Injections onto column	Number of injections	
	Oven cycles	Number of injections	
	Length	Value	
	Run count	Number of runs	
Valves			
Valve	Rotor	Activations (number of injections)	
	Maximum temperature	Value	
Instrument			

Table 14 Common EMF counters (continued)

GC Component	Parts with a counter	Type	Default value
Instrument	On time	Time	
	Run count	Number of runs	
	Filters	Time	
ALS Injectors			
ALS	Syringe	Number of injections	800
	Syringe	Time	2 months
	Needle	Number of injections	800
	Plunger moves	Value	6000
Mass spectrometers			
Mass spectrometer	Pump	Time (days)	1 year
	Filament 1	Time (days)	1 year
	Filament 2	Time (days)	1 year
	Source (time since last cleaning)	Time (days)	1 year
	EMV at last tune	V	2600

Viewing Maintenance Counters

To view the maintenance counters:

- 1 Select the **Maintenance** tab. See **Figure 33**.
- 2 Select the desired component type. The Status column lists the counter for the corresponding component. See **Figure 34**.

The screenshot shows the 'ALS Maintenance' interface. At the top, there are navigation options: '< Overview', 'ALS Maintenance', and '? Perform Maintenance'. Below this is a tabbed interface with 'Front ALS' selected and 'Back ALS' visible. A table lists maintenance items with their status and counter values. A green bar at the bottom indicates 'STATUS: READY' with an upward arrow and a user icon. Below the status bar is a control bar with columns for 'Sequence', 'Method', 'Sample', and 'Est. Remaining' (showing '1.20'). There are also three circular icons: a document with a checkmark, a play button, and a square stop button.

Part	Status	Reset All
✓ Needle injections	384 injections	
✓ Plunger moves	2652 cycles	
✓ Syringe age	51 wk 5 days 21 hrs	
✓ Syringe injections	384 injections	

STATUS: READY ^

Sequence Method Sample Est. Remaining **1.20** [Document] [Play] [Stop]

Figure 34. Detector Maintenance page

- 3 Scroll to view additional components, as applicable.

To Enable, Reset, or Change a Limit for an EMF Counter

When using the GC without a data system, enable or change the limit for a counter as follows:

- 1 Locate the counter you wish to change. See **“Viewing Maintenance Counters”**.
- 2 Select the Component listing for the counter you want to change. See **Figure 35**.

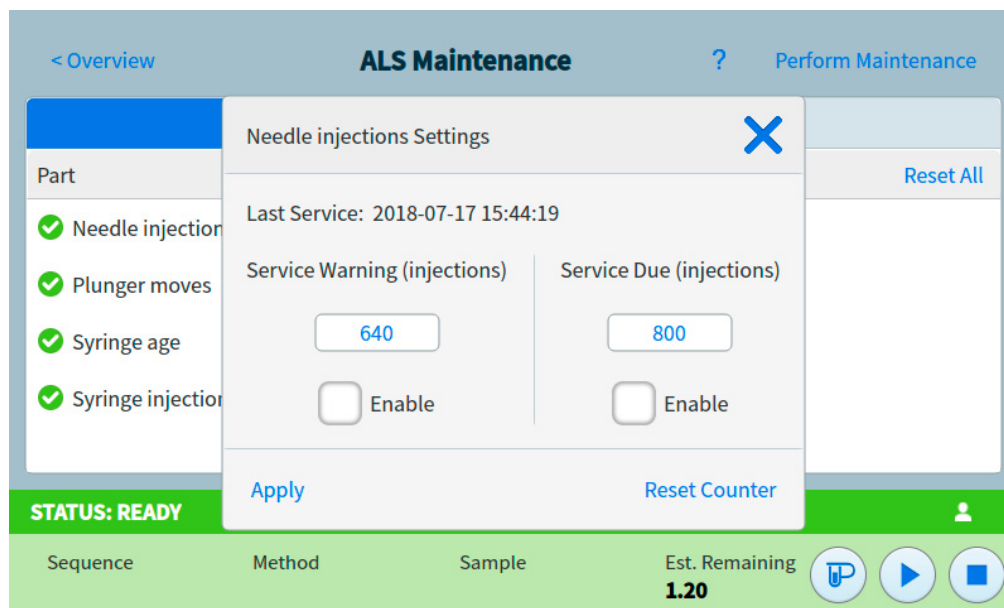

Figure 35. Settings dialog box

- 3 To modify a threshold:
 - a Select the threshold entry. A data entry dialog box appears.
 - b Enter the desired value. See **“Default Thresholds”**.
- 4 To enable or disable a warning, select or deselect **Enable** for the corresponding counter.
- 5 Select **Apply**. The dialog box closes. The entered value is displayed in the corresponding field.
- 6 To reset the counter:
 - a Select **Reset Counter**. A confirmation dialog box appears.
 - b Select **Yes**. The confirmation dialog box closes.
- 7 Select **Apply**.

EMF Counters for Autosamplers

The GC provides access to the counters for the autosampler. The functionality for ALS counters depends on the ALS model and firmware version. In all cases, the GC shows EMF counter status and allows you to enable, disable, and reset the counters using the touchscreen or Browser Interface.

Counters for 7693A and 7650 ALS with EMF-enabled firmware

If using an Agilent 7693 injector with firmware version G4513A.10.8 (or higher), or a 7650 injector with firmware version G4567A.10.2 (or higher), each injector independently tracks its EMF counters.

- The injector counters will increment as long as the injector is used on an 8890 Series GC. You can change positions on the same GC or install the injector on a different GC without losing the current ALS counter data.
- The ALS will report an exceeded limit only when mounted on an 8890 GC.

Counters for ALS with earlier firmware

If using a 7693 or 7650 injector with earlier firmware, or if using another injector model, the GC tracks the counters for that injector. The GC uses the injector serial number to distinguish between installed injectors, but only maintains up to two sets of counters—one for the front injector, and one for the back injector.

- The GC will track injector counters regardless of installed position (front or back inlet). Because the GC tracks the injector serial number, you can change the injector position without losing the counters as long as the injector remains installed on the GC.
- Each time the GC detects a new injector (different model or different serial number), the GC resets the ALS counters in the new injector's position.

EMF Counters for MS Instruments

When configured to an Agilent MS that supports enhanced communications (such as a 5977 Series MSD or 7000C Triple Quadrupole MS), the GC reports the EMF counters as tracked by the MS. The MS provides its own EMF tracking.

When connected to an earlier model MS (for example, a 5975 Series MSD or 7000B MS), the GC tracks the MS counters, not the MS.

For GC-MS, GC-HS, and GC-MS-HS systems, all EMF counters are available at the GC touchscreen. In addition, most counters can be reset at the GC touchscreen. Some counter types, for example, a counter which requires a calibration to be performed on a headspace sampler, cannot be reset at the GC touchscreen, but can still be viewed.

Logs View	134
Maintenance logs	135
Run log	135
System log	135

This section describes the log features available on the Agilent 8890 GC.

Logs View

The Logs view provides listings of GC events including maintenance events, run events, and system events, sorted by date/time. See **Figure 36**.

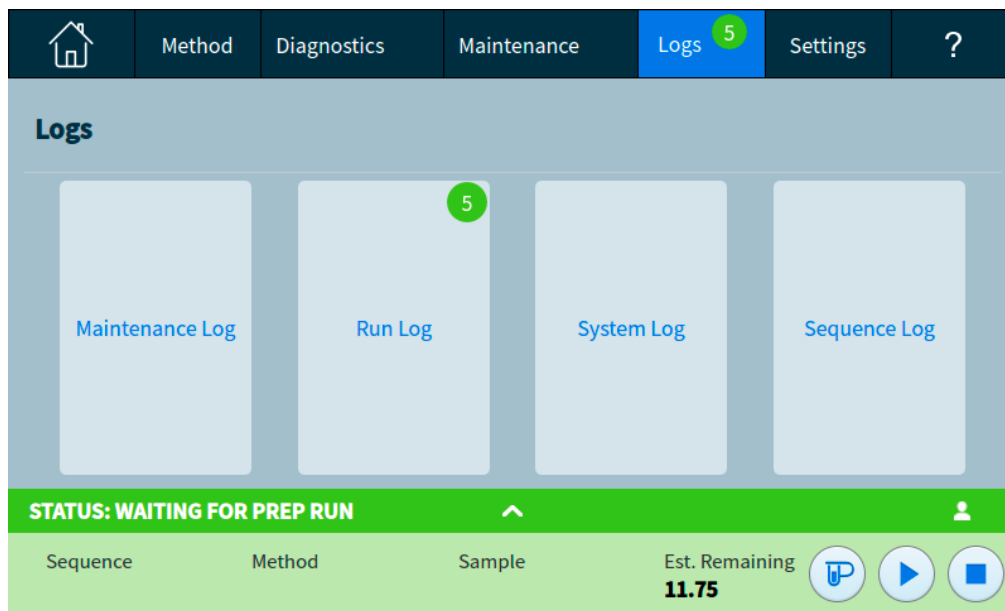

Figure 36. Logs view

Selecting one of the buttons on the Logs view brings up the corresponding log page. See **Figure 37**.

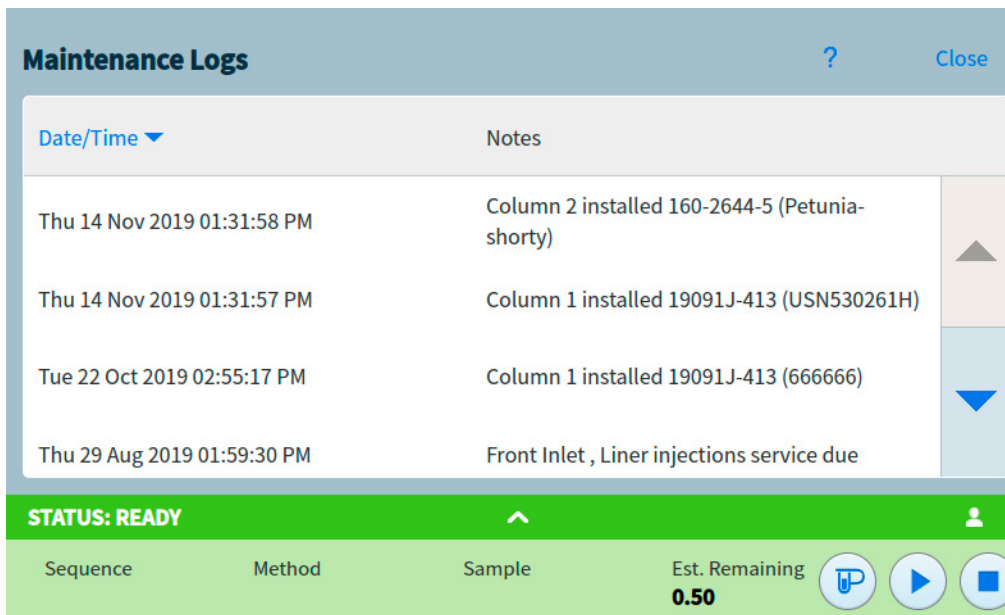

Figure 37. Maintenance Logs page

For Maintenance and System log items, items are sorted by date and time. For Run log items, relative time (from the start of the run) is used.

Use the scroll buttons to scroll through the log entries.

Select **Cancel** to return to the Logs view.

Maintenance logs

The maintenance log contains entries made by the system when:

- A system event occurs (for example, a detector shutdown)
- Any component counter reaches a monitored limit

The log entry contains a description of the maintenance event and the date/time that the event occurred. In addition, each user task related to the counter is recorded in the log, including resetting, enabling, or disabling monitoring, and changing limits or units (cycles or duration).

Run log

The run log is cleared at the start of each new run. During the run, any deviations from the planned method (including touchscreen or Browser Interface intervention) are listed in the run log table.

System log

The system log records significant events that occur during GC operation. Some of the events also appear in the run log if they occur during a run.

- About Settings 138
- Service Mode 139
- About 141
- Calibration 142
 - Maintaining EPC calibration—inlets, detectors, PCM, PSD, and AUX 142
 - To zero a specific flow or pressure sensor 143
- System Settings 145
 - Configuring the IP address for the GC 145
 - To set system date and time 147
 - To change the system locale 148
 - To set system power saving features 149
 - To access stored run data 150
 - To control Browser Interface access 150
 - To run the system setup routine 151
- Tools 153
 - Performing a column compensation run 153
- Power 155

About Settings

The Settings view provides access to configuration and system settings for the GC.

Selecting **Settings** on the touchscreen control ribbon brings up the Settings view.

See **Figure 38**.

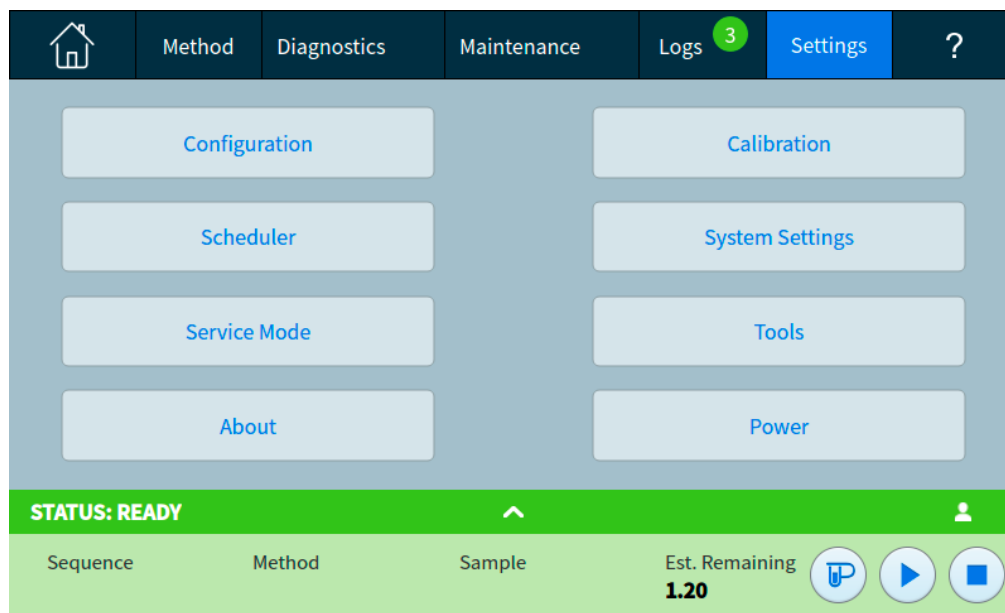

Figure 38. Settings view

- Select **Configuration** to access the GC configuration settings. See **“Configuration”**.
- Select **Scheduler** to access the GC Instrument Schedule settings. See **“Resource Conservation”**.
- Select **Service Mode** to access the service mode settings for the GC. See **“Service Mode”**.
- Select **About** to get information about this GC. See **“About”**.
- Select **Calibration** to access the calibration functions. See **“Calibration”**.
- Select **System Settings** to access the system settings for the GC, including setting the network address, system date and time, touchscreen settings, system setup information, and so on. See **“System Settings”**.
- Select **Tools** to access the Tools page. See **“Tools”**.
- Select **Power** to access the Power dialog box. See **“Power”**.

Service Mode

The Service Mode feature allows you to view the installed GC system component details. This includes serial numbers, firmware versions, voltages, currents, temperatures, and so on.

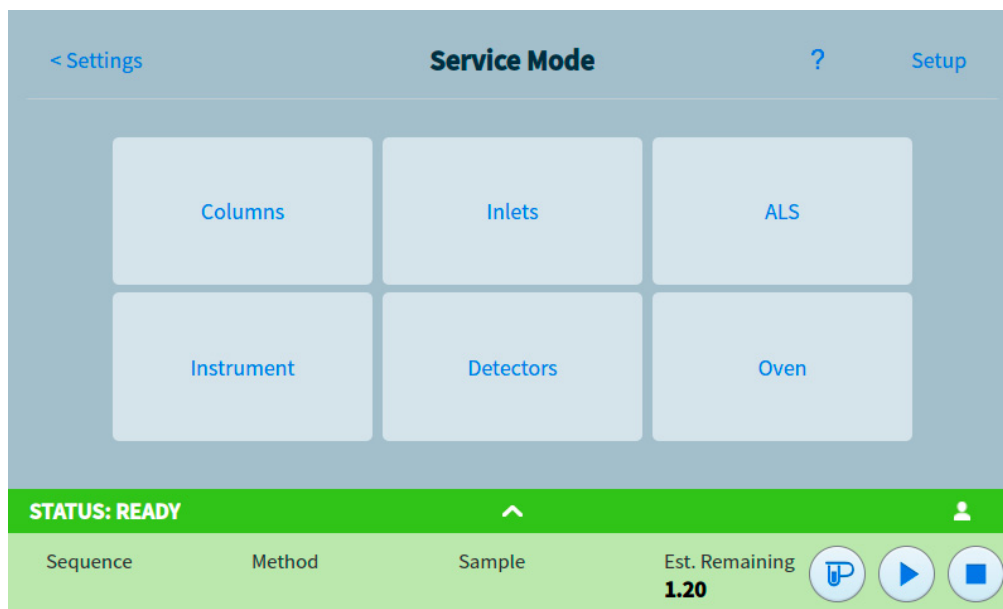

Figure 39. Service Mode page

To view the specifications for the various components of your instrument:

- 1 Select the desired component type. The Service Mode page for the selected component appears. See [Figure 40](#).

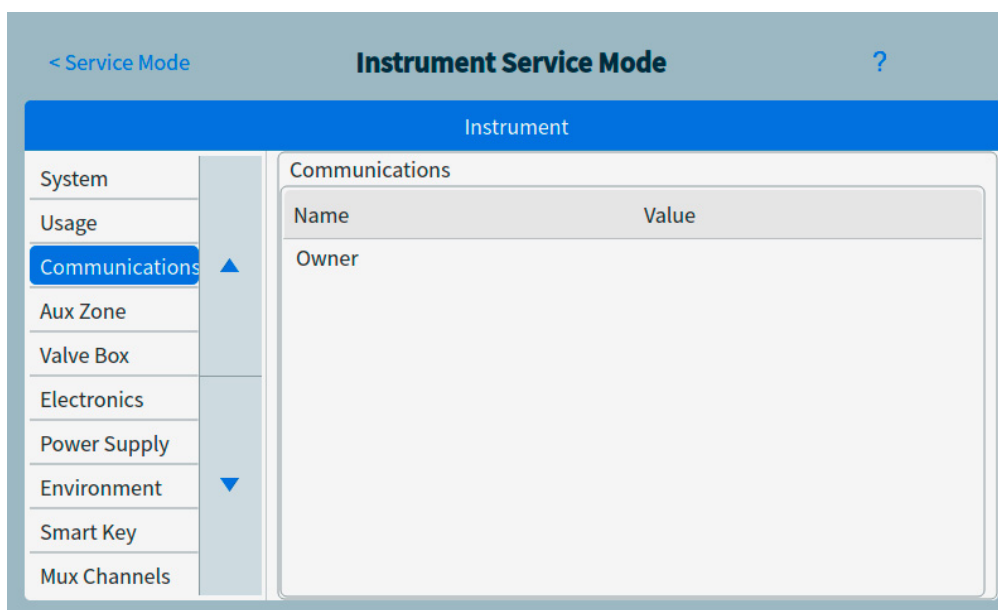

Figure 40. Instrument Service Mode page

- 2 Use the page selection buttons on the left side of the page to display related functional information.

About

The About feature allows you to view details about the GC.

The About screen lists the GC manufacturing date, serial number, firmware revision, and help and information revision.

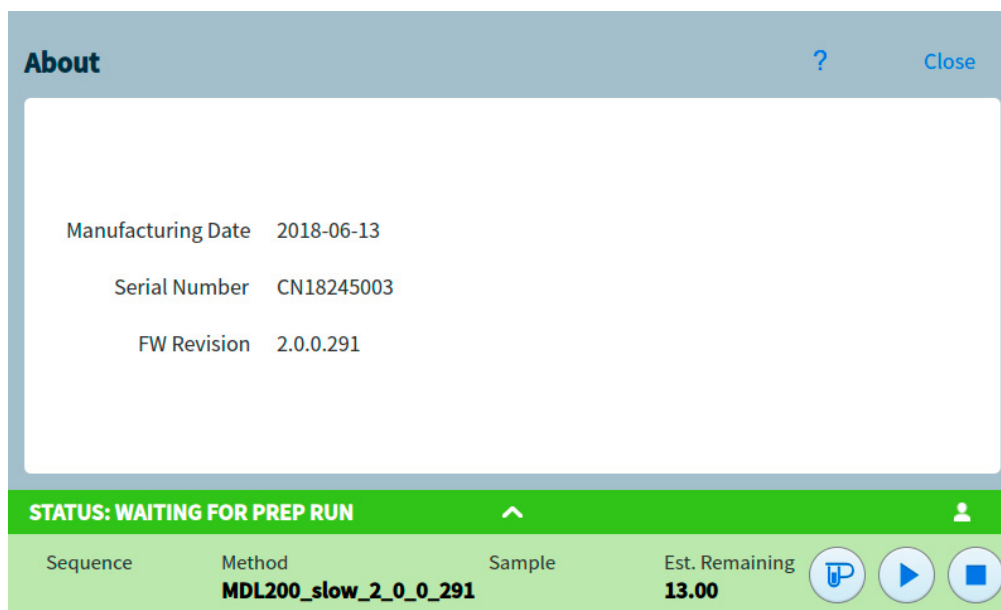

Figure 41. About page

Select **Close** on the About page to return to the Settings view.

Calibration

Calibration allows you to adjust the following items (when available):

- ALS
- Inlets
- Oven
- Detectors
- EPC modules

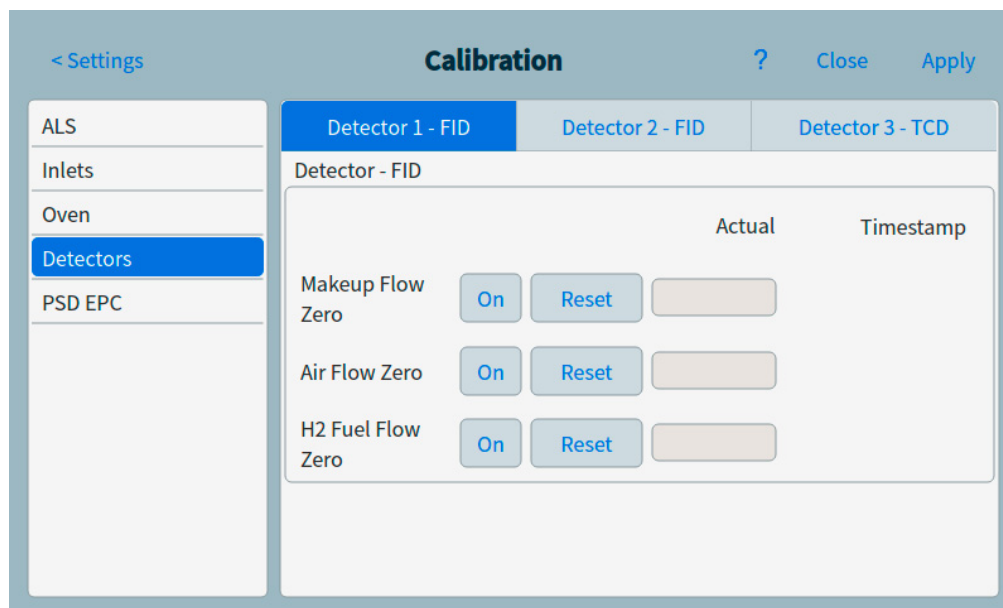

Figure 42. Calibration page

To change the calibration settings:

- 1 Use the page selection buttons on the left side of the page to display related functional information.
- 2 Make changes to calibration settings as desired. See **“Maintaining EPC calibration—inlets, detectors, PCM, PSD, and AUX”**, **“To zero a specific flow or pressure sensor”** for more information.
- 3 Select **Apply**. The entered changes are saved to the GC.

Maintaining EPC calibration—inlets, detectors, PCM, PSD, and AUX

The EPC gas control modules contain flow and/or pressure sensors that are calibrated at the factory. Sensitivity (slope of the curve) is quite stable, but zero offset requires periodic updating.

Flow sensors

All inlet modules use flow sensors, as do PSDs, and channel 1 of a PCM. If the **Auto flow zero** feature is selected, they are zeroed automatically after each run. This is the recommended setting. They can also be zeroed manually—see **“To zero a specific flow or pressure sensor”**.

Pressure sensors

All EPC control modules use pressure sensors. They must be zeroed individually. There is no automatic zero for pressure sensors.

Auto Zero flow

A useful calibration option is **Auto Zero flow**. When selected, after the end of a run, the GC shuts down the flow of gases to an inlet, waits for the flow to drop to zero, measures and stores the flow sensor output, and turns the gas back on. This takes about two seconds. The zero offset is used to correct future flow measurements.

Auto zero septum purge

This is similar to **Auto zero flow**, but is for the septum purge flow.

Zero conditions

Flow sensors are zeroed with the carrier gas connected and flowing.

Pressure sensors are zeroed with the supply gas line disconnected from the gas control module.

Zero intervals

Table 15 Flow and Pressure Sensor Zero Intervals

Sensor type	Module type	Zero interval
Flow	All	Use Auto flow zero and/or Auto zero septum purge
Pressure	Inlets	
	Small capillary columns (id ≤ 0.32 mm)	Every 12 months
	Large capillary columns (id > 0.32 mm)	At 3 months, at 6 months, then every 12 months
	Auxiliary channels	Every 12 months
	Detector gases	Every 12 months

To zero a specific flow or pressure sensor

- 1 Select **Settings > Calibration > Detectors**, and select the desired detector.
- 2 Select **On** next to the desired sensor to zero it.
- 3 For **Flow sensors**. Verify that the gas is connected and flowing (turned on).

- 4 For **Pressure sensors**. Disconnect the gas supply line at the back of the GC. Turning it off is not adequate; the valve may leak.
- 5 Reconnect any gas line disconnected in the previous step and restore operating flows.

System Settings

System settings includes setting the network address, system date and time, access and storage details, locale setting, and system setup information.

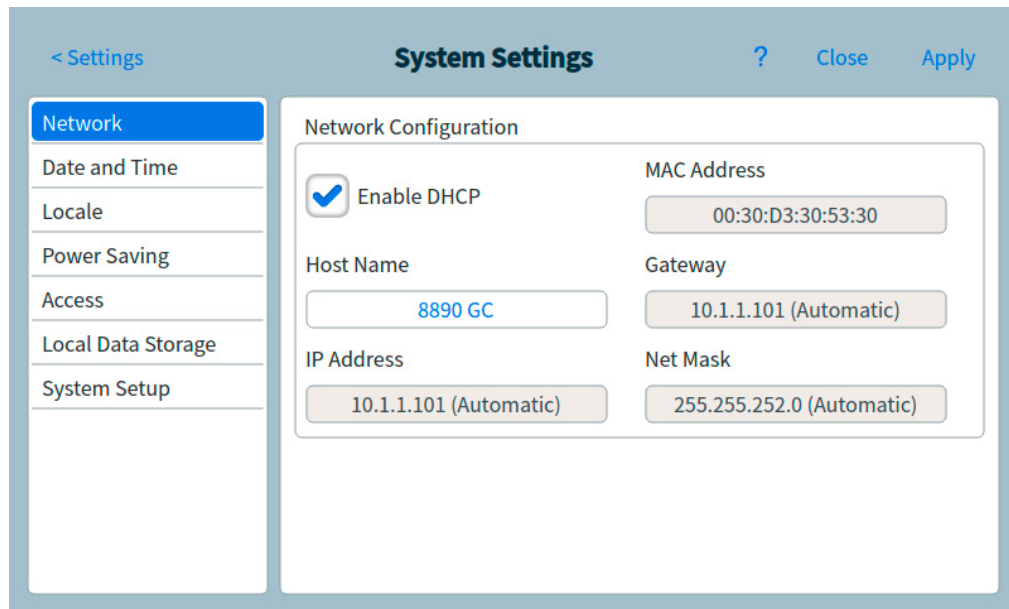

Figure 43. System Settings page

Use the page selection buttons on the left side of the page to display related functional information.

Select **Apply** to save any changes made to the GC.

Configuring the IP address for the GC

For network (LAN) operation, the GC needs an IP address. It can get this from a DHCP server, or it can be entered directly from the touchscreen. In either case, see your LAN administrator for appropriate settings.

To use a DHCP server

- 1 From the System Settings page, select the **Network** page selection button. The Network Configuration page appears. See **Figure 44**.

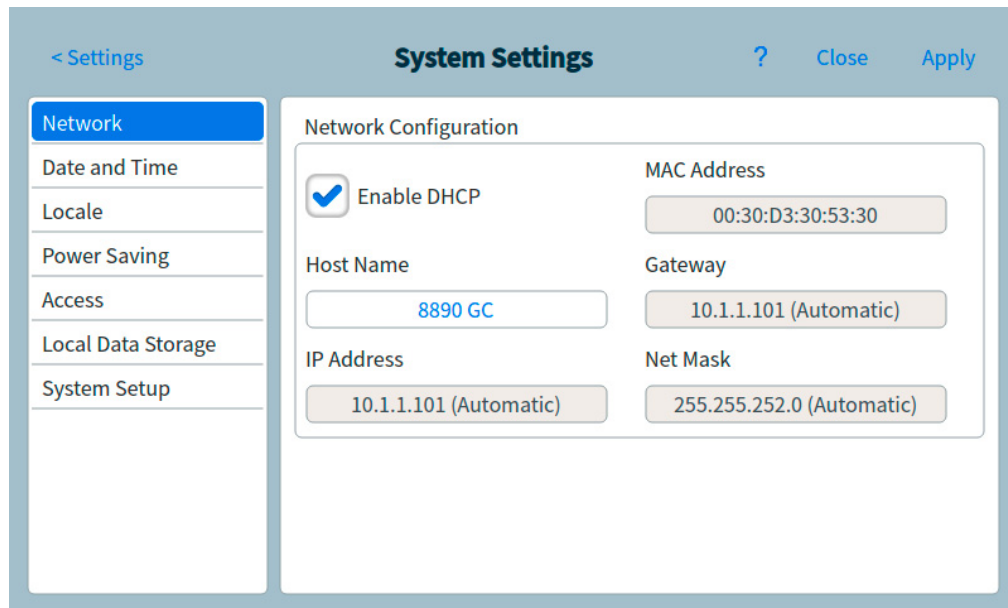

Figure 44. Network Configuration page

- 2 Select **Enable DHCP**.
- 3 Select **Apply**.
- 4 If prompted, restart the GC. See **"Power"**.

To set the LAN address at the touchscreen

- 1 From the System Settings page, select the **Network** page selection button.
- 2 If **Enable DHCP** is selected:
 - a Deselect **Enable DHCP**.
 - b When prompted, restart the GC. See **"Power"**.
 - c Return to the System Settings page
- 3 Enter the **Host Name** or the **IP Address** in its corresponding field
- 4 Enter the **Gateway** number in the corresponding field.
- 5 Enter the subnet mask in the **Net Mask** field.
- 6 Select **Apply**.
- 7 If prompted, restart the GC. (See **"Power"**.)

To set system date and time

- 1 From the System Settings page, select the **Date and Time** page selection button. The Date and Time page appears. See **Figure 45**.

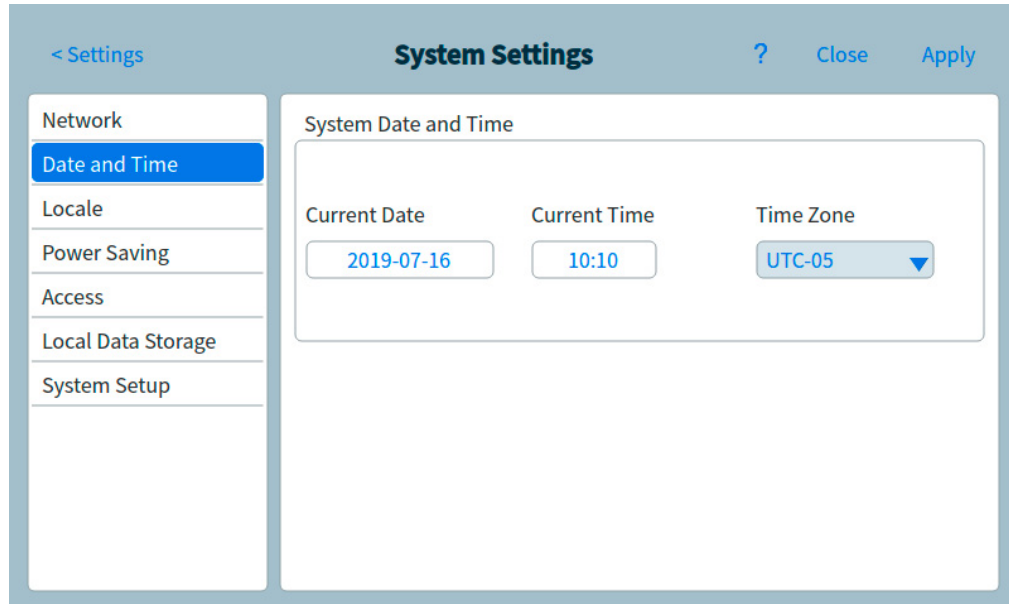

Figure 45. System Settings page

- 2 Select the **Current Date** field. A keypad appears.
- 3 Enter the current date.
- 4 Select **Apply**. The keypad closes. The selected date is displayed in the field.
- 5 Select the **Current Time** field. A keypad appears.
- 6 Enter the current time.
- 7 Select **Apply**. The keypad closes. The selected time is displayed in the field.
- 8 Choose the appropriate **Time Zone** from the corresponding drop-down list box.
- 9 Select **Apply**. The GC saves all of the changes made.

To change the system locale

- 1 From the System Settings page, select the **Locale** page selection button. The Locale Settings page appears. See **Figure 46**.

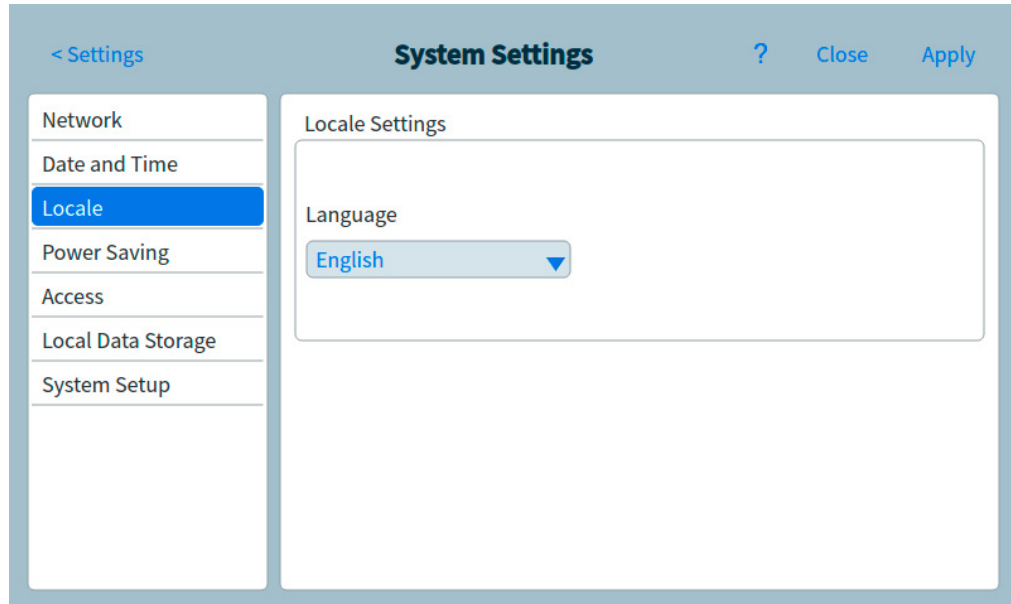

Figure 46. Locale Settings page

- 2 Choose the desired **Language** from the corresponding drop-down list box.
- 3 Select **Apply**. The GC saves the change made. The system is changed to the selected locale. This may take a few moments.

To set system power saving features

- 1 From the System Settings page, select the **Power Saving** page selection button. The Power Saving page appears. See [Figure 47](#).

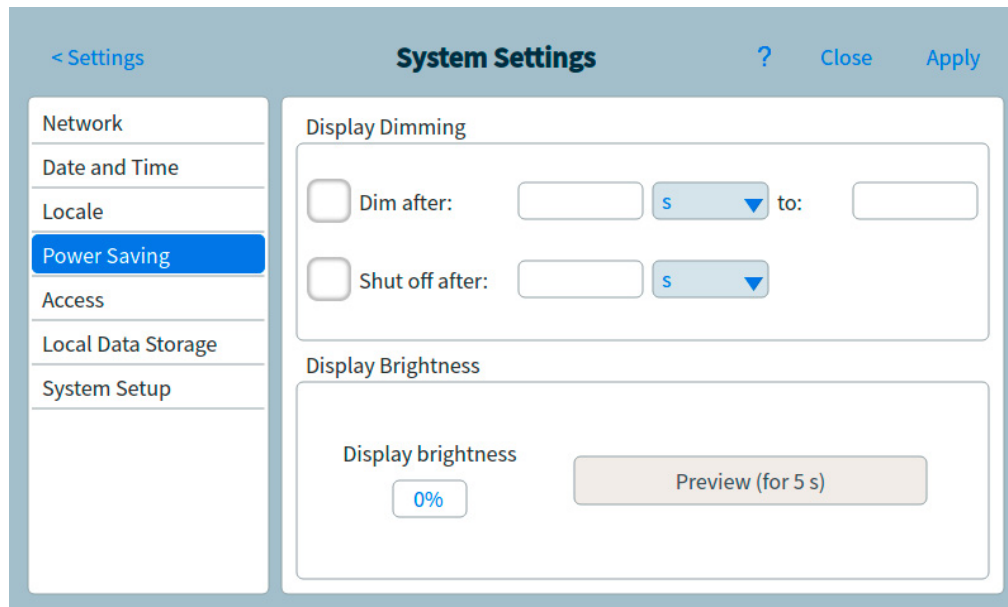

Figure 47. Power Saving page

- 2 To enable display dimming:
 - a Select the **Dim display after:** check box. The corresponding data entry fields and drop-down list box are enabled.
 - b Use the data entry fields and drop-down list box to set the desired values.
- 3 To enable display shut off:
 - a Select the **Shut off display after:** check box. The corresponding data entry field and drop-down list box are enabled.
 - b Use the data entry field and drop-down list box to set the desired values.
- 4 To change the default display brightness:
 - a Select the **Display brightness** field. A keypad appears.
 - b Enter the desired brightness value.
 - c Select **Apply**. The keypad closes. The selected value is displayed in the **Display brightness** field.
 - d Select **Preview (for 5 seconds)**. The screen brightness adjusts to the specified value for five seconds.

NOTE

The dim display value must be less than the display brightness value.

The display brightness value must be greater than 0.

- 5 Select **Apply**. The GC saves all of the changes made.

To access stored run data

If using the Browser Interface to perform runs and collect data, the GC stores the result data internally. To access that data:

- 1 From the **System Settings** page, select **Access**. Note the displayed PIN.
- 2 Select **Local Data Storage**. Note the path to the GC share.
- 3 On your PC, map a network drive to the GC share. When prompted, connect using the credentials:

user: results

password: the PIN (default: 0000).

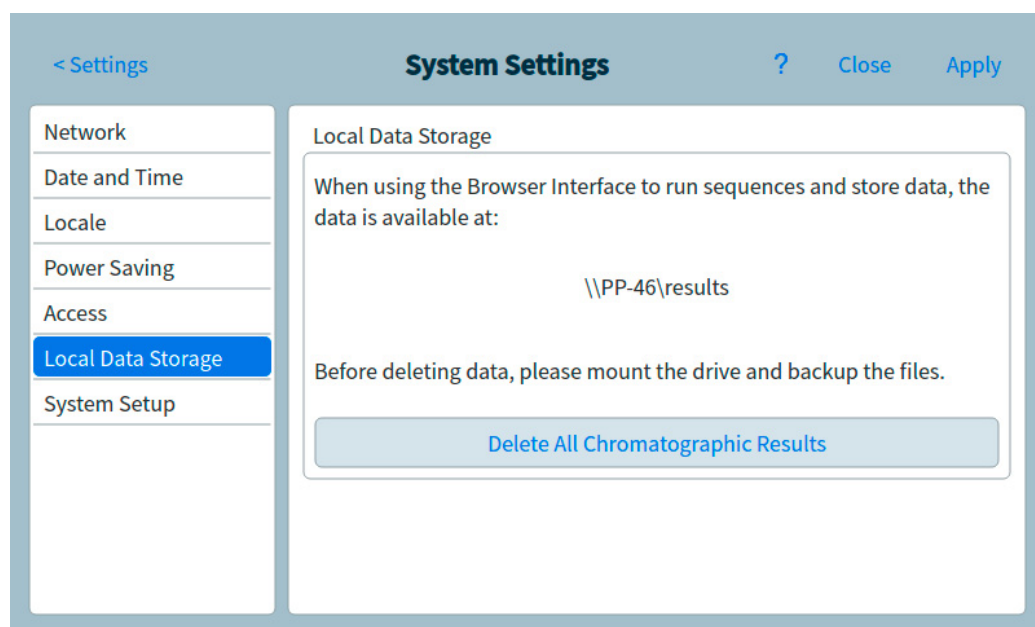

To control Browser Interface access

The GC is set so that a four-digit PIN must be used to perform the following actions for your GC:

- Delete run data.
- Mount a share drive.

By default, the PIN is set to 0000. Additionally, you may choose to require the PIN to access the Browser Interface. To set the PIN:

- 1 From the **System Settings** page, select **Access**.
- 2 Select the four-digit PIN to input a new PIN.
- 3 If desired, select the checkbox next to Access Browser Interface to require the PIN for Browser Interface access.

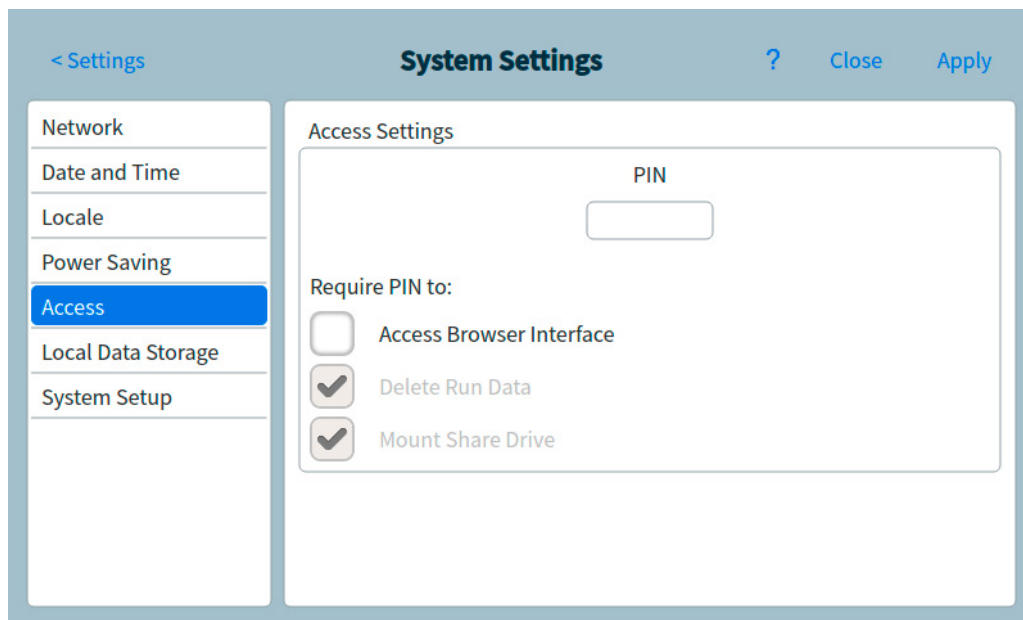

To run the system setup routine

- 1 From the System Settings page, select the **System Setup** page selection button. The System Setup page appears. See **Figure 48**.

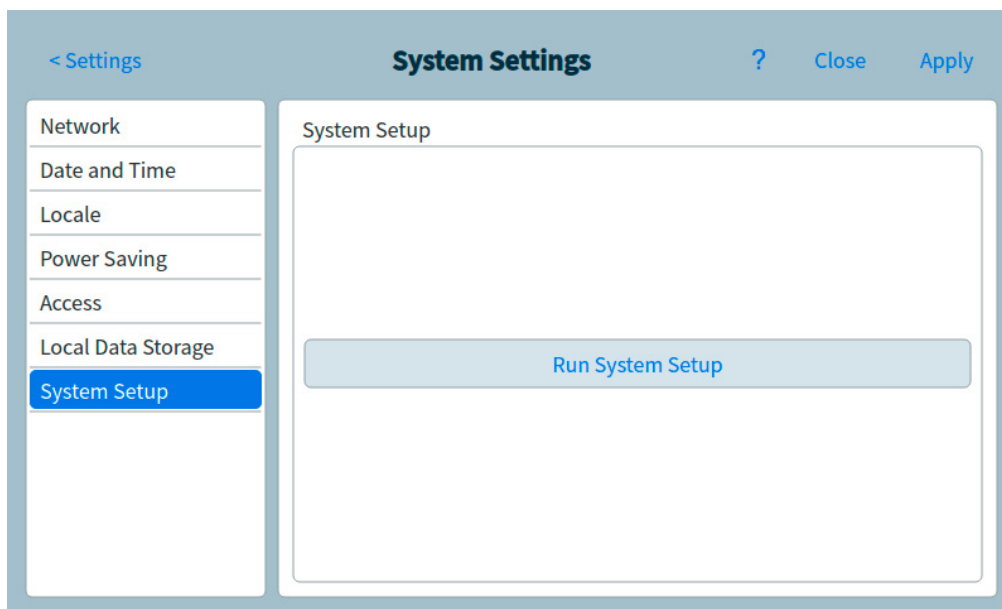

Figure 48. System Setup page

- 2 Select **Run System Setup**. A set of demonstration slides is displayed on the touchscreen. These slides illustrate the primary steps for setting up your GC for use. Certain slides allow you to enter setup information which is available elsewhere in the GC user interface. These items include:

- System data and time. See **“To set system date and time”**
- Displayed pressure units.
- System network address. See **“Configuring the IP address for the GC”**
- Inlet and detector gas types. See **“Inlet Configuration”**

Additionally, you are asked whether the GC is connected to a data system, and prompted to perform checkout. See **“Chromatographic Checkout”**.

- 3** Follow the instructions on the screen to view the demonstration.

Tools

The Tools page allows you to perform column compensation runs for the installed columns on the GC. See **Figure 49**.

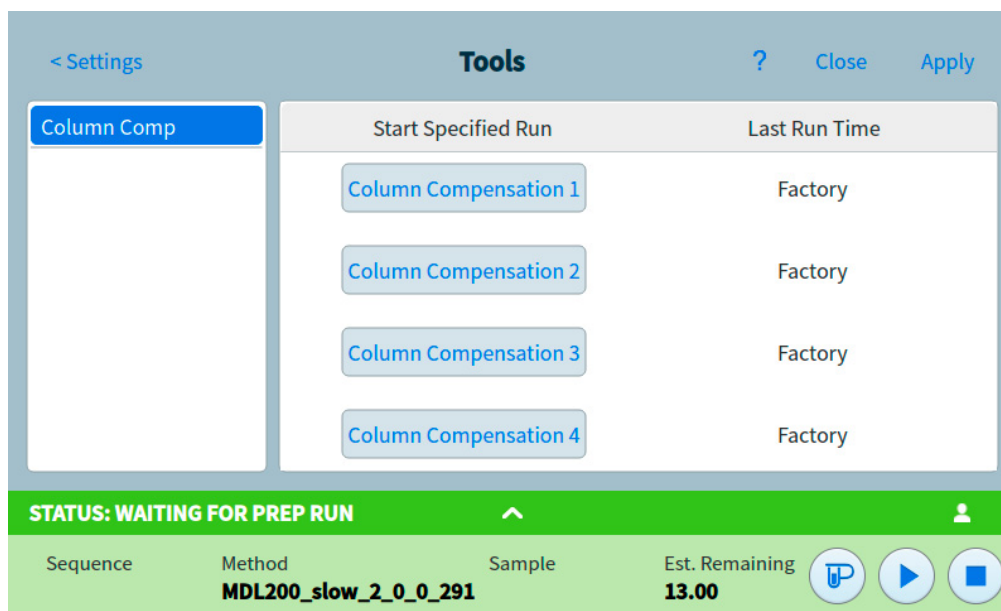

Figure 49. Tools page

In temperature programmed analysis, bleed from the column increases as the oven temperature rises. This causes a rising baseline which makes peak detection and integration more difficult. Column compensation corrects for this baseline rise.

A column compensation run is made with no sample injected. The GC collects an array of data points from any installed detectors. If a detector is not installed or is turned off, that part of the array is filled with zeros.

Each array defines a set of curves, one for each detector, that can be subtracted from the real run to produce a flat baseline.

When a connected data system is used, the raw signal, and the column compensation data, is output to the data system so that a compensated, and uncompensated, signal are available for analysis.

Performing a column compensation run

All conditions must be identical in the column compensation run and the real run. The same detector and column must be used, operating under the same temperature and gas flow conditions.

Up to four column compensation runs can be made. The GC retains the results of these runs for later use.

Any column compensation run can then be used to compensate a rising baseline during a run.

- 1 With the Tools page displayed, as shown in [Figure 49](#), select the desired **Column Compensation** in the **Start Specified Run** column. The GC performs the column compensation run. No injection occurs as a part of this run.
- 2 Use the connected data system to edit the method. Set the detector to **Subtract from Signal: Column compensation Curve #x** (where **x** is the number of the column compensation run).
- 3 Run the method. The results use the column compensation run data to compensate for baseline changes in the column.

Power

The Power Options dialog box allows you to shut down or restart the GC from the touchscreen.

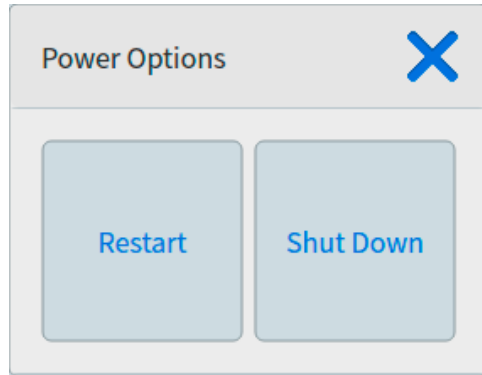

Figure 50. Power Options dialog box

To restart the GC, select **Restart**. The GC restarts.

To shut down the GC, select **Shut Down**. The GC shuts down.

About Configuration	158
Configuration Changes	159
Valve Configuration	161
Inlet Configuration	163
Columns	165
To configure a single column	166
To configure a packed column	167
To configure a composite column	167
Additional notes on column configuration	169
To configure multiple columns	169
Inlets and outlets	170
A simple example	170
Slightly more complex example	171
Oven	172
Detector Configuration	174
Analog Output Settings	175
MSD Configuration	176
System-level communications	176
MSD configuration	176
GC/MS systems	177
To enable or disable MS communications	179
To use the GC when the MS is shut down	179
Headspace Sampler	180
Miscellaneous Settings	182
LTM Columns	184
Valve Box	185
PCMs	186
Aux EPCs	187

About Configuration

A device's configuration properties are constant for an instrument hardware setup, unlike method settings which can change from sample run to sample run. Two example configuration settings are the gas type flowing through a pneumatic device and the operating temperature limit of a device. The GC will try to set any configuration properties necessary for any device that it finds installed. For example, if the GC knows it is connected to an MSD, it will automatically configure the MSD heated transfer line. The only settings that need to be configured manually are items that can be changed depending on your analysis, such as installed columns and carrier gas type, or an item which may be installed in a non-standard location. For example, an auxiliary EPC module installed in an inlet EPC module position may require manual configuration.

Ensure all devices have been configured correctly prior to running any samples.

Configuration Changes

Configure a new device

Upon startup, the GC will attempt to identify any device that was not installed prior to shutdown. The GC may require you to provide additional information, such as the type of device installed, or which heater a given device was attached to. To configure a new device:

- 1 Select **Settings** > **Service Mode** > **Setup**.

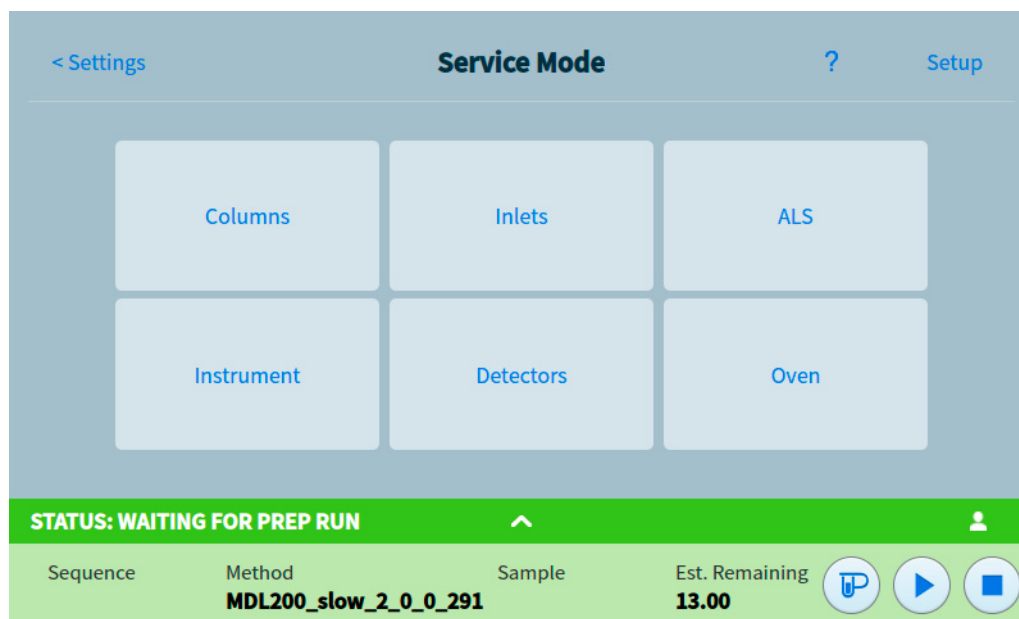

- 2 Select the new device type from the list on the left side of the screen.
- 3 Fill out any required parameters. Potential parameters include:
 - Type: Select the type of device installed, such as the MS model.
 - Line voltage.
 - Heater(s): Select the heater(s) that the device is plugged into.
 - Sensor(s): Select the sensor the device is plugged into.
 - LVDS: Select the LVDS channel the device is plugged into.
 - Valve: Select the valve used to control your inlet's cryo.
 - Presence
- 4 Select **Apply** to save the changes to your GC.

Configure an existing device

To change the configuration properties for a device that has already been configured:

- 1 Select **Settings**. The Settings view appears. See **Figure 51**.

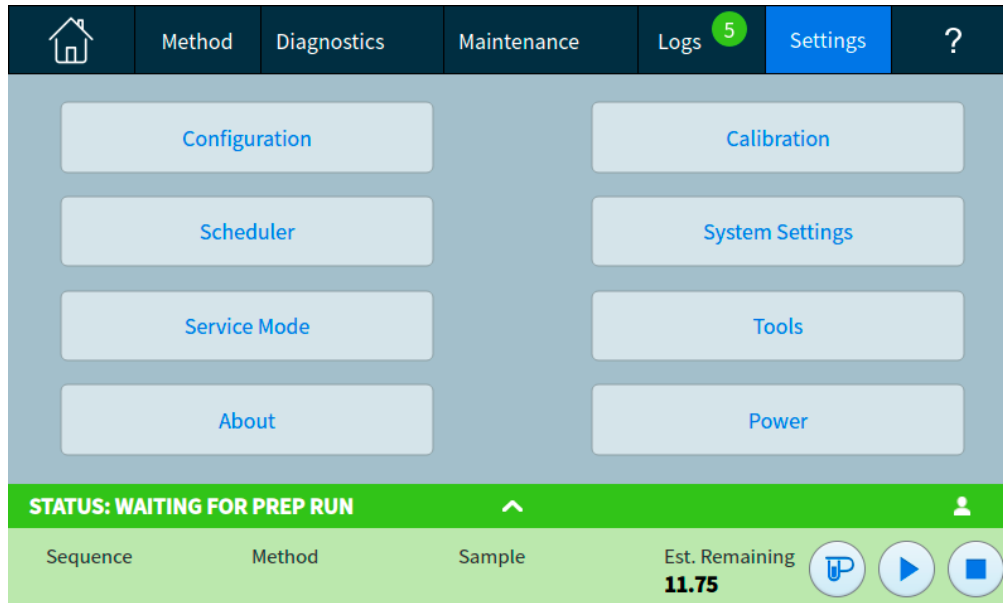

Figure 51. Settings view

- 2 Select **Configuration**.

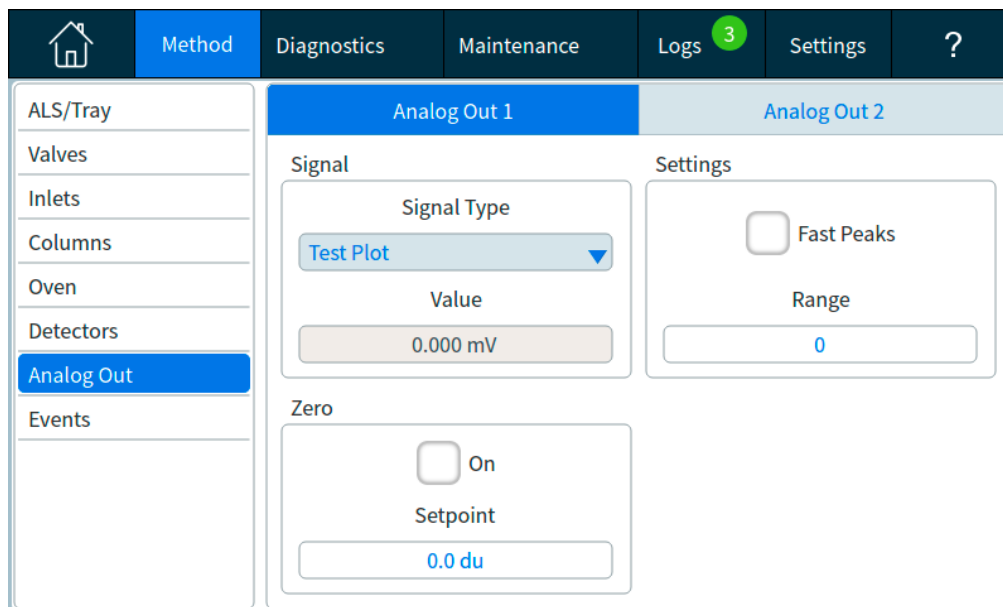

Figure 52. Configuration page

- 3 Select the desired device type from the list on the left side of the screen. The properties for the selected device type appear on the right side of the screen.
- 4 Scroll to the device setting and change the property. This can involve making a selection from a list, or entering a numeric value.
- 5 When all required changes have been made, select **Apply**. The entered changes are saved to the GC.

Valve Configuration

Valve configuration provides the ability to specify valve types, loop volumes, step times, and BCD inversion settings. BCD inversion allows for changing the BCD input (1's become 0's and 0's become 1's). This feature accommodates coding convention differences between valve manufacturers.

Note that the Valves page appears regardless of whether any valves are currently installed in the GC.

To configure valves

- 1 Select **Settings > Configuration > Valves**. See **Figure 53**.

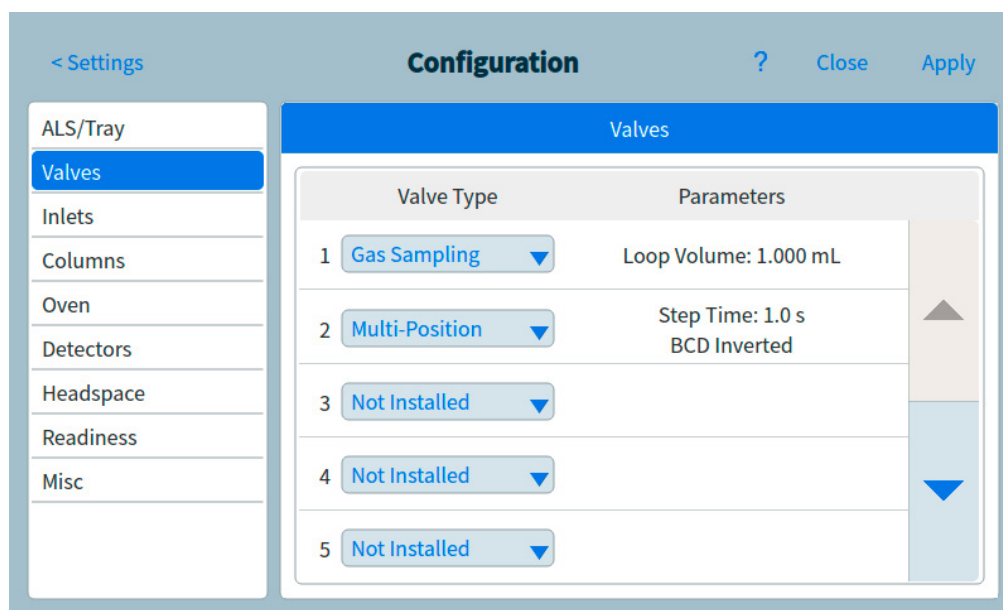

Figure 53. Valves page

- 2 Use the **Valve Type** drop-down list box to select the corresponding valve type. The possible valve types are:
 - **Gas Sampling** Two-position (load and inject) valve. In load position, an external sample stream flows through an attached (gas sampling) or internal (liquid sampling) loop and out to waste. In inject position, the filled sampling loop is inserted into the carrier gas stream. When the valve switches from Load to Inject, a run starts if one is not already in progress.
 - **Switching** Two-position valve with four, six, or more ports. These are general-purpose valves used for such tasks as column selection, column isolation, and many others.
 - **Multi-position** Also called a stream selection valve. It selects one from a number of gas streams and feeds it to a sampling valve. The actuator may be ratchet- (advances the valve one position each time it is activated) or motor-driven.
 - **Other** Something else.
 - **Not installed** Self-explanatory.

11 Configuration

- 3 Enter the loop volume using the corresponding **Loop Vol.** text field.
- 4 Enter the **Step Time** in the corresponding test field
- 5 For multi-position valves, use the **BCD Inverted** drop-down list box to select the whether to invert the BCD input.
- 6 Select **Apply**. The entered changes are saved to the GC.

Inlet Configuration

- 1 Select **Settings > Configuration > Inlets**. The properties for the selected device type appear on the right side of the screen. See **Figure 54**.

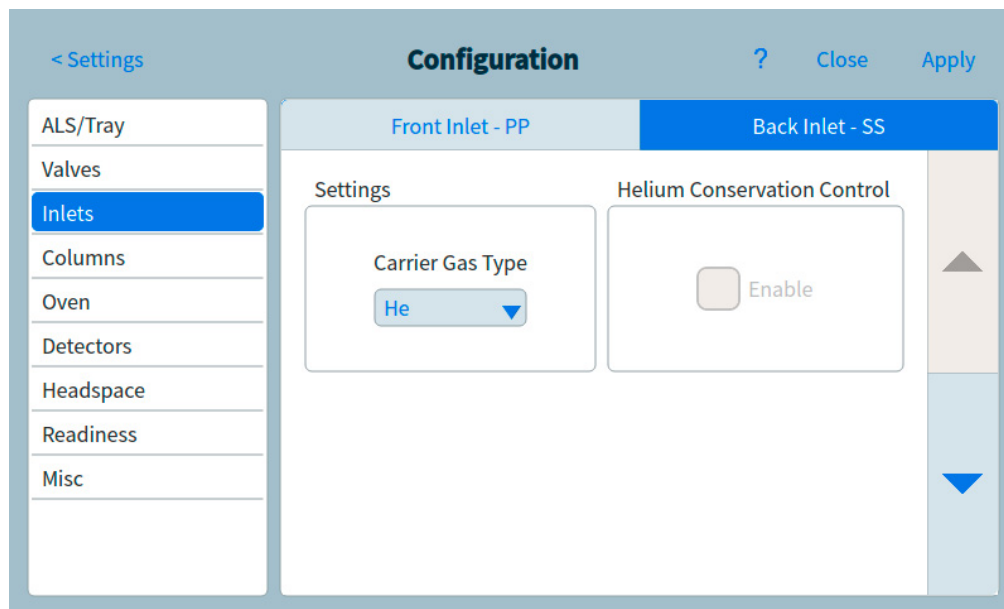

Figure 54. Inlets page

- 2 Select the desired gas type from the **Carrier Gas Type** drop-down list box.
- 3 Select **Enable** under **Readiness** if using this inlet. If Readiness is disabled, the GC becomes ready even if this device has not reached or cannot reach its setpoints.

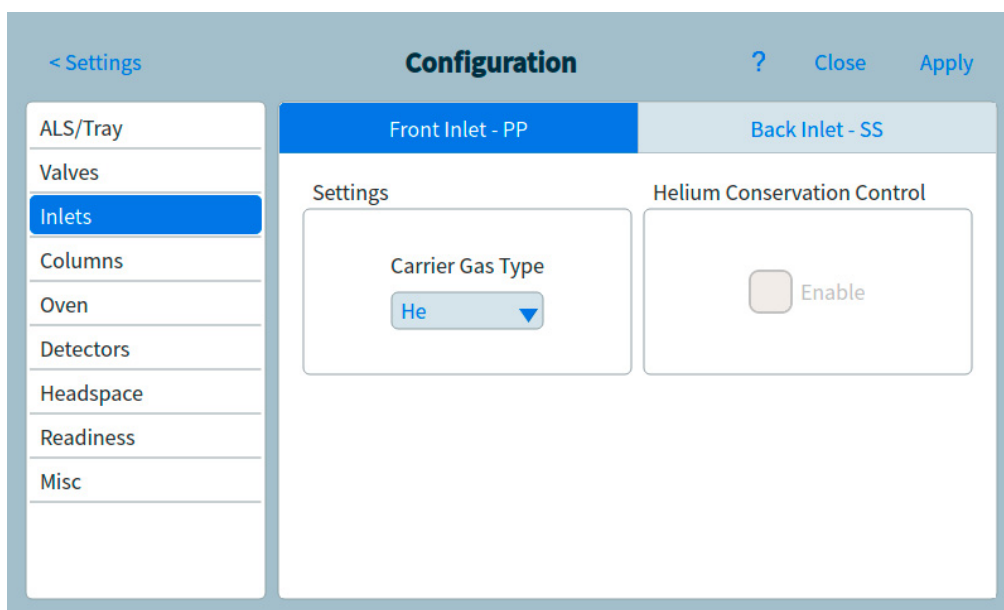

Figure 55. Flow Path page

11 Configuration

- 4 Adjust the settings for the second inlet as necessary.
- 5 Select **Apply**. The entered changes are saved to the GC.

Columns

Length The length, in meters, of a capillary column. Enter **0** for a packed column or if the length is not known.

Diameter The inside diameter, in millimeters, of a capillary column. Enter **0** for a packed column.

Film thickness The thickness, in microns, of the stationary phase for capillary columns.

Inlet Identifies the source of gas for the column.

Outlet Identifies the device into which the column effluent flows.

Thermal zone Identifies the device that controls the temperature of the column.

In_Segment Length The length, in meters, of the In Segment of a composite column. Enter **0** to disable. See [“To configure a composite column”](#).

Out_Segment Length The length, in meters, of the Out Segment of a composite column. Enter **0** to disable. See [“To configure a composite column”](#).

Segment 2 Length The length, in meters, of the Segment 2 of a composite column. Enter **0** to disable. See [“To configure a composite column”](#).

Column ID lock The Column ID lock can either be set manually, or will be automatically set when using a column with a SmartID key. When a column is locked, the column dimensions can not be edited through the Browser Interface, touchscreen, or a connected data system. If a locked column does not have an associated SmartID key, it may be manually unlocked via the touchscreen.

The screenshot shows the 'Configuration' window for 'Column 1'. The sidebar on the left is titled '< Settings' and includes a list of configuration categories: ALS/Tray, Valves, Inlets, Columns (highlighted in blue), Oven, Detectors, Headspace, Readiness, and Misc. The main content area is titled 'Configuration' and has tabs for Column 1 through Column 6. A message states 'No Smart Key is present.' Below this, a 'Settings' section contains several dropdown menus: 'Column Type' set to 'Capillary', 'Thermal zone' set to 'GC Oven', 'Inlet connection' set to 'Front Inlet', and 'Outlet connection' set to 'Front Detector'. At the bottom of the settings section are three input fields: 'Length' with the value '10.00 m', 'Diameter' with the value '530.00 µm', and 'Film Thickness' with the value '0.17 µm'. The interface also includes navigation buttons like '?', 'Close', and 'Apply' at the top right.

To configure a single column

You define a capillary column by entering its length, diameter, and film thickness. You then enter the device controlling the pressure at the Inlet (end of the column), the device controlling the pressure at the column Outlet, and the Thermal zone that controls its temperature.

With this information, the instrument can calculate the flow through the column. This has great advantages when using capillary columns because it becomes possible to:

- Enter split ratios directly and have the instrument calculate and set the appropriate flow rates.
- Enter flow rate or head pressure or average linear velocity. The instrument calculates the pressure needed to achieve the flow rate or velocity, sets that, and reports all three values.
- Perform splitless injections with no need to measure gas flows.
- Choose any column mode. If the column is not defined, your choices are limited and vary depending on the inlet. Except for the simplest configurations, such as a column connected to a specific inlet and detector, we recommend that you begin by making a sketch of how the column will be connected.

To configure a capillary column:

- 1 Select **Settings > Configuration > Columns**.
- 2 Under Column Type, select **Capillary**.
- 3 Input the Length, Diameter, and Film Thickness into the appropriate fields.

If you do not know the column dimensions—they are usually supplied with the column—or if you do not wish to use the GC calculating features, enter **0** for either **Length** or **Diameter**. The column will be not defined.

NOTE

Agilent recommends always defining capillary columns.

- 4 Under Inlet connection, select the desired inlet from the dropdown menu. Selections include the installed GC inlets, and installed Aux and PCM channels.
- 5 Under Outlet connection, select the desired outlet from the dropdown menu.
 - Available choices include the installed Aux and PCM channels, front and back detectors, and MSD.
 - When a detector is selected, the outlet end of the column is controlled at 0 psig for the FID, TCD, FPD+, NPD, and ECD or vacuum for the MSD.
 - If the column exhausts into a nonstandard detector or environment (neither ambient pressure nor complete vacuum), select **Other** and enter the outlet pressure.
- 6 Under Thermal zone, select the desired thermal zone from the dropdown menu.
- 7 Set the Min Temp, Max Temp, and Max Program Temp for your column.
- 8 Set the column's
 - Manufacturer
 - Date Manufactured
 - Serial Number

- Part Number
 - Phase Tag
 - Column ID Lock. If using an optional barcode scanner, this will be set to **Locked** by the data system. Normally, set to **Unlocked** when not using a barcode scanner.
- 9 Set **In_Segment Length**, **Out_Segment Length**, and **Segment 2 Length** to **0** to disable composite column configuration. See [“To configure a composite column”](#) for information.
 - 10 Select **Apply**. This saves the changes to the GC.

To configure a packed column

To configure a packed column:

- 1 Select **Settings > Configuration > Columns**.
- 2 Under Column Type, select **Packed**.
- 3 Set the Min Temp, Max Temp, and Max Program Temp for your column.
- 4 Set the column's
 - Manufacturer
 - Date Manufactured
 - Serial Number
 - Part Number
 - Phase Tag
 - Column ID Lock. If using an optional barcode scanner, this will be set to **Locked** by the data system. Normally, set to **Unlocked** when not using a barcode scanner.
- 5 Under Inlet connection, select the desired inlet from the dropdown menu. Selections include the installed GC inlets, and installed Aux and PCM channels.
- 6 Under Outlet connection, select the desired outlet from the dropdown menu.
 - Available choices include the installed Aux and PCM channels, front and back detectors, and MSD.
 - When a detector is selected, the outlet end of the column is controlled at 0 psig for the FID, TCD, FPD+, NPD, and ECD or vacuum for the MSD.
 - If the column exhausts into a nonstandard detector or environment (neither ambient pressure nor complete vacuum), select **Other** and enter the outlet pressure.
- 7 Under Thermal zone, select the desired thermal zone from the dropdown menu.
- 8 Set **In_Segment Length**, **Out_Segment Length**, and **Segment 2 Length** to **0** to disable composite column configuration. See [“To configure a composite column”](#) for information.
- 9 Select **Apply**. This saves the changes to the GC.

To configure a composite column

A composite column is a capillary column that passes through multiple heating zones. A composite column consists of a main segment and one or more additional segments. There may be one segment on the input side of the main segment (**In Segment**) and up to two segments on its output side (**Out Segment**, **Segment 2**). Each of the four segments' lengths,

diameters, and film thicknesses can be specified separately. Also, the zones that determine the temperatures of each of the four segments are specified separately. The three additional segments are often uncoated (zero film thickness) and, serving as connectors, are of shorter length than the main segment. It is necessary to specify these additional segments so that the flow-pressure relationship for the composite column can be determined.

Composite columns differ from multiple columns because for composite columns, 100% of the column flow continues through a single column or through multiple column segments without additional makeup gas.

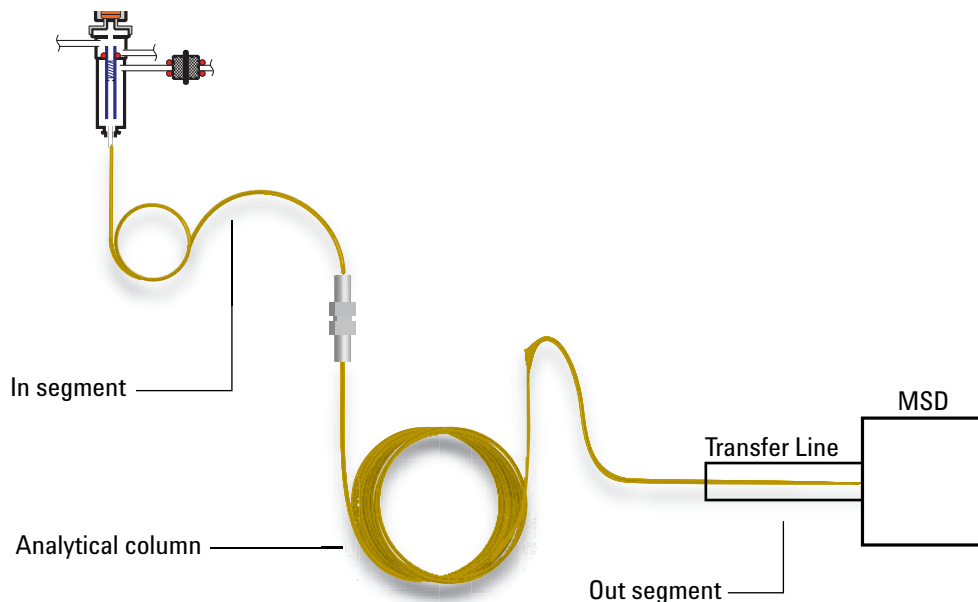

To configure a composite column:

- 1 Select **Settings > Configuration > Columns**.
- 2 Under Column Type, select **Composite** from the dropdown menu.
- 3 Input the Length, Diameter, and Film Thickness into the appropriate fields.
- 4 Under Inlet connection, select the desired inlet from the dropdown menu. Selections include the installed GC inlets, and installed Aux and PCM channels.
- 5 Under Outlet connection, select the desired outlet from the dropdown menu.
- 6 Under Thermal zone, select the desired thermal zone from the dropdown menu.
- 7 Select the down arrow on the right side of the window to view additional settings.
- 8 In the second screen, set the Length, Diameter, and Film Thickness for each segment.
- 9 In the Heated By column, select the heating source for each column segment from the dropdowns.
- 10 In the third screen, set the Min Temp, Max Temp, and Max Program Temp for your column.
- 11 In the fourth screen, you can set the column's
 - Manufacturer

- Date Manufactured
- Serial Number
- Part Number
- Phase Tag
- Column ID Lock. If using an optional barcode scanner, this will be set to **Locked** by the data system. Normally, set to **Unlocked** when not using a barcode scanner.

12 Select **Apply**. This saves the changes to the GC.

Additional notes on column configuration

You should check configurations for all columns to verify that they specify the correct pressure control device at each end. The GC uses this information to determine the flow path of the carrier gas. Only configure columns that are in current use in your GC's carrier gas flow path. Unused columns configured with the same pressure control device as a column in the current flow path cause incorrect flow results.

It is possible, and sometimes appropriate, to configure both installed columns to the same inlet.

When splitters or unions exist in the carrier gas flow path, without a GC's pressure control device monitoring the common junction point, the individual column flows cannot be controlled directly by the GC. The GC can only control the inlet pressure of the upstream column whose inlet end is attached to a GC's pressure control device. A column flow calculator available from Agilent, and provided with Agilent capillary flow devices, is used for determining pressures and flows at this type of junction.

Some pneumatic setpoints change with oven temperature because of changes in gas viscosity. This may confuse users who observe pneumatics setpoints changing when their oven temperature changes. However, the flow condition in the column remains as specified by the column mode (constant flow or pressure, ramped flow or pressure) and the initial setpoint values.

To configure multiple columns

To configure multiple columns, repeat the procedure above for each column.

These are the available choices for **Inlet**, **Outlet**, and **Thermal zone**. Some will not appear on your GC if the specific hardware is not installed.

Table 16 Choices for column configuration

Inlet	Outlet	Thermal zone
Front inlet	Front detector	GC oven
Back inlet	Back detector	Auxiliary oven
Aux# 1 through 9	MSD	Aux thermal zone 1
PCM A, B, and C	Aux detector 1	Aux thermal zone 2
Aux PCM A, B, and C	Aux detector 2	Aux thermal zone 3

Table 16 Choices for column configuration (continued)

Inlet	Outlet	Thermal zone
Unspecified	PCM A, B, and C	
PSD	Aux PCM A, B, and C	
	Front inlet	
	Back inlet	
	PSD	
	Other	

Inlets and outlets

The pressure control devices at the inlet and outlet ends of a column, or series of columns in a flow path, control its gas flow. The pressure control device is physically attached to the column through a connection to a GC inlet, a valve, a splitter, a union, or other device.

Table 17 Column inlet end

If the column gas flow source is:	Choose:
An inlet (SS, PP, COC, MMI, PTV, VI, or other) with electronic pressure control	The inlet.
A valve, such as gas sampling	The auxiliary (Aux PCM) or pneumatics (PCM) control module channel that provides gas flow during the inject cycle.
A splitter with an EPC makeup gas supply	The Aux PCM or EPC channel that provides the makeup gas
A device with a manual pressure controller	Unknown

Similar considerations apply for the column outlet end. When a column exits to a splitter, select the GC's pressure control source attached to the same splitter.

Table 18 Column outlet end

If the column exhausts into	Choose:
A detector	The detector.
A splitter with a makeup gas supply	The Aux PCM or EPC channel that provides makeup gas flow to the splitter.
A device with a manual pressure controller	Unknown

A simple example

An analytical column is attached at its inlet end to a split/splitless inlet located at the front of the GC and the column outlet is attached to an FID located at the front detector position.

Table 19 Analytical column

Column	Inlet	Outlet	Thermal zone
Analytical column	Front split/splitless	Front FID	GC oven

Since only a single column is configured, the GC determines that it controls the inlet pressure to the column by setting the front inlet pressure and the outlet pressure is always atmospheric. The GC can calculate a pressure for the front inlet that can exactly overcome the resistance to flow presented by this column at any point during a run.

Slightly more complex example

A precolumn is followed by a AUX 1 pressure controlled splitter and two analytical columns. This requires three column descriptions.

Table 20 Precolumn split to two analytical columns

Column	Inlet	Outlet	Thermal zone
1 - Precolumn	Front inlet	AUX 1	GC oven
2 - Analytical column	AUX 1	Front detector	GC oven
3 - Analytical column	AUX 1	Back detector	GC oven

The GC can calculate the flow through the precolumn using the precolumn's physical properties to calculate the column's resistance to flow, along with the front inlet pressure and the AUX 1 pressure. Your analytical method can set this flow directly for the precolumn.

For the flow in the two parallel analytical columns 1 and 2, the GC can use the column's physical properties to calculate the split flow through each individual column, at a given AUX 1 pressure, with both columns exiting to atmospheric pressure. Your analytical method can only set the flow/pressure for the lowest numbered column in the split, in this case, Analytical column #2. If you try to set the flow for column #3, it will be ignored and the flow for column #2 will be used.

If other columns are currently defined, they may not use AUX 1, Front inlet, Front detector, or Back detector in their configuration.

Oven

Readiness When enabled, the GC will not become ready until the oven reaches its setpoints.

Oven Standby When enabled, the oven temperature changes to the specified Temperature after the GC has been idle for the entered Time. A usage example would be to set the standby temperature to a relatively high value to keep the system clean between runs (reduce carryover) when the GC may sit idle for long periods.

Maximum temperature Sets an upper limit to the oven temperature. Used to prevent accidental damage to columns. The range is 70 to 450 °C. See the column manufacturer's recommendations.

Cryo These setpoints control liquid carbon dioxide (CO₂) or liquid nitrogen (N₂) cooling of the oven.

The cryogenic valve lets you operate the oven below ambient temperature. Minimum attainable oven temperature depends on the type of valve installed.

The GC senses the presence and type of cryogenic valve and disallows setpoints if no valve is installed. When cryogenic cooling is not needed or cryogenic coolant is not available, the cryogenic operation should be turned off. If this is not done, proper oven temperature control may not be possible, particularly at temperatures near ambient.

External Oven Isothermal internal oven and programmed external oven used to calculate column flow.

Slow Cool Down Mode On reduces the oven fan speed during the cool down cycle.

Limit Ballistic Power Reduce oven power when heating at maximum rate to limit the current drawn from the power line.

To configure the oven

- 1 Select **Settings > Configuration > Oven**.
- 2 Use the oven configuration window to set the **Maximum Temperature**, **Limit Ballistic Power**, and set the **Oven Standby**.

NOTE

If the GC uses cryogenic cooling, it automatically configures the coolant type.

- 3 Select **Apply**. The entered changes are saved to the GC.

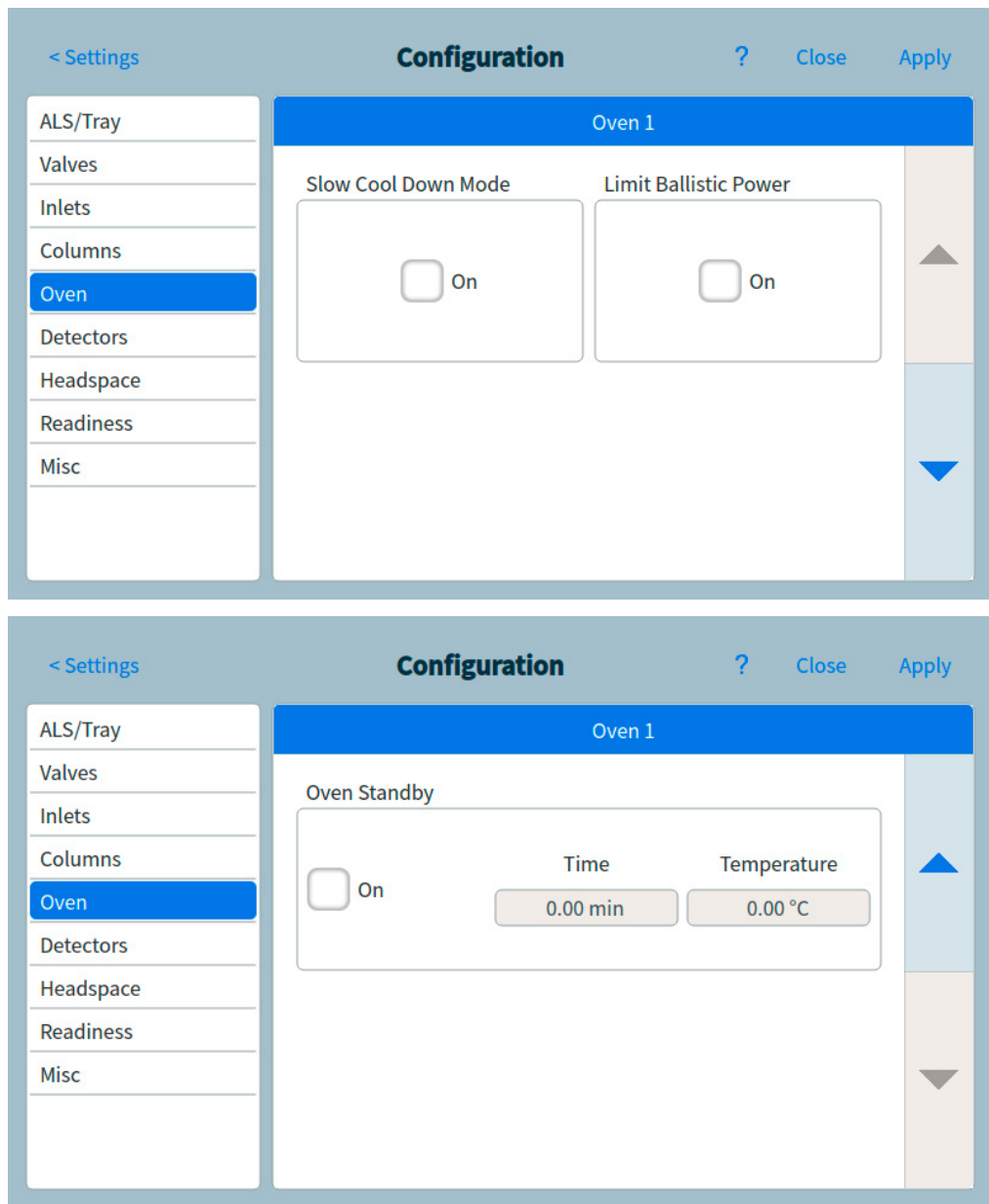

Figure 56. Configuring the oven

Detector Configuration

If you are operating with column defined, you have a choice of two makeup gas modes. To set the makeup gas for a detector:

- 1 Select **Settings > Configuration > Detectors**, then select the tab for the detector to configure. See **Figure 57**.

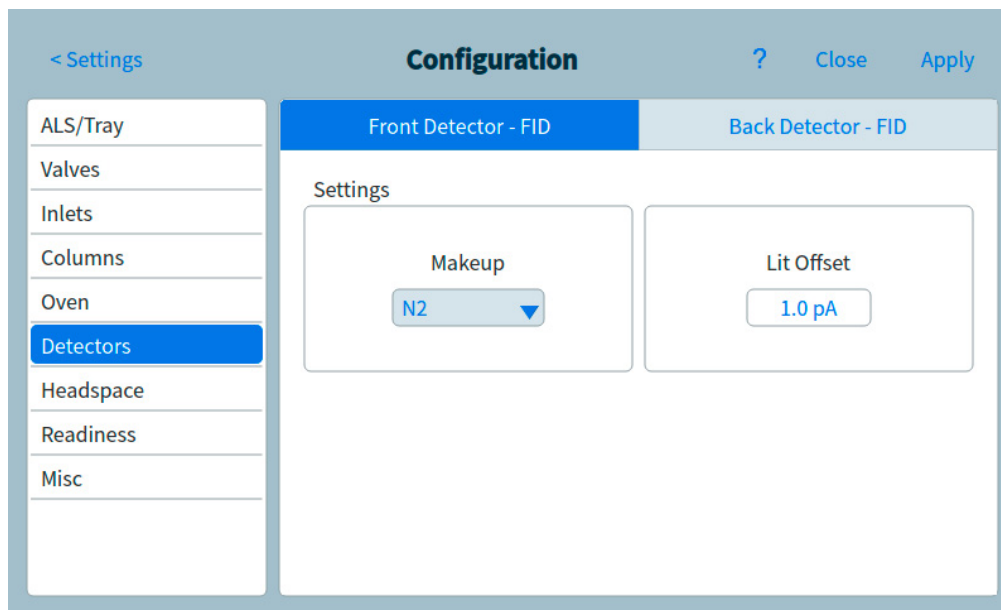

Figure 57. Detectors page

- 2 If available, select the makeup gas type that is plumbed to the detector. Depending on your detector type and the carrier gas selection, the gas type may be already set for you.
- 3 Make or enter settings for the detector, as applicable:
 - **Lit Offset.** FID and FPD+. See **“Detectors”**.
 - **Readiness.** Enable if using this detector. When disabled, the GC becomes ready even if this device has not reached or cannot reach its setpoints.
 - **Target Offset.** NPD only. Enter the default target offset. The GC will slowly try to reach this target value after the detector flows are read, the temperature is stable, and the dry bead time has elapsed.
- 4 Select **Apply**. The entered changes are saved to the GC.

Analog Output Settings

When connecting the GC to an integrator or recorder, the device must be fast enough to process data coming from the GC. If it cannot keep up with the GC, the data may be incorrect or corrupted. This usually shows up as broadened peaks and loss of resolution.

Speed is measured in terms of bandwidth. The recorder or integrator should have a bandwidth twice that of the signal being measured.

The GC can operate at two speeds. The faster speed allows minimum peak widths of 0.004 minutes (8 Hz bandwidth), while the standard speed allows minimum peak widths of 0.01 minutes (1.6 Hz bandwidth).

If using fast peaks feature, the integrator should operate at approximately 15 Hz.

NOTE

Agilent does not recommend using Fast peaks with a TCD detector. Since the gas streams switch at 5 Hz, the gain in peak width is offset by increased noise.

To change the analog output settings:

- 1 Select **Method** > **Analog Out**, and then select either **Analog Out 1** or **Analog Out 2**.

	Analog Out 1	Analog Out 2
Signal	Signal Type: Front Detector Value: 0 mV	Settings: Fast Peaks (unchecked) Range: 0
Zero	On (checked) Setpoint: 0 pA	

Figure 58. Analog output settings page

- 2 To use fast peaks for either analog output channel, select the corresponding **Fast Peaks** check box.

MSD Configuration

System-level communications

When the GC and other Agilent instruments that support enhanced communications, such as an MS or HS, are configured together, they communicate with and react to each other. The instruments share events and data to provide interaction and efficiency. As the state of one instrument changes, the other instruments react accordingly. For example if you start to vent an MS, the GC automatically changes flows and temperatures. If the GC enters its "sleep" state to conserve resources, so do the MS and HS. When programming the HS, the HS automatically incorporates the current GC method setpoints to calculate timing and throughput.

One of the primary advantages of enhanced communications is that instruments can protect themselves and each other from damage. Events that cause this type of interaction include:

- GC shutdowns
- MS venting
- MS shutdowns

Another advantage of enhanced communications is the convenience provided at a system level:

- Consolidated EMF tracking
- Synchronized instrument clocks (requires an Agilent data system)
- Synchronized instrument schedules (sleep/wake)
- Pass-through display of connected instrument errors to the GC display

MSD configuration

The method for configuring a connected MSD varies based on the model of MSD being used.

5977B GC/MSD

The 5977B connects to the GC via an LVDS cable to one of the ELVDS communication ports on the rear of the GC. Because of this, the GC treats the MSD as a detector. No communication configuration is necessary.

To change the MSD settings:

- 1 Select **Settings > Configuration > Detectors**. See **Figure 59**.

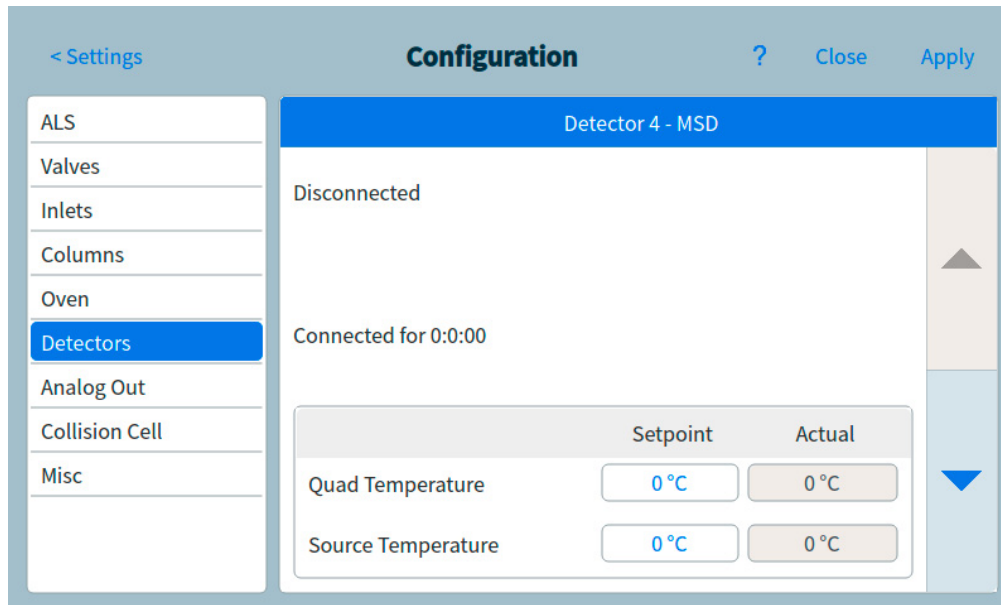

Figure 59. Detector MSD settings page

- 2 Select **LCOMM** from the dropdown menu under Connection Type.
- 3 Enter details for, and control, the MSD. This includes temperature setpoints, communication settings, MSD information and initiating venting, pump downs, and reboots.
- 4 Select **Apply**. The entered changes are saved to the GC.

5975, 5977A, 7000A/B/C/D, 7010A/B GC/MS, 7250 GC/QTOF

These devices connect to the GC via a LAN cable either to the LAN cable on the rear of the GC or to the GC via the laboratory network. To change the settings:

- 1 Select **Settings > Configuration > Detectors**. See **Figure 59**.
- 2 Select **DCOMM** from the dropdown menu under Connection Type.
- 3 Enter details for, and control, the MSD. This includes temperature setpoints, communication settings, MSD information and initiating venting, pump downs, and reboots.
- 4 Select **Apply**. The entered changes are saved to the GC.

GC/MS systems

This section describes GC behaviors and features that require an MS or MSD that supports enhanced GC-MS communications. (Refer to the MS documentation for details.)

Venting the MS

When you use the MS keypad to initiate fast venting, or when you use the Agilent data system to start venting, the MS alerts the GC. The GC loads the special MS Vent method. The GC keeps the MS Vent method loaded until:

- The MS becomes ready again.
- You manually clear the MS Vent state.

During the venting process the MS will notify the GC that venting is complete. The GC will then set very low flows at each flow- or pressure-controlled device leading back through the column configuration chain to the inlet. For example, for a configuration that uses a purged union at the transfer line, the GC will set the pressure at the purged union to 1.0 psi, and the pressure at the inlet to 1.25 psi.

If using hydrogen carrier gas, the GC will simply turn the gas off to prevent hydrogen accumulation in the MS.

Note that while in the MS Vent state, the GC will not go into MS Shutdown after losing communications with the MS.

MS Shutdown events

When configured with an MS or MSD that supports enhanced GC-MS communications, the following events will cause an MS Shutdown in the GC:

- Loss of communications with the MS, when not venting the MS. (Requires no communications for a length of time.)
- MS reports a high vacuum pump failure.

When the GC enters an MS shutdown:

- The GC aborts any current run.
- The oven is set to 50 °C. When it reaches that setpoint, it turns off.
- The MS transfer line temperature is turned off.
- If using a flammable carrier gas, the gas is turned off after the oven cools (for the MS column flow path only).
- If not using a flammable carrier gas, the GC will set very low flows at each flow- or pressure-controlled device leading back through the column configuration chain to the inlet. For example, for a configuration that uses a purged union at the transfer line, the GC will set the pressure at the purged union to 1.0 psi, and the pressure at the inlet to 1.25 psi.
- The GC displays the error state and notes the events in the logs.

The GC will not be usable until the error state is cleared or until the MS is unconfigured from the GC. See **"To use the GC when the MS is shut down"**.

If the MS is repaired or clears its error, or if communications are restored, the GC will automatically clear this error state.

GC Pressure Shutdown events

If the GC goes into a pressure shutdown for the carrier gas going to the MS transfer line, the MS will log this event. As part of the shutdown steps, the GC will also turn off the MS transfer line. (See the GC *Troubleshooting* manual for more information about GC shutdown behaviors.)

To Set Up a Vent Method

A good MS Vent method does the following:

- Turns off the MS transfer line heater.

- Turns off the inlet heater.
- Sets the oven to a low temperature, < 50 °C, for fast cool down.
- Sets the column flow rate into the MS to as high a flow as you feel is appropriate and safe. For turbo pumps, set the flow to 15 mL/min or to the maximum flow rate possible for the column configuration (note that rates above 15 mL/min may not provide additional benefits). For diffusion pumps, typically set the flow to 2 mL/min (never exceed 4 mL/min).

When you first configure a GC-MS system on an Agilent data system, you will be prompted to create this method if it does not already exist.

You must create this method to use the MS's fast venting feature.

To enable or disable MS communications

To temporarily disable GC-MS communications:

- 1 Select **Settings > Configuration > Detectors**.
- 2 Scroll until the Enable Communication checkbox is visible.
- 3 Select or deselect the checkbox next to **Enable Communication** to enable or disable communication with the MS.

To use the GC when the MS is shut down

To use the GC while an MS is being repaired or maintained, do the following:

Be careful to avoid settings that send carrier gas into the MS, or which raise the temperature of parts which might cause burns when working on the MS.

- 1 Disable MS communications. See [“To enable or disable MS communications”](#).
- 2 If needed, completely uninstall the MS from the GC.

Headspace Sampler

Headspace sampler configuration

The 7697A headspace sampler is supported by the GC. The headspace sampler connects to the GC via a LAN cable either to the LAN port on the rear of the GC, or to the GC via the laboratory network. To change the settings:

- 1 Select **Settings** > **Configuration** > **Headspace**. See **Figure 60**.

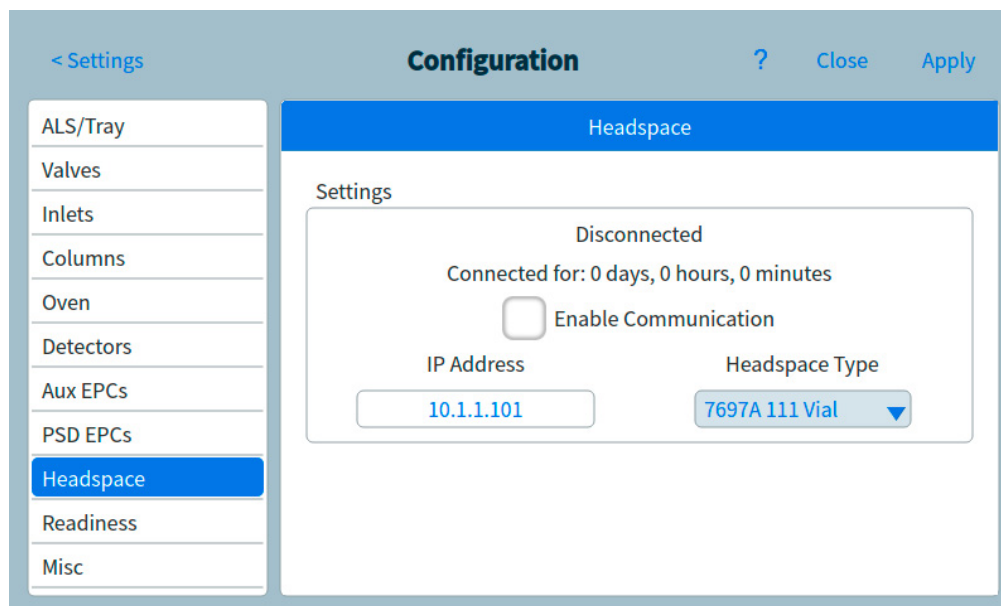

Figure 60. Headspace settings page

- 2 Use this page to enter details for, and control, the headspace sampler.
- 3 Select **Apply**. The entered changes are saved to the GC.

System-Level communications

When the GC and other Agilent instruments that support enhanced communications, such as an MS or HS, are configured together, they communicate with and react to each other. The instruments share events and data to provide interaction and efficiency. As the state of one instrument changes, the other instruments react accordingly. For example if you start to vent an MS, the GC automatically changes flows and temperatures. If the GC enters its "sleep" state to conserve resources, so do the MS and HS. When programming the HS, the HS automatically incorporates the current GC method setpoints to calculate timing and throughput.

One of the primary advantages of enhanced communications is that instruments can protect themselves and each other from damage. Events that cause this type of interaction include:

- GC shutdowns
- MS venting
- MS shutdowns

Another advantage of enhanced communications is the convenience provided at a system level:

- Consolidated EMF tracking
- Synchronized instrument clocks (requires Agilent data system)
- Synchronized instrument schedules (sleep/wake)
- Pass-through display of connected instrument errors to the GC display

See the *Installation and First Startup* manual for configuration details.

To enable or disable HS communications

To temporarily disable GC-HS communications:

- 1 Select **Settings > Configuration > Headspace**.
- 2 Use the down arrow to scroll until the Enable Communication checkbox is visible.
- 3 Select or deselect the checkbox next to **Enable Communication** to enable or disable communication with the headspace.

Miscellaneous Settings

The GC provides the option to change the pressure units displayed by the GC. To change the displayed pressure units:

- 1 Select **Settings** > **Configuration** > **Misc**. See **Figure 61**.

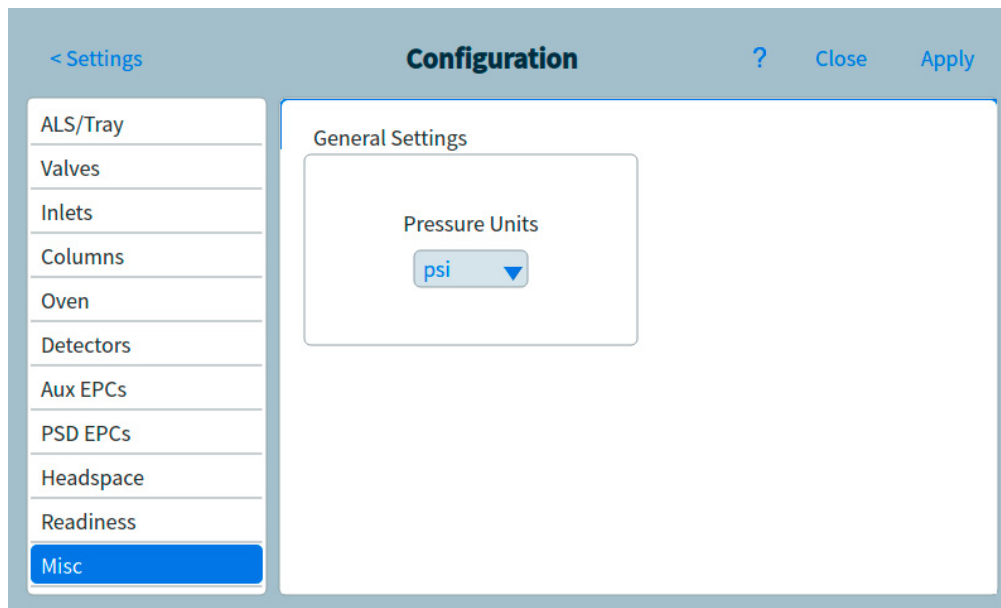

Figure 61. Miscellaneous settings page

- 2 Select the desired units type from the **Pressure Units** list.
 - **psi**—pounds per square inch, lb/in²
 - **bar**—absolute cgs unit of pressure, dyne/cm²
 - **kPa**—mks unit of pressure, 10³ N/m²
- 3 Select **Apply**. The entered changes are saved to the GC.

Readiness

The states of the various hardware components are among the factors that determine whether the GC is Ready for analysis.

Under some circumstances, you may not wish to have a specific component's readiness considered in the GC readiness determination. This parameter lets you make that choice. The following components allow readiness to be ignored: inlets, detectors, the oven, and PCM.

For example, suppose an inlet heater is defective but you don't plan to use that inlet today. By deselecting the **Enable** checkbox under **Readiness** for that inlet, you can use the rest of the GC. After the heater is repaired, reselect the checkbox or the run could start before that inlet's conditions are ready.

To ignore a component's readiness, tap **Settings > Configuration**, then select the component. Scroll down until the **Readiness** field is visible, then tap the **Enable** checkbox to remove its checkmark.

To re-enable a component's readiness, tap **Settings > Configuration**, then select the component. Scroll down until the **Readiness** field is visible, then tap the **Enable** checkbox to restore its checkmark.

LTM Columns

Low Thermal Mass (LTM) controllers and columns mount on the front door of the GC.

Configure an LTM series II column module as a composite column. When using using a LTM Series II column module, the GC obtains the following parameters from the column module itself during startup: primary column dimensions (length, id, film thickness, and basket size), and column maximum and absolute maximum temperatures.

Configure the column type, the In and Out segment dimensions, and so forth as needed.

Note that LTM columns can be edited only for certain parameters: column length (within a small percentage, for calibration purposes) and id (within a small percentage). Since the LTM Series II column module contains its column information, and since the column type is not changeable, changing other dimensions (for example, film thickness) does not apply.

See **“To configure a composite column”**.

Valve Box

The valve box mounts on top of the column oven. It may contain up to six valves mounted on heated blocks. Each block can accommodate two valves.

Valve positions on the blocks are numbered. We suggest that valves be installed in the blocks in numeric order.

All heated valves in a valve box are controlled by the same temperature setpoint.

To Configure a Valve:

- 1 Select **Settings > Configuration > Valves**.
- 2 For each valve installed, select the valve type, then set the loop volume, step time, and BCD inversion as applicable to the valve type.
- 3 Click **Apply** to store the changes.

PCMs

A pressure control module (PCM) provides two channels of gas control.

To configure a PCM:

- 1 Select **Settings > Configuration > PCMs**.
- 2 Select the PCMs Aux Mode:
 - Forward Pressure: Pressure is being sensed downstream from the flow proportional valve.
 - Back pressure: Pressure is being sensed upstream from the flow proportional valve.
- 3 Select the Gas Type for channel 1, the forward-pressure control channel.
- 4 Select the Gas Type for the auxiliary channel (channel 2).

Channel 1 of the PCM provides forward pressure or forward flow control. It can be used to provide column flow or pressure for valved systems, sample preparation devices, or advanced flow devices like splitters or switches.

Channel 2, or the auxiliary channel, can only provide forward pressure regulation when plumbed normally, or back pressure regulation when reversed. Thus, channel 2 (reversed) can be used as a controlled leak. If the input pressure drops below setpoint, the regulator can close down to restore it. If the input pressure rises above setpoint, the regulator can open to restore it.

Aux EPCs

An auxiliary pressure controller provides three channels of forward-pressure regulation. Three modules can be installed for a total of nine channels.

The numbering of the channels depends on where the controller is installed. Within a single module, channels are numbered and labeled.

To configure an Aux EPC:

- 1 Select **Settings > Configuration > Aux EPCs**.
- 2 For each channel, select the Gas Type.

Resource Conservation	190
Sleep methods	190
Wake and condition methods	191
To Set the GC to Conserve Resources	193

This section describes the resource-saving features of the GC. When used with other instruments configured for enhanced communications, additional features become available for the GC-MS, GC-HS, or HS-GC-MS system.

Resource Conservation

The GC provides an instrument schedule to conserve resources such as electricity and gases. Using the instrument schedule, you can assign sleep, wake, and conditioning methods that allow you to program resource usage. A Sleep method sets low flows and temperatures. A Wake method sets new flows and temperatures, typically to restore operating conditions. A Condition method sets flows and temperatures for a specific run time, typically high enough to clean out contamination if present.

Load the sleep method at a specified time during the day to reduce flows and temperatures. Load the wake or condition method to restore analytical settings before operating the GC again. For example, load the sleep method at the end of each day or work week, then load the wake or condition method an hour or so before arriving to work the next day.

Sleep methods

Use a connected data system to create a sleep method to reduce gas and power usage during times of reduced activity.

When creating a sleep method, consider the following:

- The detector. While you can reduce temperatures and gas usage, consider the stabilization time required to prepare the detector for use. The power savings is minimal.
- Connected devices. If connected to an external device such as a mass spectrometer, set compatible flows and temperatures.
- The inlets. Maintain sufficient flow to prevent contamination.
- **Cryo cooling.** Devices which use cryo cooling may start immediately using cryogen if the wake method requires it.

See **Table 21** for general recommendations.

Table 21 Sleep method recommendations

GC Component	Comment
Columns	<ul style="list-style-type: none"> • Maintain some carrier gas flow to protect the columns.
Oven	<ul style="list-style-type: none"> • Reduce temperature to save power. • Turn off to save the most power.
Inlets	For all inlets: <ul style="list-style-type: none"> • Reduce temperatures. Reduce temperatures to 40 °C or Off to save the most power.
Split/splitless	<ul style="list-style-type: none"> • Use split mode to prevent diffusion of contamination from the vent line. Use reduced split ratio. • Reduce pressure. Consider using current Gas Saver levels, if used.
Multimode	<ul style="list-style-type: none"> • Use split mode to prevent diffusion of contamination from the vent line. Use reduced split ratio. • Reduce pressure. Consider using current Gas Saver levels, if used. • Reduce temperature.
PTV	<ul style="list-style-type: none"> • Use split mode to prevent diffusion of contamination from the vent line. Use reduced split ratio. • Reduce pressure. Consider using current Gas Saver levels, if used. • Reduce temperature.
VI	<ul style="list-style-type: none"> • Use split mode to prevent diffusion of contamination from the vent line. Use reduced split ratio. • Reduce pressure. Consider using current Gas Saver levels, if used.

Table 21 Sleep method recommendations (continued)

GC Component	Comment
PP	<ul style="list-style-type: none"> Reduce temperature.
Detectors	
FID	<ul style="list-style-type: none"> Turn off the flame. (This turns off hydrogen and air flows.) Reduce temperatures. (Keep at or above 150 °C to reduce contamination) Turn off makeup flow.
FPD+	<ul style="list-style-type: none"> Turn off the flame. (This turns off hydrogen and air flows.) Reduce temperatures. <ul style="list-style-type: none"> Leave emission block at 125-175 °C. Reduce transfer line to 150 °C. Turn off makeup flow.
ECD	<ul style="list-style-type: none"> Reduce makeup flow. Try using 15–20 mL/min and test results. Maintain temperature to avoid long recovery/stabilization times.
NPD	<ul style="list-style-type: none"> Maintain flows and temperatures. Sleep not recommended due to recovery times and also thermal cycling can reduce bead life.
TCD	<ul style="list-style-type: none"> Leave filament on. Leave block temperature on. Reduce reference and makeup flows.
Other devices	
Valve box	<ul style="list-style-type: none"> Reduce temperature. (Keep valve box temperature high enough to prevent sample condensation, if applicable.)
Aux thermal zones	<ul style="list-style-type: none"> Reduce or turn off. Also refer to the manuals for any connected device (for example, a connected MSD).
Aux pressures or flows	<ul style="list-style-type: none"> Reduce or turn off as appropriate for connected columns, transfer lines, and so forth. Always refer to the manual for any connected device or instrument (for example, a connected MSD), to maintain at least the minimum recommended flows or pressures.

Wake and condition methods

The GC can be programmed to wake in one of several ways:

- By loading the last Active Method used before going to sleep
- By loading the **Wake** method
- By running a method called **Condition**, then loading the last Active Method
- By running a method called **Condition**, then loading the **Wake** method

NOTE

The GC can also store wake, sleep, and condition methods which have been created by a connected data system. Although these methods are not visually displayed on the GC, once downloaded to the GC from the data system, they can be used by the GC scheduler functionality.

These choices provide flexibility in how you prepare the GC after a sleep cycle.

A **Wake method** sets a temperatures and flows. The oven temperature program is isothermal since the GC does not start a run. When the GC loads a **Wake** method, it remains at those settings until you load another method using the touchscreen, data system, or by starting a sequence.

A **Wake** method can include any settings, however it typically will do the following:

- Restore inlet, detector, column, and transfer line flows.
- Restore temperatures.
- Ignite the FID or FPD+ flame.
- Restore inlet modes.

A **Condition method** sets flows and temperatures for the duration of the method's oven program. When the program ends, the GC loads either the **Wake** method or the last Active Method before sleep, as specified in the instrument schedule (or when manually exiting the sleep state).

One possible use for a condition method is to set higher than normal temperatures and flows to bake out any possible contamination that may have collected in the GC during sleep.

To Set the GC to Conserve Resources

To set the GC to conserve resources by creating and using an **Instrument Schedule**:
Select the **Settings** tab. See **Figure 62**.

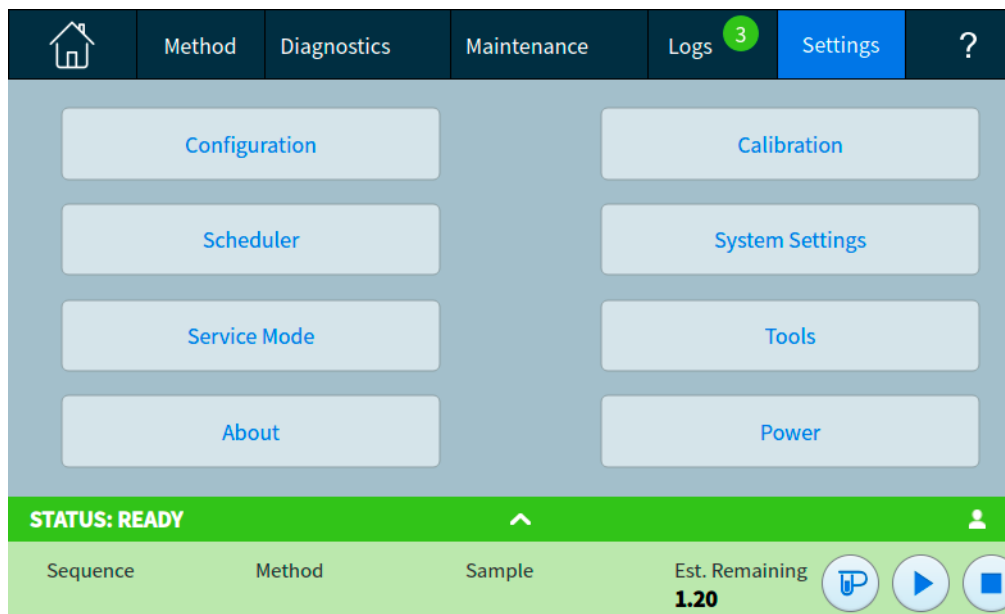

Figure 62. Settings view

- 1 Select **Scheduler**. The Instrument Schedule page appears. See **Figure 63**.

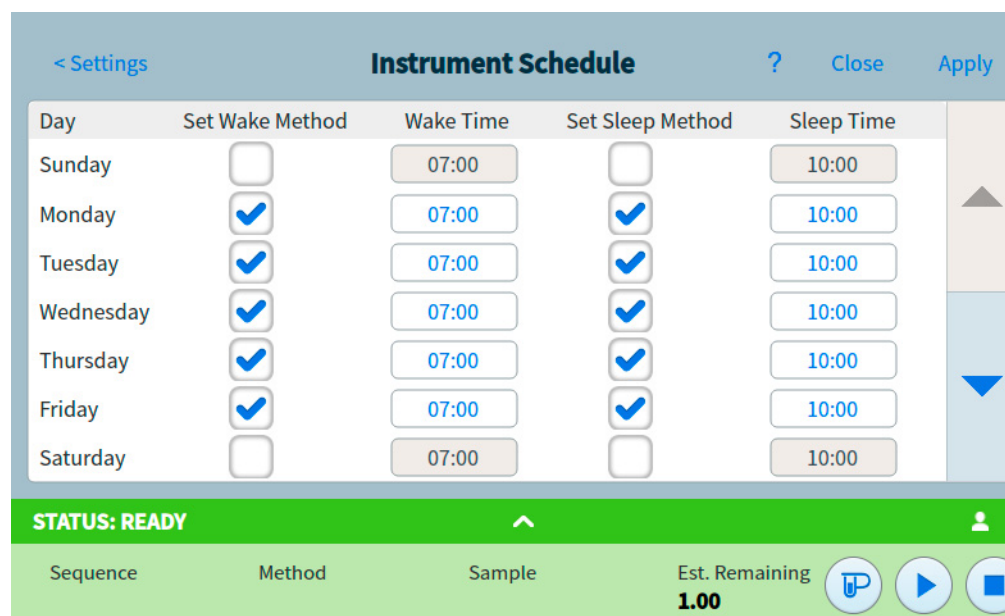

Figure 63. Instrument Schedule page

- 2 Create the **Instrument Schedule**. You do not have to program events for every day. For example, you can program the GC to sleep on Friday evening, then wake on Monday morning, keeping it continuously at operating conditions during weekdays.
 - a Enter a **Wake Time** for each desired day. Use the corresponding drop-down list box to specify **AM** or **PM**.
 - b Enter a **Sleep Time** for each desired day. Use the corresponding drop-down list box to specify **AM** or **PM**.
 - c Choose **Set Wake Method** for each desired day, as applicable. This will cause the Wake method to be run when the GC wakes on the selected days. See **“Wake and condition methods”**.
 - d Choose **Set Sleep Method** for each desired day, as applicable. This will cause the Sleep method to be run prior to the GC going to sleep on the selected days. See **“Sleep methods”**.
- 3 Scroll to the Scheduler Options area. See **Figure 64**.

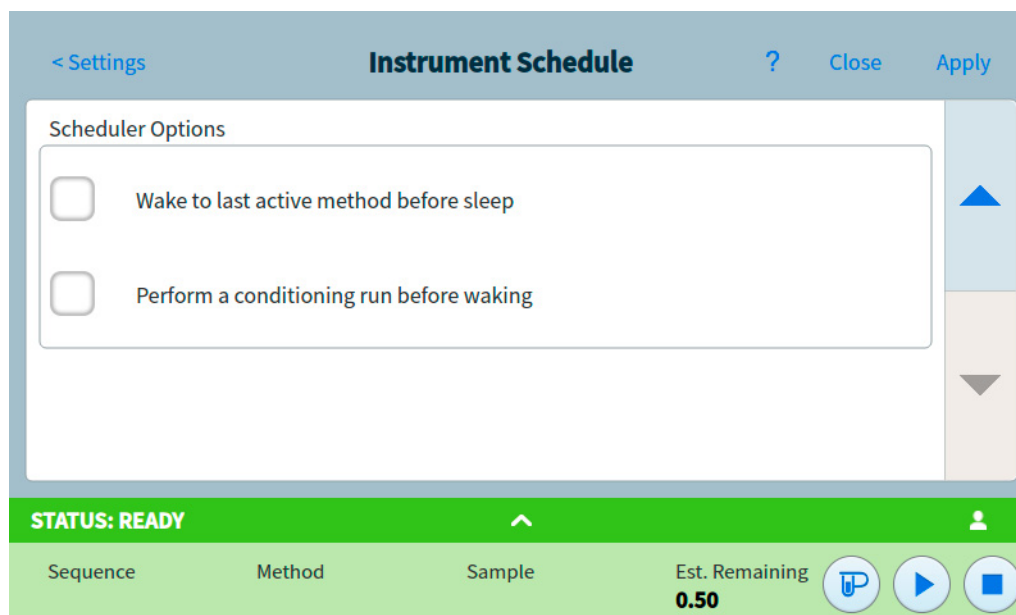

Figure 64. Scheduler Options area

- 4 Decide how to restore flows. Choose the desired options:
 - **Wake to last active method before sleep:** At the specified time, the GC will restore the last Active Method used before it went to sleep.
 - **Perform a conditioning run before waking:** At the specified time, the GC will load the condition method. This method runs once. See **“Wake and condition methods”**.
- 5 Select **Apply**. The settings are saved to the GC.

Clock Time Programming	196
Using clock time events	196
Adding events to the clock table	196
Deleting clock time events	196

Clock Time Programming

Clock time programming allows certain setpoints to change automatically at a specified time during a 24-hour day. Thus, an event programmed to occur at 14:35 hours will occur at 2:35 in the afternoon. A running analysis or sequence has precedence over any clock table events occurring during this time. When this happens, such events are not executed.

Possible clock time events include:

- Valve control
- Method and sequence loading
- Starting sequences
- Initiating blank and prep runs
- Column compensation changes
- Adjustments of the detector offset
- Initiating blank and prep runs

Using clock time events

The Clock Table function allows you to program events to occur during a day based on the 24-hour clock. Clock table events that would occur during a run or sequence are ignored.

For example, the clock table could be used to make a blank run before you even get to work in the morning.

Adding events to the clock table

- 1 Select **Settings** on the touchscreen.
- 2 Select **Scheduler** in the left column of options.
- 3 Select the down arrow on the right side to view the clock table.
- 4 Select **+Add**.
- 5 Choose your Clock Type and Frequency from their respective dropdown menus.
- 6 Set the Time you want this event to occur at.
- 7 Select **Add** to add this entry to the clock table.
- 8 Repeat this process until all entries are added.

Deleting clock time events

- 1 Select **Settings** on the touchscreen.
- 2 Select **Scheduler** in the left column of options.
- 3 Select the down arrow on the right side to view the clock table.
- 4 Select the **X** to the right of the desired event. You will be asked to confirm the deletion.
- 5 Select **Yes** to delete the event.

About Flow and Pressure Control 198

Maximum Operating Pressure 199

Auxiliary Pressure Controllers 200

Restrictors 201

 Selecting a frit 202

Example: Using the PCM Channels 203

PIDs 204

About Flow and Pressure Control

The GC uses five types of electronic flow or pressure controllers; inlet modules, detector modules, pressure control modules (PCMs), auxiliary pressure controllers (Aux EPCs), and pneumatic switching devices (PSDs).

All of these modules mount in the slots at the top rear of the GC. The slots are identified by numbers, as shown here.

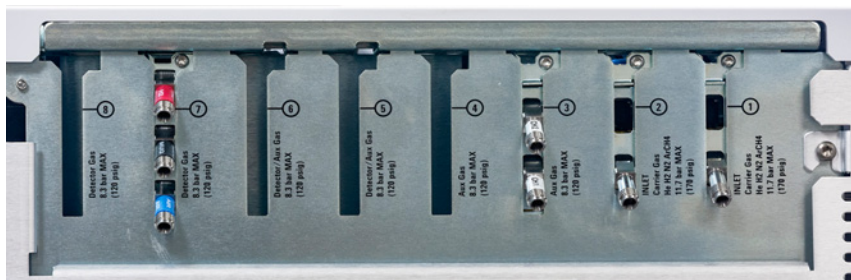

Figure 65. EPC module slots

Table 22 EPC Modules

Number	Usage
1	Inlet module
2	Inlet module
3	Aux EPC
4	Aux EPC
5	Detector module/Aux EPC
6	Detector module/Aux EPC
7	Detector module
8	Detector module

Maximum Operating Pressure

We recommend a maximum continuous operating pressure of 170 psi to avoid excessive wear and leaks.

Auxiliary Pressure Controllers

The Auxiliary Pressure Controller (Aux epc) is also a general purpose device. It has three independent forward-pressure regulated channels. Channels are designated by numbers 1 through 9 (there can be up to 3 Aux epcs), depending on where the module is installed.

Restrictors

The Aux EPC and aux PCM channel use frit-type restrictors to allow accurate flow control. To work properly, there must be adequate flow resistance downstream of the pressure sensor. Each channel provides a frit-type restrictor. Four frits are available.

Table 23 Auxiliary channel frits

Frit marking	Flow resistance	Flow characteristic	Often used with
Three rings Blue	High	3.33 ± 0.3 SCCM @ 15 PSIG	NPD Hydrogen
Two rings Red	Medium	30 ± 1.5 SCCM H ₂ @ 15 PSIG	FID Hydrogen
One ring Brown	Low	400 ± 30 SCCM AIR @ 40 PSIG	FID Air, FPD+ Air, QuickSwap, Splitter, Deans Switch
None (brass tube)	Zero	No restriction	Headspace vial pressurization

The one ring frit (low resistance, high flow) is installed in all channels in the AUX EPC when the instrument (or accessory) is shipped. No frit ships in the PCM Aux channel.

When installing or replacing a frit, always use a new O-ring (5180-4181, 12/pk).

Selecting a frit

The frits change the control range of the channels. The objective is to find a frit that allows the required range of flows at reasonable source pressures.

- For an auxiliary channel ordered as an option (part of the GC order), use the frit supplied by the factory.
- For an auxiliary channel ordered as an accessory (separate from the GC order), see the instruction information supplied with the accessory.
- For a non-Agilent instrument, you must experiment to find the appropriate frit.

When you change a frit, you change the physical characteristics of the channel. It may be desirable (or necessary) to change the PID constants for that channel. See **"PIDs"**.

Example: Using the PCM Channels

The two channels in a PCM are different. Channel 1 is used to *supply* a pressure. Channel 2 may be used in the same way, but can also be used to *maintain* a pressure by reversing the input and output connections.

Channel 1: Forward-pressure

This is identical to the carrier gas channel for the packed column inlet.

Channel 2: Two-way channel

If gas is supplied at the threaded connection and delivered by the tubing, this operates as a forward pressure regulator. But the connections can be reversed—requiring some fittings—so that it will maintain the gas supplied to it at a fixed pressure. In this mode it behaves as a controlled leak.

This can be used to maintain the gas in a gas sampling valve at a fixed pressure, even if the supply varies somewhat. The result is improved reproducibility in sample amount.

The figure shows the connections with the valve in the Load position.

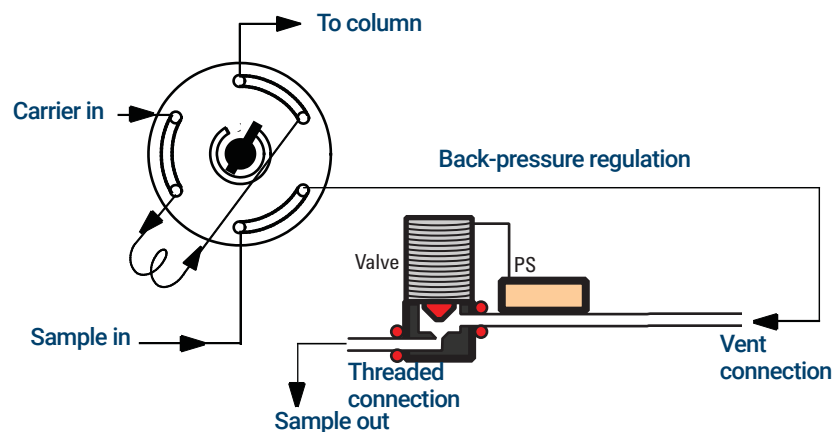

PIDs

The behavior of a pressure control module is governed by a set of three constants, called **P** (proportional), **I** (integral), and **D** (differential).

Certain gases or special applications (such as headspace vial pressurization, flow splitter, and backflush applications) require different PIDs than those provided at the factory.

If you need to update or change the pneumatic PID values for an application, use the utility program on the *GC and GC/MS User Manuals & Tools* DVD provided with the GC.

The table summarizes custom PID values required for selected applications. Note that if you are updating an AUX EPC module, you will need to change the frit for the channel used. See also "**Restrictors.**"

Table 24 PIDs and frits

Application	Module	AUX frit	Select Available PID Values
Purged splitter and Deans Switch when using backflush	AUX EPC	No color or rings	Quickswap
Purged splitter and Deans Switch	AUX EPC	1 ring (or brown dot)	Standard
Headspace vial pressurization	AUX EPC	No color or rings	AUX_EPC_Headspace
Headspace sampling loop	PCM in backpressure control		PCM_Headspace

- Inlet Overview 206
- About the Split/Splitless Inlet 207
 - Selecting the correct S/SL inlet liner 207
- About the Multimode Inlet 209
 - MMI split mode minimum operating pressures 209
 - Selecting the correct MMI liner 210
- About the Purged Packed Column Inlet 212
- About the Cool On-Column Inlet 213
 - Setup modes of the COC inlet 213
 - Retention gaps 213
- About the PTV Inlet 214
 - PTV sampling heads 214
- About the Volatiles Interface 215
 - VI operating modes 215
 - About the VI split mode 216
 - About the VI splitless mode 218
 - About the VI direct mode 221
 - Preparing the Interface for Direct Sample Introduction 224
 - VI direct mode setpoint dependencies 226
 - VI direct mode initial values 226
 - Direct mode parameters 226

Inlet Overview

Table 25 Comparing inlets

Inlet	Column	Mode	Sample concentration	Comments	Sample to column
Split/splitless	Capillary	Split	High		Very little
		Pulsed split	High		Very little
		Splitless	Low		All
		Pulsed splitless	Low		All
Multimode	Capillary	Split	High	Controlled speed injections, concentrate analytes, and vent solvent	Very little
		Pulsed split	High		Very little
		Splitless	Low		All
		Pulsed splitless	Low		All
		Solvent vent	Low		Most
		Direct			All
Purge packed column	Packed Large capillary	n/a	Any	OK if resolution not critical	All
		n/a	Any		All
Cool on-column	Capillary	n/a	Low or labile	Minimal discrimination and decomposition	All
Programmed temperature vaporization	Capillary	Split	High	Controlled speed injections concentrate analytes and vent solvent	Very little
		Pulsed split	High		Very little
		Splitless	Low		All
		Pulsed splitless	Low		All
		Solvent vent	Low		Most
Volatiles interface (for use with external volatiles sampler)	Capillary	Direct	Low	Lowest dead volume Max flow = 100 mL/min	All
		Split	High		Very little
		Splitless	Low		All

About the Split/Splitless Inlet



This inlet is used for split, splitless, pulsed splitless, or pulsed split analyses. You can choose the operating mode from the inlet parameter list. The split mode is generally used for major component analyses, while the splitless mode is used for trace analyses. The pulsed splitless and pulsed split modes are used for the same type of analyses as split or splitless, but allow you to inject larger samples. Sleep mode is used for creating sleep methods, or if all gas needs to flow onto the column.

Selecting the correct S/SL inlet liner

Split liner

A good liner for split mode operation will offer very little restriction to the split flow path between the bottom of the liner and the inlet gold seal and between the outside of the liner and the inside of the injection port body. The preferred Agilent split liner, part number 5183-4647, incorporates a glass positioning bead on the bottom to facilitate this. It also has glass wool inside the liner that provides for complete sample vaporization across the boiling point range of the sample. Select an appropriate liner from **Table 26**.

Table 26 Split mode liners

Liner	Description	Volume	Mode	Deactivated	Part Number
	Low Pressure Drop – Positioning Bead	870 µL	Split – Fast Injection	Yes	5183-4647
	4mm ID, Glass Wool	990 µL	Split – Fast Injection	No	19251-60540
	Low Pressure Drop, Glass Wool	870 µL	Split	Yes	5190-2295

Splitless liner

The liner volume must contain the solvent vapor. The liner should be deactivated to minimize sample breakdown during the splitless time. Solvent vapor volume can be reduced by using Pulsed Splitless mode. Use the Vapor Volume Calculator to determine vapor volume requirements.

Vapor volume < 300 µL Use 2 mm liner (250 µL volume), 5181-8818 or similar.











Vapor volume 225 – 300 µL Consider pulsed splitless mode to reduce vapor volume.

Vapor volume > 300 µL Use 4 mm liner, 5062-3587 or similar.

Vapor volume > 800 µL Consider pulsed splitless mode to reduce vapor volume.

For thermally labile or reactive samples, use G1544-80700 (open top) or G1544-80730 (top taper) liners.

Table 27 Splitless mode liners

Liner	Description	Volume	Mode	Deactivated	Part Number
	Single Taper Glass Wool	900 uL	Splitless	Yes	5062-3587
	Single Taper	900 uL	Splitless	Yes	5181-3316
	Dual Taper	800 uL	Splitless	Yes	5181-3315
	2 mm Quartz	250 uL	Splitless	No	18740-80220
	2 mm Quartz	250 uL	Splitless	Yes	5181-8818
	1.5 mm	140 uL	Direct Inject, Purge and Trap, Headspace	No	18740-80200
	Single Taper Glass Wool	900 uL	Splitless	Yes	5062-3587
	Single Taper	900 uL	Splitless	Yes	5181-3316
	4 mm Single Taper	Direct column connect		Yes	G1544-80730
	4 mm Dual Taper	Direct column connect		Yes	G1544-80700

About the Multimode Inlet

The Agilent Multimode (MMI) Inlet System has seven operating modes:

- The *split mode* is generally used for major component analyses.
- The *pulsed split mode* is like the split mode, but with a pressure pulse applied to the inlet during sample introduction to speed the transfer of material to the column.
- The *splitless mode* is used for trace analyses.
- The *pulsed splitless mode* allows for a pressure pulse during sample introduction.
- The *solvent vent mode* is used for large volume injection. Either single or multiple injections can be made for each run.
- The *direct mode* allows for a direct forward pressure of carrier gas through the column. The split vent valve is closed.
- *Sleep mode* is used for creating sleep methods, or if all gas needs to flow onto the column.

The MMI can be used with both manual and automatic injection.

Automatic multiple injections (large volume injections) is not available under GC control alone.

MMI split mode minimum operating pressures

The minimum recommended inlet total flow is 20 mL/minute. When the inlet is operated in a Split mode, there will be a minimum pressure at which the inlet can operate. Typically, low inlet pressures may be required for shorter, wide bore columns. The minimum pressure is a function of carrier gas type, total inlet flow, liner design, and possible contamination of the split vent tube or trap.

A wide bore column requires a much lower inlet pressure than a typical capillary column to maintain a given flow. Setting the split ratio (total flow) too high when using a wide bore column can create an unstable control relationship between the pressure and flow control loops.

Table 28 Approximate minimum viable inlet pressures for MMI in split mode, in psi (kPa)

	Split vent flow (mL/min)			
	50–100	100–200	200–400	400–600
Split liners - 5183-4647, 19251-60540	2.5 (17.2)	3.5 (24.1)	4.5 (31)	6.0 (41.4)
Splitless liners - 5062-3587, 5181-8818	4.0 (27.6)	5.5 (37.9)	8.0 (55.2)	11.0 (75.4)
Split liners - 19251-60540, 5183-4647	3.0 (20.7)	4.0 (27.6)	—	—
Splitless liners - 5062-3587, 5181-8818	4.0 (27.6)	6.0 (41.4)	—	—





These numbers are based on the resistance to flow of new, clean inlet systems. Sample condensation in the split vent tube or a dirty filter can make these values non-attainable.

Selecting the correct MMI liner

Split liner

A good liner for split mode operation will offer very little restriction to the split flow path between the bottom of the liner and the inlet body and between the outside of the liner and the inside of the inlet body. The preferred Agilent split liner, part number 5183-4647, incorporates a glass positioning bead on the bottom to facilitate this. It will also incorporate glass wool or some other source of surface area inside the liner that provides for complete sample vaporization across the boiling point range of the sample. Select an appropriate liner from [Table 29](#).

Table 29 Split mode liners

Liner	Description	Volume	Mode	Deactivated	Part Number
	Low Pressure Drop – Positioning Bead	870 µL	Split – Fast Injection	Yes	5183-4647
	4mm ID, Glass Wool	990 µL	Split – Fast Injection	No	19251-60540
	Empty Pin & Cup	800 µL	Split – Manual Only	No	18740-80190
	Packed Pin & Cup	800 µL	Split – Manual Only	No	18740-60840

Splitless liner

The liner volume must contain the solvent vapor. The liner should be deactivated to minimize sample breakdown during the purge delay. Solvent vapor volume can be reduced by using Pulsed Splitless mode. Use the Vapor Volume Calculator to determine vapor volume requirements.

Vapor volume < 300 µL Use 2 mm liner (250 µL volume), 5181-8818 or similar.

Vapor volume 225 – 300 µL Consider pulsed splitless mode to reduce vapor volume.

Vapor volume > 300 µL Use 4 mm liner, 5062-3587 or similar.

Vapor volume > 800 µL Consider pulsed splitless mode to reduce vapor volume.

For thermally labile or reactive samples, use G1544-80700 (open top) or G1544-80730 (top taper) liners.

Table 30 Splitless mode liners











Liner	Description	Volume	Mode	Deactivated	Part Number
	Single Taper Glass Wool	900 uL	Splitless	Yes	5062-3587
	Single Taper	900 uL	Splitless	Yes	5181-3316

Table 30 Splitless mode liners (continued)

Liner	Description	Volume	Mode	Deactivated	Part Number
	Dual Taper	800 uL	Splitless	Yes	5181-3315
	2 mm Quartz	250 uL	Splitless	No	18740-80220
	2 mm Quartz	250 uL	Splitless	Yes	5181-8818
	1.5 mm	140 uL	Direct Inject, Purge and Trap, Headspace	No	18740-80200
	Single Taper Glass Wool	900 uL	Splitless	Yes	5062-3587
	Single Taper	900 uL	Splitless	Yes	5181-3316
	4 mm Single Taper	Direct column connect		Yes	G1544-80730
	4 mm Dual Taper	Direct column connect		Yes	G1544-80700

About the Purged Packed Column Inlet

This inlet is used with packed columns when high-efficiency separations are not required. It can also be used with wide-bore capillary columns, if flows greater than 10 mL/min are acceptable.

If the columns are not defined (packed columns and undefined capillary columns), the inlet is usually flow-controlled. If capillary columns are used and the columns in the flow path are defined, the inlet is normally pressure-controlled but can be put into the flow control mode.

About the Cool On-Column Inlet

This inlet introduces liquid sample directly onto a capillary column. To do this, both the inlet and the oven must be cool at injection, either at or below the boiling point of the solvent.

Because the sample does not vaporize immediately in the inlet, problems with sample discrimination and sample alteration are minimized. If done properly, cool-on column injection also provides accurate and precise results.

You can operate the inlet in track oven mode, where the inlet temperature follows the column oven, or you can program up to three temperature ramps. A cryogenic cooling option that uses liquid CO₂ or N₂ from the oven cryogenic system can reach sub-ambient temperatures.

Setup modes of the COC inlet

The COC inlet hardware must be set up for one of three usages, depending on the type of injection and column size.

- 0.25 mm or 0.32 mm automated on-column. Use predrilled septa.
- 0.53 mm automatic on-column or retention gap
- 0.2 mm manual

Retention gaps

Because the sample is injected directly onto the column, it is strongly suggested that a retention gap—or guard column—be used to protect your column. A retention gap is a deactivated column that is connected between the inlet and the analytical column. If you choose to use one, it is suggested that at least 1 m of retention gap be installed per 1 mL of sample injected. Information on ordering retention gaps can be found in the Agilent catalog for consumables and supplies.

About the PTV Inlet

The Agilent Programmed Temperature Vaporization (PTV) Inlet System has six operating modes:

- The *split mode* is generally used for major component analyses.
- The *pulsed split mode* is like the split mode, but with a pressure pulse applied to the inlet during sample introduction to speed the transfer of material to the column.
- The *splitless mode* is used for trace analyses.
- The *pulsed splitless mode* allows for a pressure pulse during sample introduction.
- The *solvent vent mode* is used for large volume injection. Either single or multiple injections can be made for each run.
- *Sleep mode* is used for creating sleep methods, or if all gas needs to flow onto the column.

The PTV inlet can be used with both manual and automatic injection.

For automatic multiple injections (large volume injections), an Agilent data system is required. This function is not available under GC control alone.

PTV sampling heads

Two heads are available for the PTV inlet.

The septum head uses either a regular septum or a Merlin Microseal™ to seal the syringe passage. A stream of gas sweeps the inner side of the septum and exits through the septum purge vent on the pneumatics module. It may be used with either automatic or manual injection.

The septum head uses either standard 11 mm septa or (with a different cap) a Merlin Microseal.

The septumless head uses a check valve instead of a septum to seal the syringe entrance passage. It may be used with either automatic or manual injection. This head is recommended for subambient inlet operation.

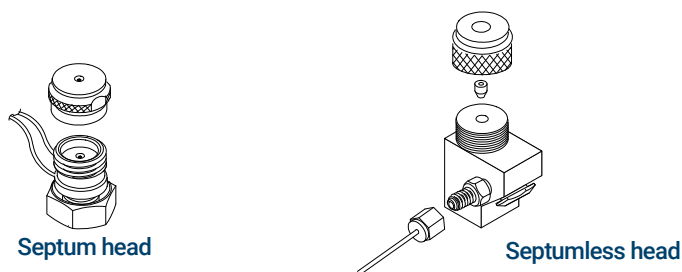

About the Volatiles Interface

The volatiles interface provides a simple, reliable way to introduce a gas sample into your GC from an external device such as a headspace, purge and trap, or air toxic sampler. Manual syringe injections cannot be made with this interface. The interface has a small volume and is highly inert, ensuring high sensitivity and resolution for applications requiring trace level detection.

Total flow to the interface is measured by a flow sensor and is divided into two streams. One stream connects to the septum purge regulator; the other splits to the gas-phase sampler (and from there is introduced into the interface) and the pressure sensing line. The pressure sensing line is measured by a pressure sensor. This stream also provides a trickle flow to the interface.

VI operating modes

There are three modes of operation—split, splitless, and direct. The pneumatics differ for each operating mode and are discussed in detail in the rest of this document.

Table 31 summarizes some issues to consider when choosing an operating mode. Specifications for the interface are also listed.

Table 31 Overview of the volatiles interface

Mode	Sample concentration	Sample to column	Comments
Split	High	Very little, most is vented	
Splitless	Low	All	Can switch to split mode electronically.
Direct	Low	All	Must physically disconnect split vent, plug the interface, and reconfigure the GC. Maximizes sample recovery and eliminates possibility of contamination to pneumatic system.

Table 32 Specifications of the volatiles interface

Specification	Value/Comment
Deactivated flow path	
Volume	32 μ L
Internal dimensions	2 mm by 10 mm
Maximum flow to interface	100 mL/min
Split range	Depends on column flow Typically no split to 100:1

Table 32 Specifications of the volatiles interface (continued)

Specification	Value/Comment
Temperature range	10 °C above ambient (with oven at ambient) to 400 °C
Recommended temperature:	≥ transfer line temperature of the external sampling device

About the VI split mode

When you introduce a sample in the split mode, a small amount of the sample enters the column while the major portion exits from the split vent. The ratio of split flow to column flow is controlled by the user. The split mode is primarily used for high concentration samples when you can afford to lose most of the sample out the split vent and for samples that cannot be diluted.

Split ratio

Because of the interface's small internal volume, the maximum total flow to the interface is 100 mL/min. This maximum flow puts some restriction on the split ratio you can set.

Table 33 Maximum split ratios

Column diameter (mm)	Column flow (mL/min)	Maximum split ratio	Total flow (mL/min)
0.20	1	100:1	100
0.53	5	20:1	100

Setpoint dependencies

Some setpoints are interdependent. If you change one setpoint, other setpoints may change to compensate. With a defined capillary column, setting column flow or linear velocity will set the inlet pressure.

Table 34 Setpoint dependencies

When you change	These setpoints change	
	Column defined	Column not defined
Pressure	Column flow* Split flow Total flow	No changes
Column flow*	Pressure Split flow Total flow	not available
Split flow	Split ratio Total flow	not available

Table 34 Setpoint dependencies (continued)

When you change	These setpoints change	
	Column defined	Column not defined
Split ratio	Split flow Total flow	not available
Total flow	Split flow Split ratio	No changes

* This setpoint appears in [Col 1] or [Col 2].

Initial values

Use the information in **Table 35** to help you set up the operating conditions for your interface.

Table 35 Suggested starting values

Parameter	Allowed setpoint range	Suggested starting value
Oven initial time	0 to 999.9 minutes	After sample on column
Interface temperature	Ambient + 10 °C to 400 °C	≥ Transfer line temperature
Gas saver time	0 to 999.9 minutes	After sample on column
Gas saver setpoint	15 to 100 mL/min	15 mL/min greater than maximum column flow

Split mode parameters

Inlet Mode The current operating mode—split

Heater Actual and setpoint interface temperatures

Pressure Actual and setpoint interface pressure. Controls capillary column flow.

Split ratio The ratio of split flow to column flow. This parameter is not available if your column is not defined.

Split flow Flow, in mL/min, from the split vent. This parameter is not available if your column is not defined.

Total flow The total flow into the interface, both setpoint and actual

Septum Purge Flow Flow through the septum purge vent

Gas saver Check to enable gas saver. Input **Time**, set reduced split vent flow, at least 15 mL/min.

About the VI splitless mode

This mode is used to concentrate sample at the head of the GC column during desorb. Purge timing delay must take into consideration the volume of the loop or trap in the external sampler plus the transfer line versus desorb/total flow rate. Cryo focusing is required for very volatile samples in splitless mode.

When you introduce a sample, the split valve remains closed while the sample enters the interface and is transferred to the column. At a specified time after the sample is introduced, the split valve opens.

Splitless mode pneumatics

Before Pre Run When the GC is preparing for sample introduction, total flow to the interface is measured by a flow sensor and controlled by a proportional valve. Column flow is controlled via back-pressure regulation. The split valve is open.

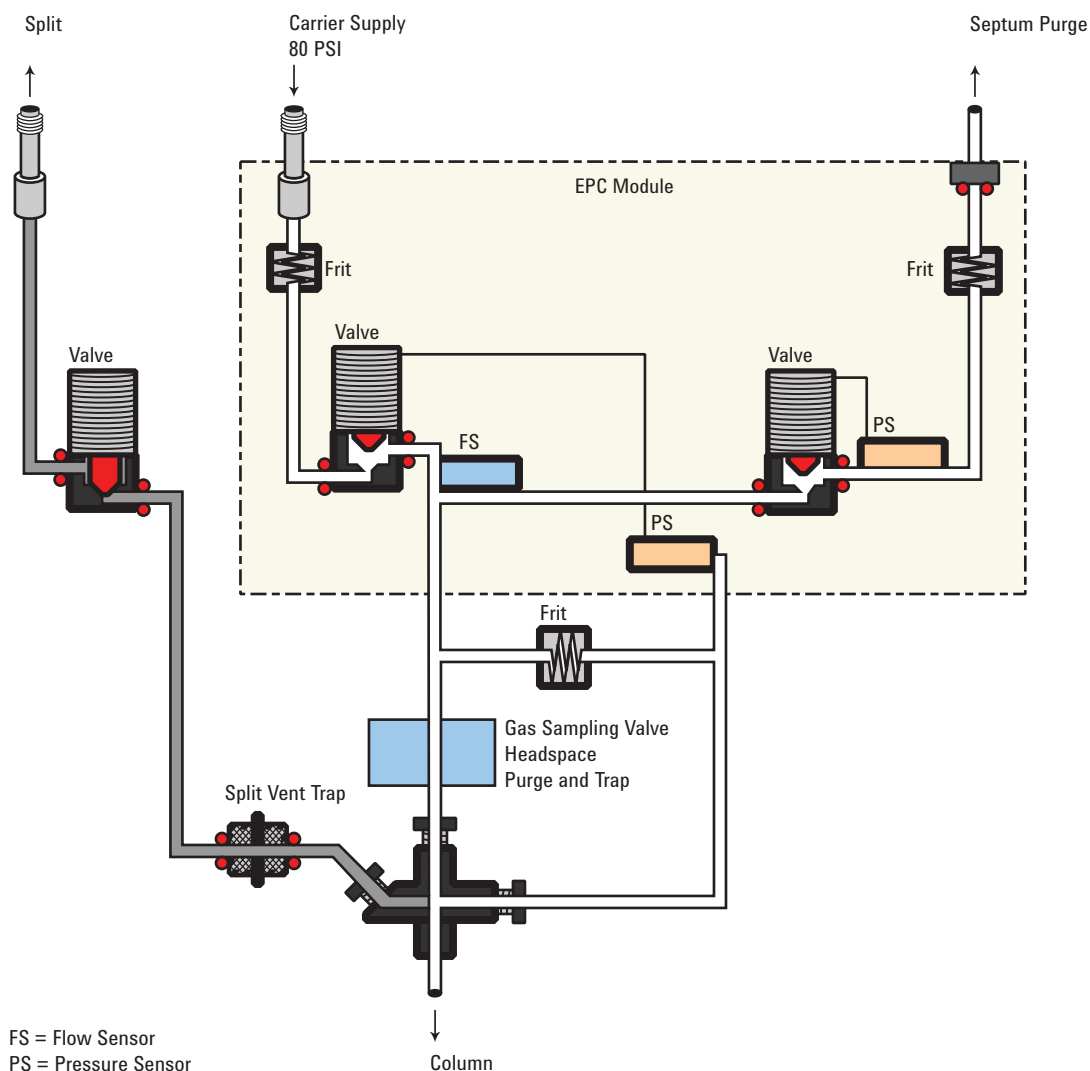

During sampling Pressure upsets caused by switching valves and trap restrictions in the external sampling device can cause fluctuations in column flow rates. To compensate for this, the interface is flow controlled during sampling time. The sampling flow rate is calculated from the pressure setpoint that is active when sample introduction begins. This flow control starts when the GC goes into the Pre Run state (when your system is automated and the Pre Run light is on or during manual operation when you press ) and ends after the interface's **Sampling end** setpoint expires.

Sampling end is required for purge and trap or thermal desorption systems and should be set \geq the sampler desorb time.

During this user-specified sampling period, the solenoid valve is closed. Flow to the interface is measured by a flow sensor and controlled by a proportional valve.

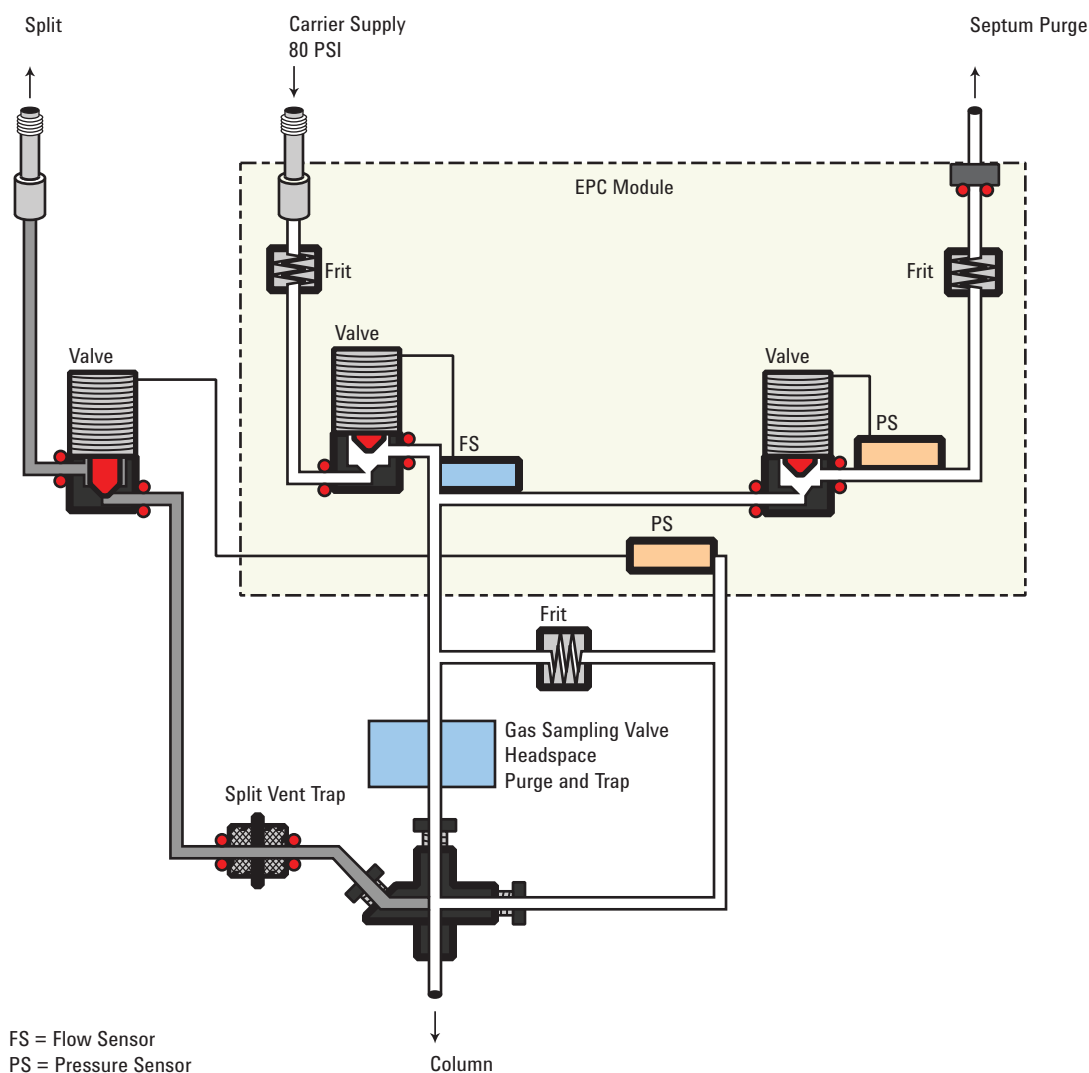

After sampling end The solenoid valve opens. The system returns to the **Before Prep Run** state. Flow to the interface is again measured by a flow sensor and controlled by a proportional valve while column flow is controlled via back-pressure regulation. The purge flow is controlled by the user. If desired, gas saver can be turned on at the end of the run.

Setpoint dependencies

Some setpoints in the flow system are interdependent. If you change one setpoint, other setpoints may change to compensate.

Table 36 Setpoint dependencies

When you change	These setpoints change	
	Column defined	Column not defined
		You can change the Pressure and Total flow setpoints; other setpoints are not affected.
Purge flow	Total flow**	
Pressure	Total flow** Column flow*	
Column flow*	Pressure Total flow**	
		You can change the Pressure setpoint; other setpoints are not affected.
Pressure	Column flow* Total flow**	
Column flow*	Pressure Total flow**	
You cannot change pressure and flow setpoints during sampling time.		

* This setpoint appears in the column parameters.

** This value is actual only.

Initial values

The table shows recommended starting values for selected parameters.

Table 37 Suggested starting values

Parameter	Allowed setpoint range	Suggested starting value
Oven initial time	0 to 999.9 minutes	≥ Interface purge time
Interface temperature	Ambient + 10 °C to 400 °C	≥ Transfer line temperature
Interface sampling end	0 to 999.9 minutes	0.2 minutes longer than introduction time
Interface purge time	0 to 999.9 minutes	
Gas saver time	0 to 999.9 minutes	Must be after purge time
Gas saver flow	15 to 100 mL/min	15 mL/min greater than maximum column flow

Splitless mode parameters

Inlet Mode The current operating mode—splitless

Heater Actual and setpoint interface temperatures. Column temperature must be low enough to cold trap the volatile sample. Cryo focusing is recommended.

Sampling end The sample introduction interval, in minutes. The flow rate is calculated from the pressure setpoint that is active at the start of sample introduction.

Set the sampling end setpoint 0.2 minutes longer than the time the sampler needs to introduce the sample. For example, the 7694 headspace sampler has an Inject time parameter which controls how long the valve remains in the inject position. If Inject time is 1 minute, the sampling end setpoint should be set to 1.2 minutes. If you're using an 7695 Purge and Trap Concentrator, set **Sampling end** 0.2 minutes longer than the Desorb time parameter.

If your column is defined and you specify a flow or pressure program for your column, the ramp does not begin until after the sampling end setpoint expires.

Pressure Actual and setpoint interface pressure in psi, bar, or kPa.

Purge flow to split vent The flow, in mL/min, from the split vent at **Purge time**. You will not be able to access or specify this value if your column is not defined. Also input the time, after the beginning of the run, when purging resumes. **Purge time** must be greater than **Sampling end**.

Total flow When your column is defined, **Total flow** displays the actual flow to the interface. You cannot enter a setpoint. If your column is not defined, **Total flow** will have both setpoint and actual values during purge time. All other times, the actual flow to the interface is displayed.

Septum Purge Flow through the septum purge vent, at least 15 mL/min.

Gas saver Check to enable gas saver. Input **Time**, set reduced split vent flow, at least 15 mL/min.

About the VI direct mode

Direct sample introduction permits a quantitative transfer of analyte without risking contamination to the pneumatic system. It provides the sensitivity required for air toxic analyses. The interface's minimal dead volume also eliminates the potential interaction of solutes with poorly swept, active surfaces.

To operate in the direct mode, you must physically disconnect the split vent and reconfigure the GC.

Before Pre Run

The interface is forward pressure controlled; pressure is sensed downstream from the flow proportional valve.

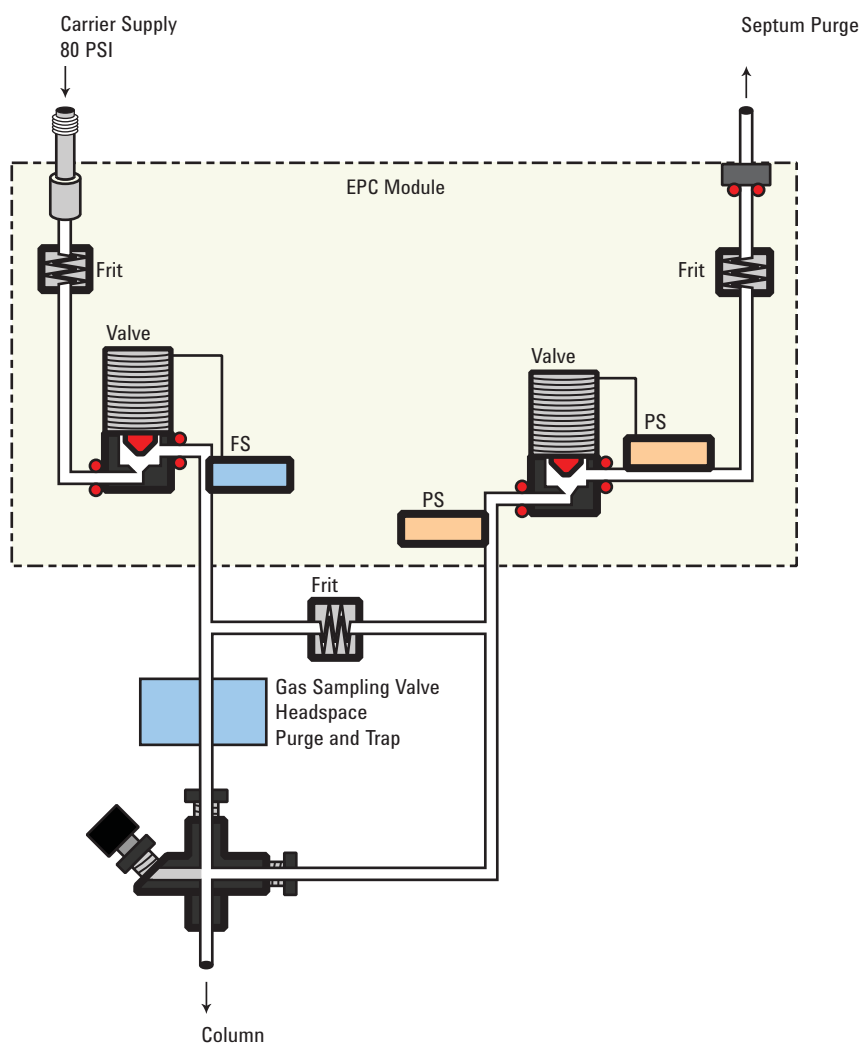

During sampling

Pressure upsets caused by switching valves in the external sampler can cause fluctuations in column flow rates. To compensate for this, the interface is flow controlled during sampling time. The sampling flow rate is calculated from the pressure setpoint that is active when sample introduction begins. This flow control starts when the GC goes into the Pre Run state (when your system is automated and the Pre Run light is on or during manual operation when you press  and ends after the interface's **Sampling end** setpoint expires.

Flow to the interface is measured by a flow sensor and controlled by a proportional valve.

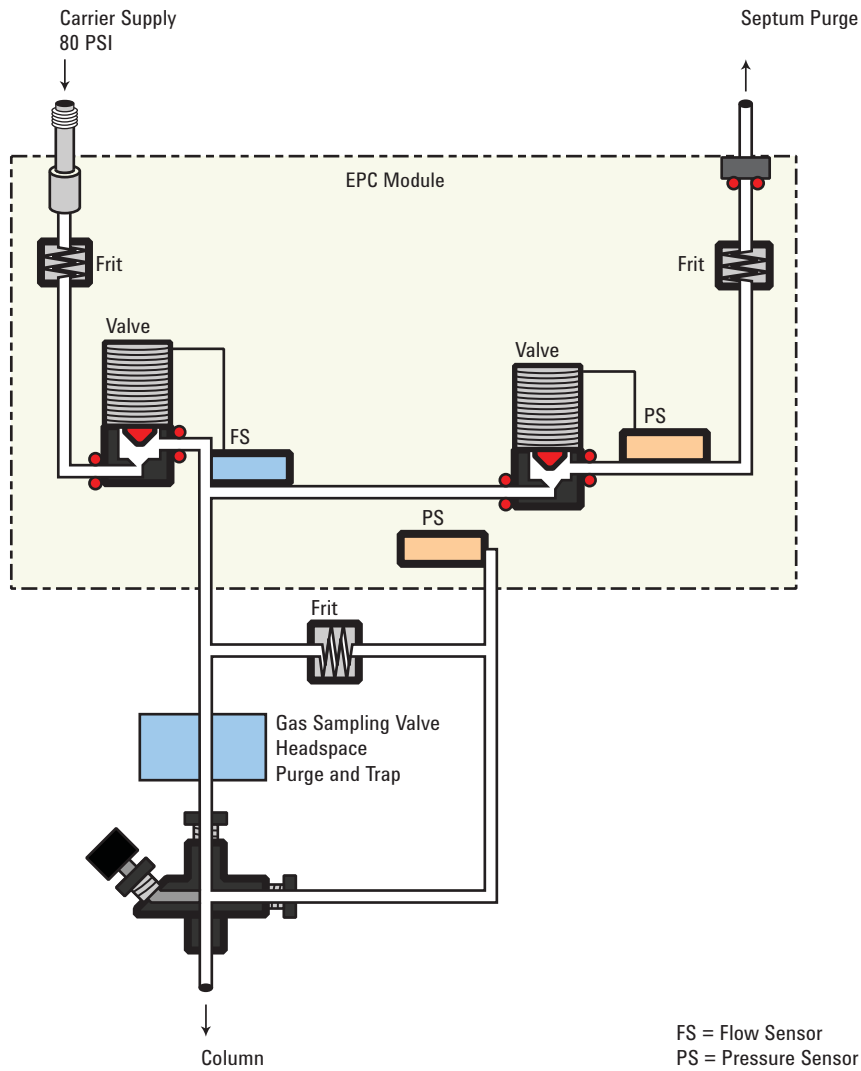

After sampling end

The interface is forward pressure controlled; pressure is sensed downstream from the proportional valve. The system returns to the idle state.

Preparing the Interface for Direct Sample Introduction

Before you can operate your interface in direct mode, you must:

- **Disconnect** the split vent line
- **Configure** the GC for a direct injection

Disconnecting the split vent line

WARNING

Be careful! The interface may be hot enough to cause burns.

- 1 Turn off the interface temperature and pressure and allow the interface to cool.
- 2 If desired, remove the transfer line by loosening the hex nut with a wrench.
- 3 Remove the clamping plate from the interface by loosening the captive screw with a screwdriver. Put the plate in a safe place.

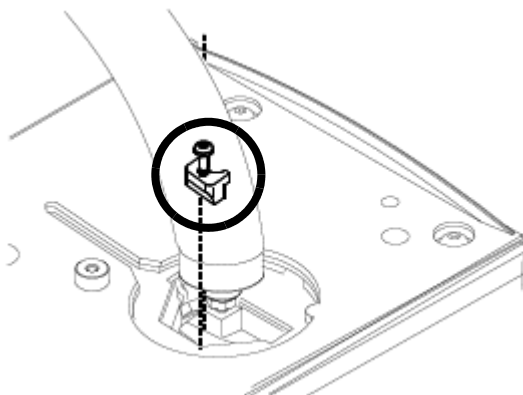

- 4 Carefully lift the interface out of the heater block.

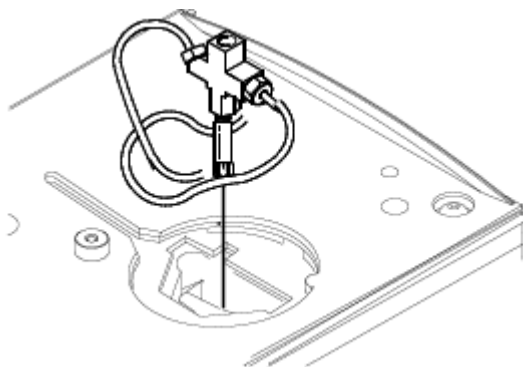

- 5 Loosen the hex nut connecting the split vent line to the interface until you can remove the line. Put the line aside. You do not need to plug it.

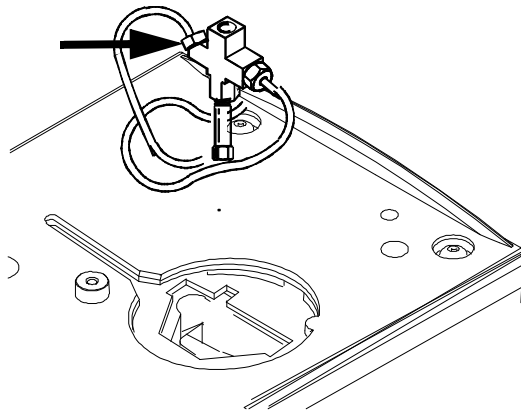

- 6 Install a blanking nut into the split line port and finger-tighten the nut. Tighten the nut an additional 1/4-turn using two wrenches in opposition.

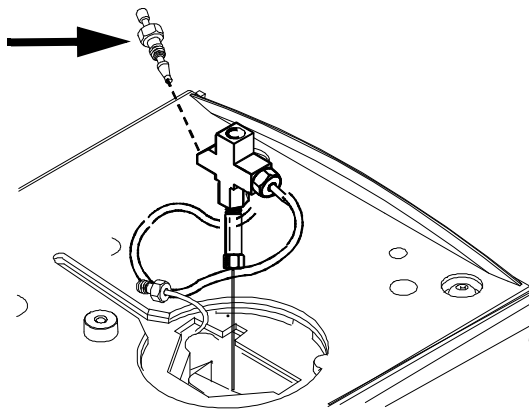

- 7 Place the interface in the heater block. Replace the clamping plate you removed earlier and tighten the screw until snug. Do not overtighten. If you removed the transfer line, replace it.

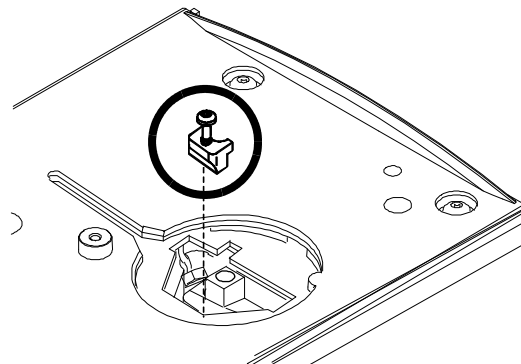

- 8 Restore the GC to normal operating conditions. Perform a leak test on the interface fittings.

Configuring the GC for a direct injection

The GC cannot sense the presence of the split vent. When you disconnect or reconnect the vent, you must configure the GC so that the pneumatics work properly.

VI direct mode setpoint dependencies

Some setpoints in the flow system are interdependent. If you change one setpoint, other setpoints may change to compensate.

Table 38 Setpoint changes

When you change	These setpoints change	
	Column defined	Column not defined
		The Column flow* setpoint is not available.
Pressure	Column flow* Total flow**	You can change the pressure setpoint; other setpoints are not affected.
Column flow*	Pressure Total flow**	
	You cannot change pressure and flow setpoints during sampling time.	

* This setpoint appears in the column parameters

** This value is actual only

VI direct mode initial values

Use the information in **Table 39** to help you set up the operating conditions for your interface.

Table 39 Suggested starting values

Parameter	Allowed setpoint range	Suggested starting value
Oven initial time	0 to 999.9 minutes	≥ interface sampling end
Interface temperature	Ambient + 10 °C to 400 °C	≥ transfer line temperature
Interface sampling end	0 to 999.9 minutes	0.2 minutes longer than actual sampling time

Direct mode parameters

Temperature Actual and setpoint interface temperatures

Sampling end The sample introduction interval, in minutes. The flow rate is calculated from the pressure setpoint that is active at the start of sample introduction.

Set **Sampling end** 0.2 minutes longer than the time the sampler needs to introduce the sample. For example, the 7694 headspace sampler has an **Inject time** parameter which controls how long the valve remains in the inject position. If **Inject time** is 1 minute, **Sampling end** should be set to 1.2 minutes. If you're using a 7695 Purge and Trap Concentrator, set **Sampling end** 0.2 minutes longer than the **Desorb time** parameter.

If your column is defined and you specify a flow or pressure program for your column, the ramp does not begin until after **Sampling end** expires.

Pressure Actual and setpoint interface pressure before a run and after sampling time.

Total flow The actual flow to the interface. This is a reported value, not a setpoint.

Septum Purge Flow through the septum purge vent, range 0 to 30 mL/min.

About the Oven Insert 230

Hydrogen Sensor 231

Instrument logs 231

Calibration 231

Status information 231

Operation with an Agilent data system 231

About the Oven Insert

The Oven Insert for Fast Chromatography reduces the oven volume so that the column and sample heat more quickly, yielding faster separation and faster chromatography. Furthermore, the smaller volume oven cools faster than a full-sized oven, reducing the overall analytical cycle time.

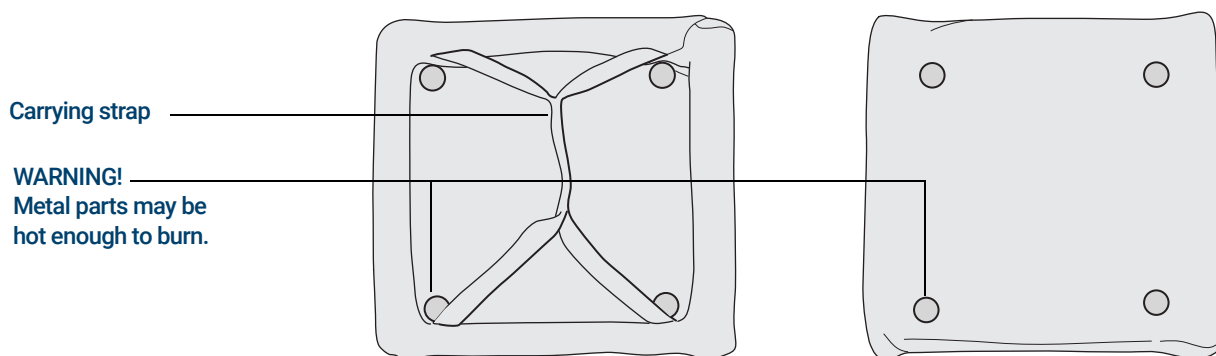

The oven insert is used with any inlet, column, and detector mounted in the **back** position. It is not compatible with any accessory which obstructs access to the front of the oven or which requires the use of either the front inlet or the front part of the oven.

Hydrogen Sensor

The optional Hydrogen Sensor module checks for uncombusted free hydrogen in the GC column oven. During normal operation with hydrogen as a carrier gas, leaks from the inlets or detectors could possibly put hydrogen gas directly into the oven. Hydrogen–air mixtures are potentially explosive in concentrations of 4–74.2% hydrogen by volume. The sensor monitors the free hydrogen level in the oven and will trigger a shutdown of all hydrogen gas flows if the hydrogen level in the oven is > 1%.

In the event of a hydrogen safety shutdown, the GC records the event in its Event log.

See the *Troubleshooting* manual for more information about GC shutdown events and how to clear them.

The GC can only shut down hydrogen gas flows that have been configured properly. Always configure the gas types used for the inlets, detectors, and so forth.

Instrument logs

The GC will log the following hydrogen sensor events in its event logs:

- Hydrogen safety shutdowns initiated by the hydrogen sensor
- Calibrations
- Hydrogen sensor tests

Calibration

The hydrogen sensor requires periodic calibration for optimal performance. If the sensor is not calibrated on schedule or if a calibration fails for any reason (for example, a lack of calibration gas), the sensor continues to use its existing calibration data.

Status information

If a calibration fails, a notification will appear on the diagnostics tab.

Operation with an Agilent data system

Using the hydrogen sensor with an Agilent data system provides additional features. Use the data system to:

- Print calibration reports. The report includes a plot of all calibration data stored in the GC,
- Access the automated calibration schedule control (on/off).
- Store lot number and expiration date information for the calibration gas cylinder.
- View the hydrogen sensor status information in the GC status user interface. The status shows the current percent hydrogen level and any messages related to the hydrogen sensor.
- Plot the measured hydrogen level as a diagnostic signal, if desired.
- View and print all logged entries for calibrations, cylinder information, and shutdowns.

Chromatographic Checkout

About Chromatographic Checkout	234
To Prepare for Chromatographic Checkout	235
To Check FID Performance	237
To Check TCD Performance	242
To Check NPD Performance	246
To Check ECD Performance	250
To Check FPD+ Performance (Sample 5188-5953)	254
Preparation	254
Phosphorus performance	254
Sulfur performance	258
To Check FPD+ Performance (Sample 5188-5245, Japan)	260
Preparation	260
Phosphorus performance	260
Sulfur performance	264

This section describes the general procedure for verifying performance against the original factory standards. The checkout procedures described here assume a GC that has been in use for some period of time. Therefore the procedures ask that you perform bakeouts, replace consumable hardware, install the checkout column, and so forth.

About Chromatographic Checkout

The tests described in this section provide basic confirmation that the GC and detector can perform comparably to factory condition. However, as detectors and the other parts of the GC age, detector performance can change. The results presented here represent typical outputs for typical operating conditions and are not specifications.

The tests assume the following:

- Use of an automatic liquid sampler. If not available, use a suitable manual syringe instead of the syringe listed.
- Use of a 10 μL syringe in most cases. However, a 5 μL syringe is an acceptable substitute.
- Use of the septa and other hardware (liners, jets, adapters, and so forth) described. If you substitute other hardware, performance can vary.

To Prepare for Chromatographic Checkout

Because of the differences in chromatographic performance associated with different consumables, Agilent strongly recommends using the parts listed here for all checkout tests. Agilent also recommends installing new consumable parts whenever the quality of the installed ones is not known. For example, installing a new liner and septum ensures that they will not contribute any contamination to the results.

When the GC is delivered from the factory, these consumable parts are new and do not need replacement.

NOTE

For a new GC, check the installed inlet liner. The liner shipped in the inlet may not be the liner recommended for checkout.

- 1 Check the indicators/dates on any gas supply traps. Replace/recondition expended traps.
- 2 Install new consumable parts for the inlet and prepare the correct injector syringe (and needle, as needed).

Table 40 Recommended parts for checkout by inlet type

Recommended part for checkout	Part number
Split splitless inlet	
Syringe, 10- μ L	5181-1267
O-ring	5188-5365
Septum	5183-4757
Liner	5190-2295
Multimode inlet	
Syringe, 10- μ L	5181-1267
O-ring	5188-6405
Septum	5183-4757
Liner	5190-2295
Purged packed column inlet	
Syringe, 10- μ L	5181-1267
O-ring	5080-8898
Septum	5183-4757

Table 40 Recommended parts for checkout by inlet type

Recommended part for checkout	Part number
Cool on-column inlet	
Septum	5183-4758
Septum nut	19245-80521
Syringe, 5- μ L on-column	5182-0836
0.32-mm needle for 5- μ L syringe	5182-0831
7693A ALS: Needle support insert, COC	G4513-40529
Insert, fused silica, 0.32-mm id	19245-20525
PTV inlet	
Syringe, 10- μ L—for septum head	5181-1267
Syringe, 10- μ L, 23/42/HP—for septumless head	5181-8809
Inlet adapter, Graphpak-2M	5182-9761
Silver seal for Graphpak-2M	5182-9763
Glass liner, multibaffle	5183-2037
PTFE ferrule (septumless head)	5182-9748
Microseal replacement (if installed)	5182-3444
Ferrule, Graphpak-3D	5182-9749

Table 41 Checkout standards

Standard	Part number	Number of ampoules
FID checkout	5188-5372	3
TCD checkout	18710-60170	3
ECD checkout	18713-60040	3
NPD checkout	18789-60060	3
FPD+ checkout (methyl parathion)	5188-5953	3
OQ/PV Headspace checkout	5182-9733	1

To Check FID Performance

- 1 Gather the following:
 - Evaluation column, HP-5 30 m × 0.32 mm × 0.25 μm (19091J-413)
 - FID performance evaluation (checkout) sample (5188-5372)
 - Chromatographic-grade isooctane
 - 4-mL solvent and waste bottles or equivalent for autoinjector
 - 2-mL sample vials or equivalent for sample
 - Inlet and injector hardware (See **"To Prepare for Chromatographic Checkout."**)
- 2 Verify the following:
 - Capillary column jet installed. If not, select and install a capillary column jet.
 - Capillary column adapter installed. If not, install it.
 - Chromatographic-grade gases plumbed and configured: helium as carrier gas, nitrogen, hydrogen, and air.
 - Empty waste vials loaded in sample turret.
 - 4-mL solvent vial with diffusion cap filled with isooctane and inserted in Solvent A injector position.
- 3 Replace consumable parts (liner, septum, traps, syringe, and so forth) as needed for the checkout. See **"To Prepare for Chromatographic Checkout."**
- 4 Install the evaluation column.
 - Bake out the evaluation column for at least 30 min at 180 °C.
 - Be sure to configure the column.
- 5 Check the FID baseline output. The output should be between 5 pA and 20 pA and relatively stable. (If using a gas generator or ultra pure gas, the signal may stabilize below 5 pA.) If the output is outside this range or unstable, resolve this problem before continuing.
- 6 If the output is too low:
 - Check that the electrometer is on.
 - Check that the flame is lit.
 - Check that the signal is set to the correct detector.
- 7 Create or load a method with the parameter values listed in **Table 42**.

Table 42 FID Checkout Conditions

Column and sample	
Type	HP-5, 30 m × 0.32 mm × 0.25 μm (19091J-413)
Sample	FID checkout 5188-5372
Column flow	6.5 mL/min
Column mode	Constant flow.

Table 42 FID Checkout Conditions



Split/splitless inlet	
Temperature	250 °C
Mode	Splitless
Purge flow	40 mL/min
Purge time	0.5 min
Septum purge	3 mL/min
Gas saver	Off
Multimode inlet	
Mode	Splitless
Inlet temperature	75 °C
Initial time	0.1 min
Rate 1	720 °C/min
Final temp 1	250 °C
Final time 1	5.0 min
Purge time	1.0 min
Purge flow	40 mL/min
Septum purge	3 mL/min
Purged packed column inlet	
Temperature	250 °C
Septum purge	3 mL/min
Cool on-column inlet	
Temperature	Track oven
Septum purge	15 mL/min

Table 42 FID Checkout Conditions

PTV inlet	
Mode	Splitless
Inlet temperature	75 °C
Initial time	0.1 min
Rate 1	720 °C/min
Final temp 1	350 °C
Final time 1	2 min
Rate 2	100 °C/min
Final temp 2	250 °C
Final time 2	0 min
Purge time	0.5 min
Purge flow	40 mL/min
Septum purge	3 mL/min
Detector	
Temperature	300 °C
H2 flow	30 mL/min
Air flow	400 mL/min
Makeup flow (N2)	25 mL/min
Lit offset	Typically 2 pA
Oven	
Initial temp	75 °C
Initial time	0.5 min
Rate 1	20 °C/min
Final temp	190 °C
Final time	0 min

Table 42 FID Checkout Conditions

ALS settings (if installed)	
Sample washes	2
Sample pumps	6
Sample wash volume	8 (maximum)
Injection volume	1 μ L
Syringe size	10 μ L
Solvent A pre washes	2
Solvent A post washes	2
Solvent A wash volume	8
Solvent B pre washes	0
Solvent B post washes	0
Solvent B wash volume	0
Injection mode (7693A)	Normal
Airgap Volume (7693A)	0.20
Viscosity delay	0
Inject Dispense Speed (7693A)	6000
PreInjection dwell	0
PostInjection dwell	0
Manual injection	
Injection volume	1 μ L
Data system	
Data rate	5 Hz

- 8 If using a data system, prepare the data system to perform one run using the loaded checkout method. Make sure that the data system will output a chromatogram.
If not using a data system, create a one sample sequence using the GC Browser Interface.
- 9 Start the run.
If performing an injection using an autosampler, start the run using the data system, or press .
If performing a manual injection (with or without a data system):
 - a Select  to prepare the inlet for splitless injection.
 - b When the GC becomes ready, inject 1 μ L of the checkout sample and select  on the GC.
 - c The following chromatogram shows typical results for a new detector with new consumable parts installed and nitrogen makeup gas.

17 Chromatographic Checkout

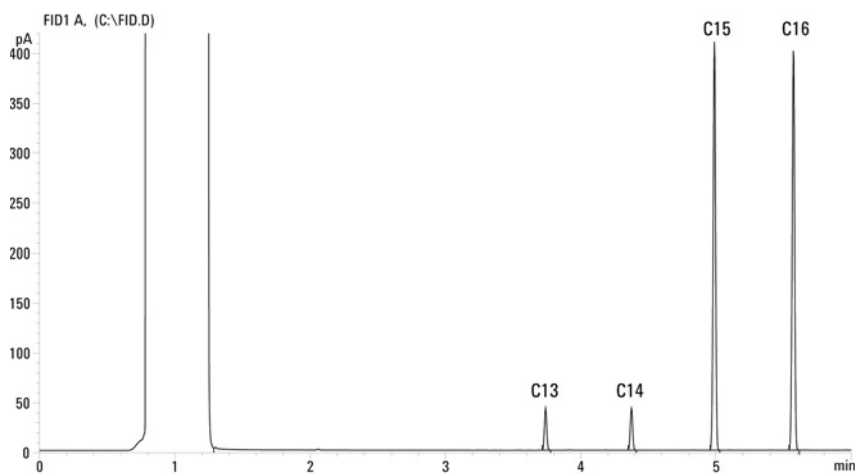

To Check TCD Performance

-
- 1 Gather the following:
 - Evaluation column, HP-5 30 m × 0.32 mm × 0.25 μm (19091J-413)
 - FID/TCD performance evaluation (checkout) sample (18710-60170)
 - 4-mL solvent and waste bottles or equivalent for autoinjector
 - Chromatographic-grade hexane
 - 2-mL sample vials or equivalent for sample
 - Chromatographic-grade helium as carrier, makeup, and reference gas
 - Inlet and injector hardware See **“To Prepare for Chromatographic Checkout.”**
- 2 Verify the following:
 - Chromatographic-grade gases plumbed and configured: helium as carrier gas and reference gas.
 - Empty waste vials loaded in sample turret.
 - 4-mL solvent vial with diffusion cap filled with hexane and inserted in Solvent A injector position.
- 3 Replace consumable parts (liner, septum, traps, syringe, and so forth) as needed for the checkout. See **“To Prepare for Chromatographic Checkout.”**
- 4 Install the evaluation column.
 - Bake out the evaluation column for at least 30 min at 180 °C.
 - Configure the column
- 5 Create or load a method with the parameter values listed in **Table 43.**

Table 43 TCD Checkout Conditions

Column and sample	
Type	HP-5, 30 m × 0.32 mm × 0.25 μm (19091J-413)
Sample	FID/TCD checkout 18710-60170
Column flow	6.5 mL/min
Column mode	Constant flow.
Split/splitless inlet	
Temperature	250 °C
Mode	Splitless
Purge flow	60 mL/min
Purge time	0.75 min
Septum purge	3 mL/min

Table 43 TCD Checkout Conditions (continued)

Multimode inlet	
Mode	Splitless
Inlet temperature	40 °C
Initial time	0.1 min
Rate 1	720 °C/min
Final temp 1	350 °C
Final time 1	2 min
Purge time	1.0 min
Purge flow	40 mL/min
Septum purge	3 mL/min
Purged packed column inlet	
Temperature	250 °C
Septum purge	3 mL/min
Cool on-column inlet	
Temperature	Oven track
Septum purge	15 mL/min
PTV inlet	
Mode	Splitless
Inlet temperature	40 °C
Initial time	0.1 min
Rate 1	720 °C/min
Final temp 1	350 °C
Final time 1	2 min
Rate 2	100 °C/min
Final temp 2	250 °C
Final time 2	0 min
Purge time	0.5 min
Purge flow	40 mL/min
Septum purge	3 mL/min
Detector	
Temperature	300 °C
Reference flow (He)	30 mL/min
Makeup flow (He)	2 mL/min
Baseline output	< 30 display counts on Agilent OpenLAB CDS ChemStation Edition (< 750 μ V)

Table 43 TCD Checkout Conditions (continued)

Oven	
Initial temp	75 °C
Initial time	0.5 min
Rate 1	20 °C/min
Final temp	190 °C
Final time	6.25 min
ALS settings (if installed)	
Sample washes	2
Sample pumps	6
Sample wash volume	8 (maximum)
Injection volume	1 µL
Syringe size	10 µL
Solvent A pre washes	2
Solvent A post washes	2
Solvent A wash volume	8
Solvent B pre washes	0
Solvent B post washes	0
Solvent B wash volume	0
Injection mode (7693A)	Normal
Airgap Volume (7693A)	0.20
Viscosity delay	0
Inject Dispense Speed (7693A)	6000
PreInjection dwell	0
PostInjection dwell	0
Manual injection	
Injection volume	1 µL
Data system	
Data rate	5 Hz

- 6 Display the signal output. A stable output at any value between 12.5 and 750 µV (inclusive) is acceptable.
- If the baseline output is < 0.5 display units (< 12.5 µV), verify that the detector filament is on. If the offset is still < 0.5 display units (< 12.5 µV), your detector requires service.
 - If baseline output is > 30 display units (> 750 µV), there may be chemical contamination contributing to the signal. Bakeout the TCD. If repeated cleanings do not give an acceptable signal, check gas purity. Use higher purity gases and/or install traps.

17 Chromatographic Checkout

7 If using a data system, prepare the data system to perform one run using the loaded checkout method. Make sure that the data system will output a chromatogram.

8 Start the run.

If performing an injection using an autosampler, start the run using the data system or press .

If performing a manual injection (with or without a data system):

a Select  to prepare the inlet for splitless injection.

b When the GC becomes ready, inject 1 μL of the checkout sample and select  on the touchscreen.

c The following chromatogram shows typical results for a new detector with new consumable parts installed.

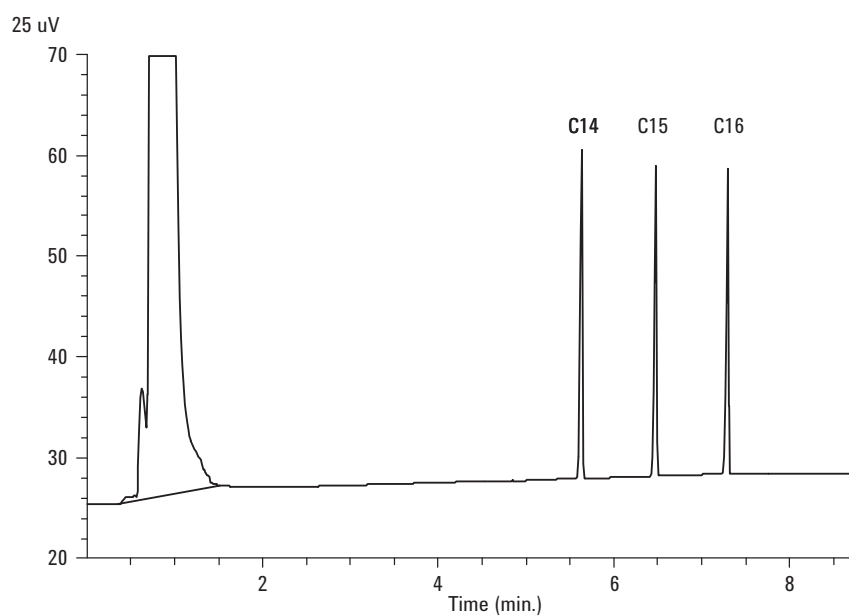

To Check NPD Performance

- 1 Gather the following:
 - Evaluation column, HP-5 30 m × 0.32 mm × 0.25 μm (19091J-413)
 - NPD performance evaluation (checkout) sample (18789-60060)
 - 4-mL solvent and waste bottles or equivalent for autoinjector.
 - Chromatographic-grade isooctane
 - 2-mL sample vials or equivalent for sample.
 - Inlet and injector hardware See **“To Prepare for Chromatographic Checkout.”**
- 2 Verify the following:
 - Capillary column jet installed. If not, select and install a capillary column jet.
 - Chromatographic-grade gases plumbed and configured: helium as carrier gas, nitrogen, hydrogen, and air.
 - Empty waste vials loaded in sample turret.
 - 4-mL vial with diffusion cap filled with isooctane and inserted in Solvent A injector position.
- 3 Replace consumable parts (liner, septum, traps, syringe, and so forth) as needed for the checkout. See **“To Prepare for Chromatographic Checkout.”**
- 4 If present, remove any protective caps from the inlet manifold vents.
- 5 Install the evaluation column.
 - Bake out the evaluation column for at least 30 min at 180 °C.
 - Be sure to configure the column
- 6 Create or load a method with the parameter values listed in **Table 44.**

Table 44 NPD Checkout Conditions

Column and sample	
Type	HP-5, 30 m × 0.32 mm × 0.25 μm (19091J-413)
Sample	NPD checkout 18789-60060
Column mode	Constant flow
Column flow	6.5 mL/min (helium)
Split/splitless inlet	
Temperature	200 °C
Mode	Splitless
Purge flow	60 mL/min
Purge time	0.75 min
Septum purge	3 mL/min

Table 44 NPD Checkout Conditions (continued)

Multimode inlet	
Mode	Splitless
Inlet temperature	60 °C
Initial time	0.1 min
Rate 1	720 °C/min
Final temp 1	350 °C
Final time 1	2 min
Purge time	1.0 min
Purge flow	60 mL/min
Septum purge	3 mL/min
Purged packed column inlet	
Temperature	200 °C
Septum purge	3 mL/min
Cool on-column inlet	
Temperature	Track oven
Septum purge	15 mL/min
PTV inlet	
Mode	Splitless
Inlet temperature	60 °C
Initial time	0.1 min
Rate 1	720 °C/min
Final temp 1	350 °C
Final time 1	2 min
Rate 2	100 °C/min
Final temp 2	250 °C
Final time 2	0 min
Purge time	0.75 min
Purge flow	60 mL/min
Septum purge	3 mL/min
Detector	
Temperature	300 °C
H2 flow	3 mL/min
Air flow	60 mL/min
Makeup flow (N2)	Makeup + column = 3 mL/min
Output	20 display units (20 pA)

Table 44 NPD Checkout Conditions (continued)

Oven	
Initial temp	60 °C
Initial time	0 min
Rate 1	20 °C/min
Final temp	200 °C
Final time	3 min
ALS settings (if installed)	
Sample washes	2
Sample pumps	6
Sample wash volume	8 (maximum)
Injection volume	1 µL
Syringe size	10 µL
Solvent A pre washes	2
Solvent A post washes	2
Solvent A wash volume	8
Solvent B pre washes	0
Solvent B post washes	0
Solvent B wash volume	0
Injection mode (7693A)	Normal
Airgap Volume (7693A)	0.20
Viscosity delay	0
Inject Dispense Speed (7693A)	6000
PreInjection dwell	0
PostInjection dwell	0
Manual injection	
Injection volume	1 µL
Data system	
Data rate	5 Hz

7 If using a data system, prepare the data system to perform one run using the loaded checkout method. Make sure that the data system will output a chromatogram.

8 Start the run.

If performing an injection using an autosampler, start the run using the data system, or creating a one sample sequence and pressing  on the touchscreen.

If performing a manual injection (with or without a data system):

- a Select  to prepare the inlet for splitless injection.

17 Chromatographic Checkout

- b When the GC becomes ready, inject 1 μL of the checkout sample and press . The following chromatogram shows typical results for a new detector with new consumable parts installed.

To Check ECD Performance

- 1 Gather the following:
 - Evaluation column, HP-5 30 m × 0.32 mm × 0.25 μm (19091J-413)
 - ECD performance evaluation (checkout) sample (18713–60040, Japan: 5183-0379)
 - 4-mL solvent and waste bottles or equivalent for autoinjector.
 - Chromatographic-grade isooctane
 - 2-mL sample vials or equivalent for sample.
 - Inlet and injector hardware See **“To Prepare for Chromatographic Checkout.”**
- 2 Verify the following:
 - Clean fused silica indented mixing liner installed. If not, install it.
 - Chromatographic-grade gases plumbed and configured: helium for carrier gas, nitrogen for makeup.
 - Empty waste vials loaded in sample turret.
 - 4-mL vial with diffusion cap filled with hexane and inserted in Solvent A injector position.
- 3 Replace consumable parts (liner, septum, traps, syringe, and so forth) as needed for the checkout. See **“To Prepare for Chromatographic Checkout.”**
- 4 Install the evaluation column.
 - Bake out the evaluation column for at least 30 minutes at 180 °C.
 - Be sure to configure the column.
- 5 Display the signal output to determine baseline output. A stable baseline output at any value between 0.5 and 1000 Hz (OpenLAB CDS ChemStation Edition display units) (inclusive) is acceptable.
 - If the baseline output is < 0.5 Hz, verify that the electrometer is on. If the offset is still < 0.5 Hz, your detector requires service.
 - If the baseline output is > 1000 Hz, there may be chemical contamination contributing to the signal. Bakeout the ECD. If repeated cleanings do not give an acceptable signal, check gas purity. Use higher purity gases and/or install traps.
- 6 Create or load a method with the parameter values listed in **Table 45**.

Table 45 ECD Checkout Conditions

Column and sample	
Type	HP-5, 30 m × 0.32 mm × 0.25 μm (19091J-413)
Sample	ECD checkout (18713-60040 or Japan: 5183-0379)
Column mode	Constant flow
Column flow	6.5 mL/min (helium)

Table 45 ECD Checkout Conditions (continued)

Split/splitless inlet	
Temperature	250 °C
Mode	Splitless
Purge flow	60 mL/min
Purge time	0.75 min
Septum purge	3 mL/min
Multimode inlet	
Mode	Splitless
Inlet temperature	80 °C
Initial time	0.1 min
Rate 1	720 °C/min
Final temp 1	250 °C
Final time 1	5 min
Purge time	1.0 min
Purge flow	60 mL/min
Septum purge	3 mL/min
Purged packed column inlet	
Temperature	250 °C
Septum purge	3 mL/min
Cool on-column inlet	
Temperature	Track oven
Septum purge	15 mL/min
PTV inlet	
Mode	Splitless
Inlet temperature	80 °C
Initial time	0.1 min
Rate 1	720 °C/min
Final temp 1	350 °C
Final time 1	2 min
Rate 2	100 °C/min
Final temp 2	250 °C
Final time 2	0 min
Purge time	0.75 min
Purge flow	60 mL/min
Septum purge	3 mL/min

Table 45 ECD Checkout Conditions (continued)

Detector	
Temperature	300 °C
Makeup flow (N2)	25 mL/min (constant + makeup)
Baseline output	Should be < 1000 display counts. In Agilent OpenLAB CDS ChemStation Edition (< 1000 Hz)
Oven	
Initial temp	80 °C
Initial time	0 min
Rate 1	15 °C/min
Final temp	180 °C
Final time	10 min
ALS settings (if installed)	
Sample washes	2
Sample pumps	6
Sample wash volume	8 (maximum)
Injection volume	1 µL
Syringe size	10 µL
Solvent A pre washes	2
Solvent A post washes	2
Solvent A wash volume	8
Solvent B pre washes	0
Solvent B post washes	0
Solvent B wash volume	0
Injection mode (7693A)	Normal
Airgap Volume (7693A)	0.20
Viscosity delay	0
Inject Dispense Speed (7693A)	6000
PreInjection dwell	0
PostInjection dwell	0
Manual injection	
Injection volume	1 µL
Data system	
Data rate	5 Hz

- 7 If using a data system, prepare the data system to perform one run using the loaded checkout method. Make sure that the data system will output a chromatogram.

17 Chromatographic Checkout

8 Start the run.

If performing an injection using an autosampler, start the run using the data system or press .

If performing a manual injection (with or without a data system):

a Select  to prepare the inlet for splitless injection.

b When the GC becomes ready, inject 1 μL of the checkout sample and press .

9 The following chromatogram shows typical results for a new detector with new consumable parts installed. The Aldrin peak will be missing when using the Japanese sample 5183-0379.

To Check FPD+ Performance (Sample 5188-5953)

To check FPD⁺ performance, first check the phosphorus performance, then the sulfur performance.

Preparation

- 1 Gather the following:
 - Evaluation column, HP-5 30 m × 0.32 mm × 0.25 μm (19091J-413)
 - FPD+ performance evaluation (checkout) sample (5188-5953), 2.5 mg/L (± 0.5%) methylparathion in isooctane
 - Phosphorus filter
 - Sulfur filter and filter spacer
 - 4-mL solvent and waste bottles or equivalent for autoinjector.
 - 2-mL sample vials or equivalent for sample.
 - Chromatographic-grade isooctane for syringe wash solvent.
 - Inlet and injector hardware See **"To Prepare for Chromatographic Checkout."**
- 2 Verify the following:
 - Chromatographic-grade gases plumbed and configured: helium as carrier gas, nitrogen, hydrogen, and air.
 - Empty waste vials loaded in sample turret.
 - 4-mL vial with diffusion cap filled with isooctane and inserted in Solvent A injector position.
- 3 Replace consumable parts (liner, septum, traps, syringe, and so forth) as needed for the checkout. See **"To Prepare for Chromatographic Checkout."**
- 4 Verify that the **Lit Offset** is set appropriately. Typically, it should be about 2.0 pA for the checkout method.
- 5 Install the evaluation column.
- 6 Set the oven, inlet, and detector to 250 °C and bake out for at least 15 minutes.
- 7 Be sure to configure the column.

Phosphorus performance

- 1 If it is not already installed, install the phosphorus filter.
- 2 Create or load a method with the parameter values listed in **Table 46**.

Table 46 FPD⁺ Checkout Conditions (P)

Column and sample	
Type	HP-5, 30 m × 0.32 mm × 0.25 μm (19091J-413)
Sample	FPD checkout (5188-5953)
Column mode	Constant flow
Column flow	6.5 mL/min
Split/splitless inlet	
Temperature	180 °C Split/splitless
Mode	Splitless
Purge flow	60 mL/min
Purge time	0.75 min
Septum purge	3 mL/min
Multimode inlet	
Mode	Splitless
Inlet temperature	75 °C
Initial time	0.1 min
Rate 1	720 °C/min
Final temp 1	250 °C
Final time 1	5.0 min
Purge time	1.0 min
Purge flow	60 mL/min
Septum purge	3 mL/min
Purged packed column inlet	
Temperature	180 °C
Septum purge	3 mL/min
Cool on-column inlet	
Temperature	Track oven
Septum purge	15 mL/min

Table 46 FPD⁺ Checkout Conditions (continued)(P)

PTV inlet	
Mode	Splitless
Inlet temperature	75 °C
Initial time	0.1 min
Rate 1	720 °C/min
Final temp 1	350 °C
Final time 1	2 min
Rate 2	100 °C/min
Final temp 2	250 °C
Final time 2	0 min
Purge time	0.75 min
Purge flow	60 mL/min
Septum purge	3 mL/min
Detector	
Temperature	200 °C (On)
Hydrogen flow	60 mL/min (On)
Air (Oxidizer) flow	60 mL/min (On)
Mode	Constant makeup flow OFF
Makeup flow	60 mL/min (On)
Makeup gas type	Nitrogen
Flame	On
Lit offset	Typically 2 pA
PMT voltage	On
Emission Block	125 °C
Oven	
Initial temp	70 °C
Initial time	0 min
Rate 1	25 °C/min
Final temp 1	150 °C
Final time 1	0 min
Rate 2	5 °C/min
Final temp 2	190 °C
Final time 2	7 min



Table 46 FPD⁺ Checkout Conditions (continued)(P)

ALS settings (if installed)	
Sample washes	2
Sample pumps	6
Sample wash volume	8 (maximum)
Injection volume	1 μ L
Syringe size	10 μ L
Solvent A pre washes	2
Solvent A post washes	2
Solvent A wash volume	8
Solvent B pre washes	0
Solvent B post washes	0
Solvent B wash volume	0
Injection mode (7693A)	Normal
Airgap Volume (7693A)	0.20
Viscosity delay	0
Inject Dispense Speed (7693A)	6000
PreInjection dwell	0
PostInjection dwell	0
Manual injection	
Injection volume	1 μ L
Data system	
Data rate	5 Hz

- 3 Ignite the FPD+ flame, if not lit.
- 4 Display the signal output and monitor. This output typically runs around 10. Wait for the output to stabilize. This takes approximately 1 hour.
If the baseline output is too high:
 - Check column installation. If installed too high, the stationary phase burns in the flame and increases measured output.
 - Check for leaks.
 - Bake out the detector and column at 250 °C.
 - Wrong flows set for installed filter.
 If the baseline output is zero, verify the electrometer is on and the flame is lit.
- 5 If using a data system, prepare the data system to perform one run using the loaded checkout method. Make sure that the data system will output a chromatogram.
- 6 Start the run.

If performing an injection using an autosampler, start the run using the data system or press .

If performing a manual injection (with or without a data system):

- a** Select  to prepare the inlet for splitless injection.
- b** When the GC becomes ready, inject 1 μL of the checkout sample and press .
- c** The following chromatogram shows typical results for a new detector with new consumable parts installed.

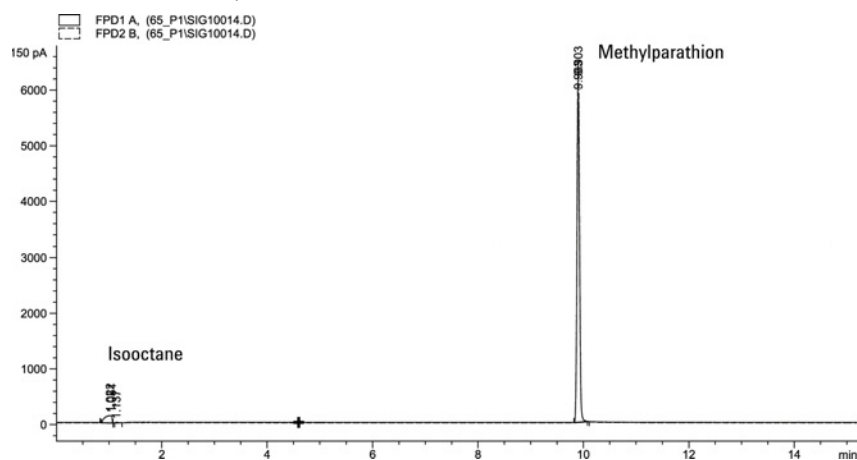

Sulfur performance

- 1 Install the sulfur filter and filter spacer.
- 2 Ignite the FPD+ flame if not lit.
- 3 Display the signal output and monitor. This output typically runs between 50 and 60 but can be as high as 70. Wait for the output to stabilize. This takes approximately 1 hour.

If the baseline output is too high:



- Check column installation. If installed too high, the stationary phase burns in the flame and increases measured output.
- Check for leaks.
- Bake out the detector and column at 250 °C.
- Wrong flows set for installed filter.

If the baseline output is zero, verify the electrometer is on and the flame is lit.

- 4 If using a data system, prepare the data system to perform one run using the loaded checkout method. Make sure that the data system will output a chromatogram.
- 5 Start the run.

If performing an injection using an autosampler, start the run using the data system or press .

If performing a manual injection (with or without a data system):

- a** Select  to prepare the inlet for splitless injection.
- b** When the GC becomes ready, inject 1 μL of the checkout sample and press .

17 Chromatographic Checkout

- 6 The following chromatogram shows typical results for a new detector with new consumable parts installed.

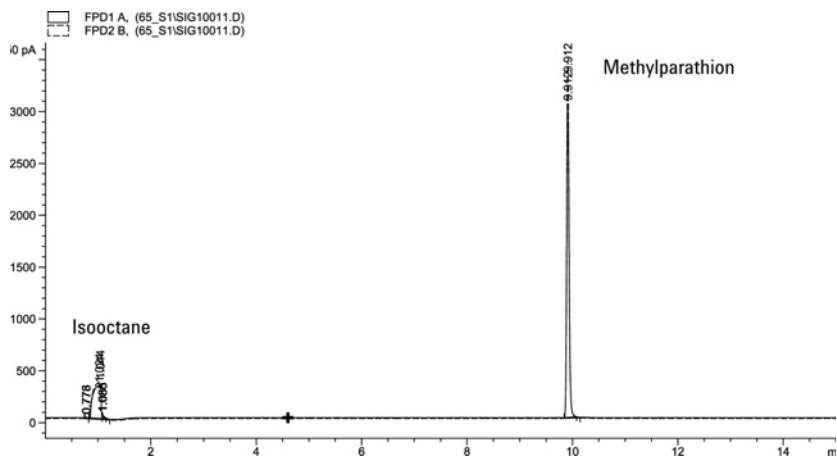

To Check FPD+ Performance (Sample 5188-5245, Japan)

To verify FPD+ performance, first check the phosphorus performance, then the sulfur performance.

Preparation

- 1 Gather the following:
 - Evaluation column, DB5 15 m × 0.32 mm × 1.0 μm (123-5513)
 - FPD performance evaluation (checkout) sample (5188-5245, Japan), composition: n-Dodecane 7499 mg/L (± 5%), Dodecanethiol 2.0 mg/L (± 5%), Tributyl Phosphate 2.0 mg/L (± 5%), tert-Butyldisulfide 1.0 mg/L (± 5%), in isooctane as solvent
 - Phosphorus filter
 - Sulfur filter and filter spacer
 - 4-mL solvent and waste bottles or equivalent for autoinjector.
 - 2-mL sample vials or equivalent for sample.
 - Chromatographic-grade isooctane for syringe wash solvent.
 - Inlet and injector hardware See **“To Prepare for Chromatographic Checkout.”**
- 2 Verify the following:
 - Chromatographic-grade gases plumbed and configured: helium as carrier gas, nitrogen, hydrogen, and air.
 - Empty waste vials loaded in sample turret.
 - 4-mL vial with diffusion cap filled with isooctane and inserted in Solvent A injector position.
- 3 Replace consumable parts (liner, septum, traps, syringe, and so forth) as needed for the checkout. See **“To Prepare for Chromatographic Checkout.”**
- 4 Verify the lit offset is set appropriately. Typically, it should be about 2.0 pA for the checkout method.
- 5 Install the evaluation column.
 - Set the oven, inlet, and detector to 250 °C and bake out for at least 15 minutes.
- 6 Configure the column.

Phosphorus performance

- 1 If it is not already installed, install the phosphorus filter.
- 2 Create or load a method with the parameter values listed in **Table 47**.

Table 47 FPD⁺ Phosphorus Checkout Conditions

Column and sample	
Type	DB-5MS, 15 m × 0.32 mm × 1.0 μm (123-5513)
Sample	FPD checkout (5188-5245)
Column mode	Constant flow
Column flow	7.5 mL/min
Split/splitless inlet	
Temperature	250 °C
Mode	Splitless
Total purge flow	69.5 mL/min
Purge flow	60 mL/min
Purge time	0.75 min
Septum purge	3 mL/min
Multimode inlet	
Mode	Splitless
Inlet temperature	80 °C
Initial time	0.1 min
Rate 1	720 °C/min
Final temp 1	250 °C
Final time 1	5.0 min
Purge time	1.0 min
Purge flow	60 mL/min
Septum purge	3 mL/min
Purged packed column inlet	
Temperature	250 °C
Septum purge	3 mL/min
Cool on-column inlet	
Temperature	Oven track
Septum purge	15 mL/min

Table 47 FPD⁺ Phosphorus Checkout Conditions (continued)

PTV inlet	
Mode	Splitless
Inlet temperature	80 °C
Initial time	0.1 min
Rate 1	720 °C/min
Final temp 1	350 °C
Final time 1	2 min
Rate 2	100 °C/min
Final temp 2	250 °C
Final time 2	0 min
Purge time	0.75 min
Purge flow	60 mL/min
Septum purge	3 mL/min
Detector	
Temperature	200 °C (On)
Hydrogen flow	60.0 mL/min (On)
Air (oxidizer) flow	60.0 mL/min (On)
Mode	Constant makeup flow Off
Makeup flow	60.0 mL/min (On)
Makeup gas type	Nitrogen
Flame	On
Lit offset	Typically 2 pA
PMT voltage	On
Emission Block	125 °C
Oven	
Initial temp	70 °C
Initial time	0 min
Rate 1	10 °C/min
Final temp	105 °C
Final time	0 min
Rate 2	20 °C/min
Final temp 2	190 °C
Final time 2	7.25 min for sulfur 12.25 min for phosphorus



Table 47 FPD⁺ Phosphorus Checkout Conditions (continued)

ALS settings (if installed)	
Sample washes	2
Sample pumps	6
Sample wash volume	8 (maximum)
Injection volume	1 μ L
Syringe size	10 μ L
Solvent A pre washes	2
Solvent A post washes	2
Solvent A wash volume	8
Solvent B pre washes	0
Solvent B post washes	0
Solvent B wash volume	0
Injection mode (7693A)	Normal
Airgap Volume (7693A)	0.20
Viscosity delay	0
Inject Dispense Speed (7693A)	6000
PreInjection dwell	0
PostInjection dwell	0
Manual injection	
Injection volume	1 μ L
Data System	
Data rate	5 Hz

- 3 Ignite the FPD+ flame, if not lit.
- 4 Display the signal output and monitor. This output typically runs around 10. Wait for the output to stabilize. This takes approximately 1 hour.
If the baseline output is too high:
 - Check column installation. If installed too high, the stationary phase burns in the flame and increases measured output.
 - Check for leaks.
 - Bake out the detector and column at 250 °C.
 - Wrong flows set for installed filter.
 If the baseline output is zero, verify the electrometer is on and the flame is lit.
- 5 If using a data system, prepare the data system to perform one run using the loaded checkout method. Make sure that the data system will output a chromatogram.
- 6 Start the run.

If performing an injection using an autosampler, start the run using the data system or press .

If performing a manual injection (with or without a data system):

- a Select  to prepare the inlet for splitless injection.
- b When the GC becomes ready, inject 1 μL of the checkout sample and press .

- 7 The following chromatogram shows typical results for a new detector with new consumable parts installed.

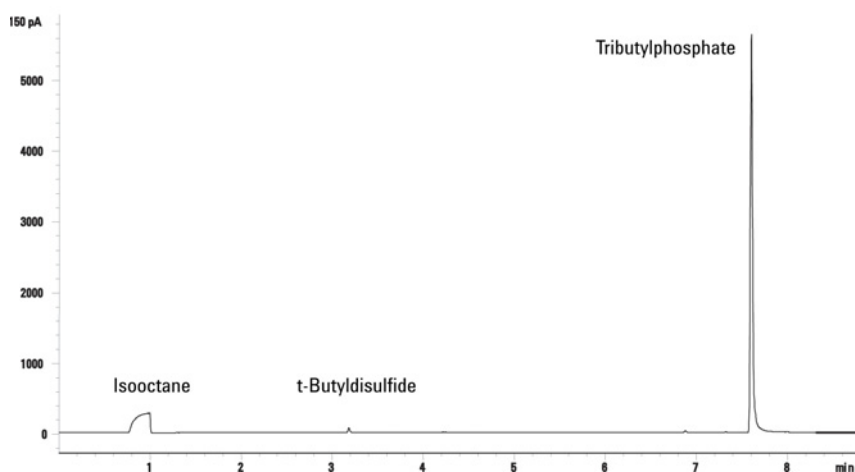

Sulfur performance

- 1 Install the sulfur filter.
- 2 Ignite the FPD+ flame, if not lit.
- 3 Display the signal output and monitor. This output typically runs between 50 and 60 but can be as high as 70. Wait for the output to stabilize. This takes approximately 2 hours.

If the baseline output is too high:



- Check column installation. If installed too high, the stationary phase burns in the flame and increases measured output.
- Check for leaks.
- Bake out the detector and column at 250 °C.
- Wrong flows set for installed filter

If the baseline output is zero, verify the electrometer is on and the flame is lit.

- 4 If using a data system, prepare the data system to perform one run using the loaded checkout method. Make sure the data system will output a chromatogram.
- 5 Start the run.

If performing an injection using an autosampler, start the run using the data system or press .

If performing a manual injection (with or without a data system):

- a Select  to prepare the inlet for splitless injection.
- b When the GC becomes ready, inject 1 μL of the checkout sample and press .

17 Chromatographic Checkout

- 6 The following chromatogram shows typical results for a new detector with new consumable parts installed.

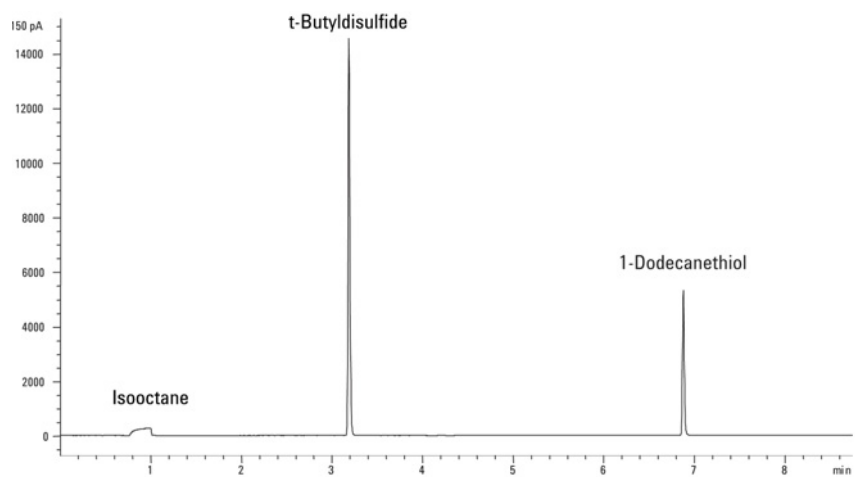

FPD+ and ECD Unit Conversion Factors **268**

 Conversion factors for the FPD+ **268**

 Conversion factor for the ECD **268**

Using the Conversion Factors **270**

References **271**

The 8890 GC complies with the following company standard: Q31/0115000033C005-2016-02.

China Metrology testing of the 8890 GC is performed in accordance with company standard Q31/0115000033C005-2016-02. This chapter provides information and techniques to correctly identify noise and drift when testing an FPD+ or ECD.

FPD+ and ECD Unit Conversion Factors

At the time of publication, China Metrology testing requires noise and drift metrics as shown below:

Detector	Reporting units
FID	A
TCD	mV
NPD	A
FPD+	A
ECD	mV

However, data collection is required to come through the digital output available through the GC and data system. For the FID, NPD, and TCD, the data system provides data in the desired reporting units. However, for the ECD and FPD+, Agilent reports output to its data systems in "display units," (DU). This section describes how to accurately convert/scale the FPD+ and ECD digital results to make them consistent with Chinese Metrology requirements.

The conversion factors for the FPD+ and ECD take the display unit output from the Agilent data system digital path to an absolute value for current or voltage. Agilent developed the conversion factors empirically, based on measurements from a single system that simultaneously output both the digital and analog data. The conversion factors also incorporate:

- The scaling applied to analog versus digital signals
- An analog signal range setting of 5 (2⁵) at the GC
- The unique filtering applied by the 35900 ADC
- The differences in bandwidth (BW) associated with the GC digital channel (5 Hz) and the 35900 ADC analog path (3 Hz)

The differences in channel bandwidth between the analog and digital signal paths can be taken into consideration as follows:

$$BW = 35900 \text{ ADC path} / \text{GC digital path} = \sqrt{(3 \text{ Hz} / 5 \text{ Hz})} = 0.7$$

Conversion factors for the FPD+

For the FPD+, the conversion factor is the same whether the phosphorus or sulfur filter is used:

$$\text{FPD+ (phosphorus): } 1 \text{ DU} = 1 \times 10^{-12} \text{ A}$$

$$\text{FPD+ (sulfur): } 1 \text{ DU} = 1 \times 10^{-12} \text{ A}$$

Conversion factor for the ECD

For the ECD, the China Metrology standard was established based on an earlier model ECD. Agilent relates display units and Hz (the base unit of measure for the ECD) at a different ratio for the ECD compared to the ECD used to develop the standard. The ECD correlates a DU to 1 Hz, whereas the older ECD correlates 1 DU to 5 Hz. Therefore the conversion also includes the difference in the digital signal reporting between the ECD and the ECD. To convert the ECD noise output into a value comparable to the CMC specification, use the following formula:

18 Chinese Metrology Testing

ECD: 1 DU = 0.2 mV

The ECD conversion factor shows that the comparable conversion factor for the ECD would be
 $1 \text{ mV/DU} = 1 \text{ mV/1 Hz}$.

Using the Conversion Factors

To use the conversion factors, multiply the ASTM noise reported from the Agilent data system for the GC digital signal path by the appropriate conversion factor.

For example, consider applying the FPD+ and ECD conversion factors to a statistical sampling of digital noise performances measured for both detectors at Agilent:

Average FPD+ ASTM noise, DU¹²: 1.54

Average ECD ASTM noise, DU³: 0.16

Applying the conversion factors:

FPD+: $1.54 \text{ DU} \times (1 \times 10^{-12} \text{ A/1 DU}) = 1.54 \times 10^{-12} \text{ A}$

ECD: $0.16 \text{ DU} \times (0.2 \text{ mV/1 DU}) = 0.032 \text{ mV}$

- 1 Agilent data for FPD+ noise in this example represents sulfur mode only.
- 2 Data collected for purposes of comparison should be acquired with a nominal FPD+ offset of < 100 DU in sulfur mode and < 20 DU in phosphorus mode and at a data rate of 5 Hz.
- 3 Data collected for purposes of comparison should be acquired with a nominal ECD baseline at or below 150 DU and at a data rate of 5 Hz.

References

"Calculation of Performance Factors for the HP 6890 Gas Chromatograph Using Different Data Handling Devices" Agilent Technologies publication 5964-0282E.

"Calculation of Performance Factors for the HP 6890 Gas Chromatograph Using Different Data Handling Devices" Agilent Technologies publication 5091-9207E.

"Calculation of Performance Factors for the HP 6890 Gas Chromatograph Using Different Data Handling Devices" Agilent Technologies publication 5965 8901E.

The terms in **Table 48** are used in discussing this product. They are collected here for your convenience.

Table 48 Terms

Term	Definition
ADC	Analog to digital converter
ALS	Automatic liquid sampler
AS	Autosampler
BCD	Binary coded decimal
COC	Cool on column inlet
DHCP	Dynamic host creation protocol
ECD	Electron capture detector
ELVDS	Port for external communications with Agilent MSDs
EMF	Early maintenance feedback
EPC	Electronic pneumatics control
FID	Flame ionization detector
FPD+	Flame photometric detector plus
GC	Gas chromatograph
HS	Headspace sampler
LAN	Local area network
LTM	Low thermal mass
LUI	Local User Interface
LVDS	Low-voltage differential signaling
MMI	Multi-mode inlet
MS	Mass spectrometer
MSD	Mass selective detector
NCD	Nitrogen chemiluminescence detector
NPD	Nitrogen-phosphorus detector
NTP	Normal temperature and pressure (25 °C and 1 atmosphere)
PCI	Packed column inlet
PCM	Pressure Control Module
PID	Proportional integral and differential
PP	Purged packed inlet
PSD	Pneumatic switching device

Table 48 Terms (continued)

Term	Definition
PTFE	Polytetrafluoroethylene
PTV	Programmed temperature vaporization inlet
QTOF	Quadrupole Time-of-Flight
SCD	Sulfur chemiluminescence detector
Smart ID Key	Attached to critical flow path components, smart ID keys provide information such as configuration and column age with default parameters for configuration
SSL	Split/splitless inlet
TCD	Thermal conductivity detector

This page intentionally left blank.

www.agilent.com

© Agilent Technologies, Inc. 2019

Third edition, January 2020



G3540-90014

